

Ratings

Voltage: 300 V
 Temperature
 Static: -40 ~ 105 °C
 Dynamic: -20 to 105 °C
 Flammability: VW-1
 Water resistant: 75 °C
 Oil resistant: 60 °C (jacket)
 ≥50% elongation and tensile strength after aging
 UV resistance: jacket, 720 hours xenon or carbon arc exposure
 ≥80% tensile strength and elongation after aging

Conductor

Conductor count: 10
 Gauge: 28 AWG 0.09 mm²
 Material: tinned copper strands
 Strand size: Ø 0.127 mm x 7
 Resistance at 20 °C: 239 Ω /km Max

Insulator

Material: PVC
 Color: red, black, white, yellow, blue, green, orange, purple, gray, brown
 Diameter: Ø 1.2 ±0.10 mm
 Nominal thickness: 0.38 mm
 Resistance at 20 °C: 10 MΩ /km Min

Filler

Material: cotton rope

Drain

Stranding: Ø 0.127 mm x 7
 Material: tinned copper strands

Shield

Type: aluminum mylar + tinned copper braid
 Coverage: 65% min braid, 100% foil
 Braid stranding: Ø0.10 mm

Outer jacket

Material: PVC, 80A
 Color: black
 Diameter: Ø 6.9 ±0.30 mm
 Nominal thickness: 0.80 mm

Wire marking: E339579 UL AWM STYLE 20387 28 AWG 105°C 300V VW-1 60°C OIL RESISTANT UV RESISTANT TENSILITY

Use: External wiring

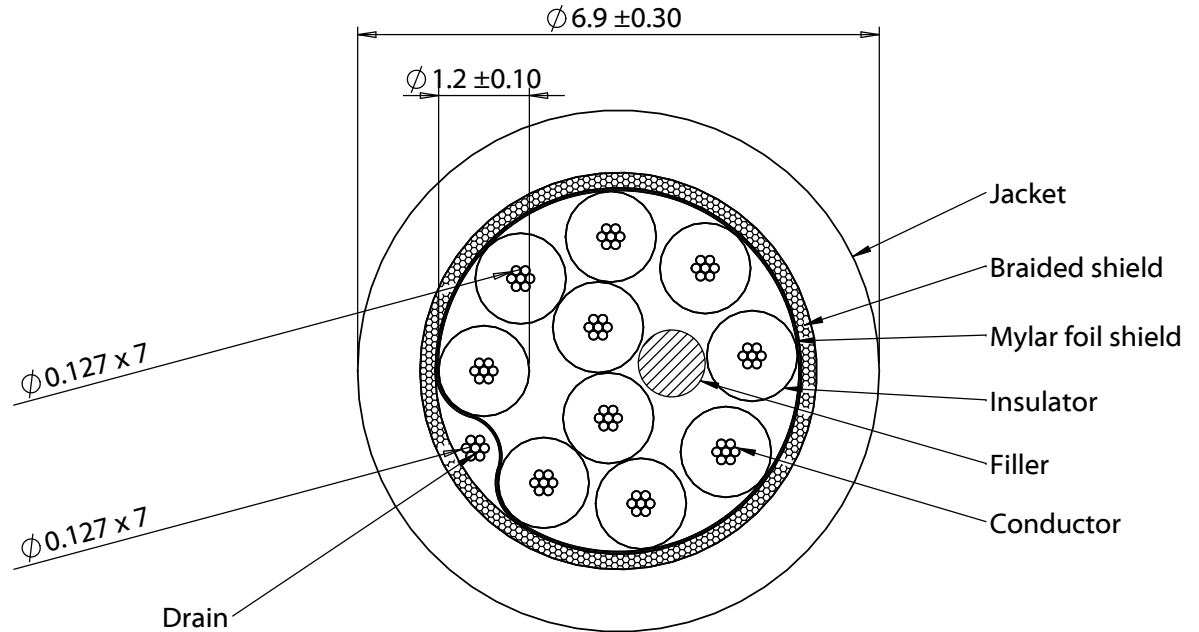
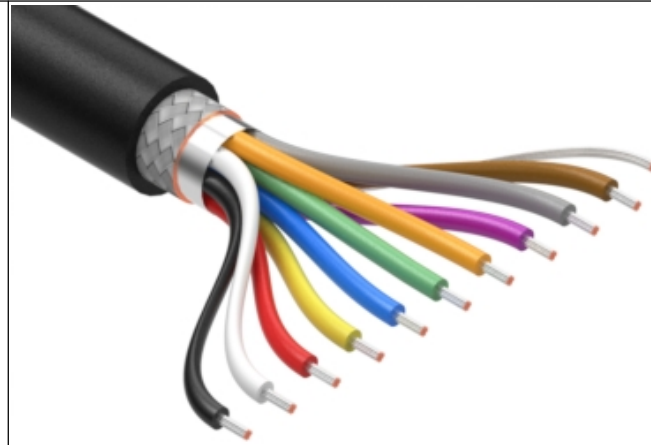

Revision:	Date:	Description:	Prepared:	Notes:	<h1>TENSILITY</h1> <p>tel 1.541.323.3228 800 877.670.7118 fax 1.541.323.4202 web tensility.com</p>
A	8/25/2020	Initial release	Verified:	RoHS compliant Function test: no open, no short circuit, no intermittent	
			Dimensions are in millimeters. Tolerances: X: ± 0.5 mm X.X: ± 0.3 mm X.XX: ± 0.05 mm	Description: Wire, 10C TS, 28 AWG, UL20387, 300V, 105C, 60C oil, UV, 6.9 mm, shielded, VW-1, PVC, 80A, black	Size: A Part number: 30-01629
					Scale: 10:1 Sheet 1 of 1

5

4

3

2

1