

PLEASE CHECK WWW.MOLEX.COM FOR LATEST PART INFORMATION

Part Number: [53358-0940](#)
Status: **Active**
Description: 2.00mm Pitch Mi II™ Wire-to-Wire Adapter, 9 Circuits, Lead-Free

Documents:

[3D Model](#) [Product Specification PS-53358-001 \(PDF\)](#)
[Drawing \(PDF\)](#) [RoHS Certificate of Compliance \(PDF\)](#)
[Product Specification PS-51090-003 \(PDF\)](#)

Agency Certification

CSA LR19980
 UL E29179

General

Product Family Accessories
 Series [53358](#)
 Comments For Panel Mounting
 Component Type Adapter
 Product Name Mi II™
 UPC 756054585009

Physical

Circuits (Loaded) 9
 Color - Resin Natural
 Flammability 94V-0
 Gender N/A
 Lock to Mating Part Yes
 Material - Metal Brass
 Material - Plating Mating Tin
 Material - Plating Termination Tin
 Material - Resin Polyester
 Net Weight 1359.300/mg
 Number of Rows 1
 Packaging Type Bag
 Plating min - Mating 1.016µm
 Plating min - Termination 1.016µm
 Polarized to Mating Part Yes
 Temperature Range - Operating -40°C to +105°C

Electrical

Current - Maximum per Contact 2A

Material Info

Reference - Drawing Numbers

Product Specification PS-51090-003, PS-53358-001, RPS-53358-001
 Sales Drawing SD-53358-001

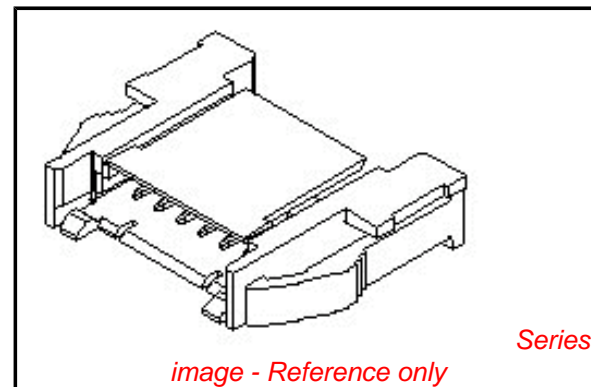

image - Reference only

EU RoHS

**ELV and RoHS
 Compliant**
**REACH SVHC
 Contains SVHC: No**
**Low-Halogen Status
 Not Low-Halogen**

China RoHS



**Need more information on product
 environmental compliance?**

Email productcompliance@molex.com
 For a multiple part number RoHS Certificate of
 Compliance, [click here](#)

Please visit the [Contact Us](#) section for any
 non-product compliance questions.

Search Parts in this Series

[53358Series](#)

Use With

[51090 Crimp Housing](#), [52484 IDT Housing](#)