

APPROVED: \_\_\_\_\_  
 DATE: \_\_\_\_\_ TITLE: \_\_\_\_\_

Rev	AWO #	Description	Date	Appr
-		RELEASED	4/11/17	
A		UPDATE DRAWING	5/29/20	LH/RC

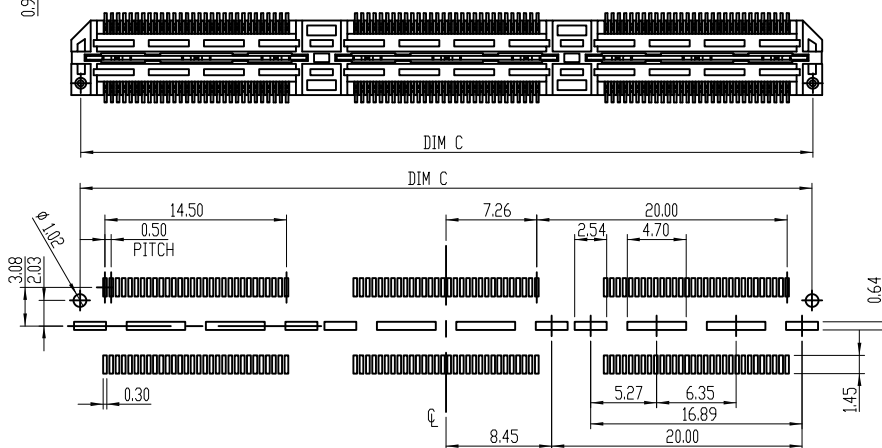
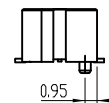
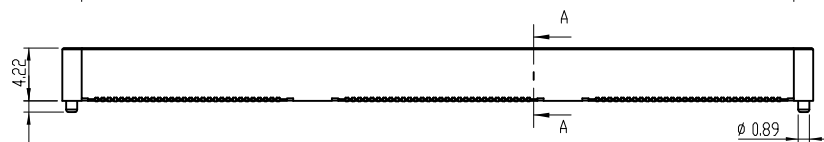
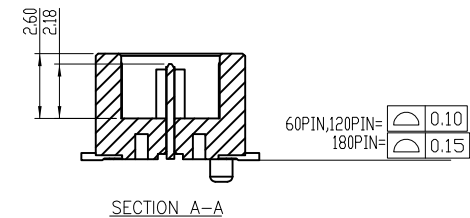
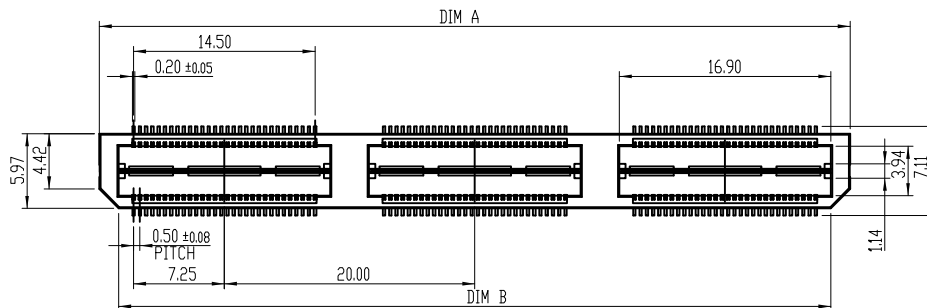

	60 PIN	120 PIN	180 PIN
DIM A	20.00	40.00	60.00
DIM B	16.90	36.90	56.90
DIM C	18.48	38.48	58.48

Mated with: BB5H-SC-XXX-G-2.05-HF-T/R

**SPECIFICATIONS:**

Material:  
 Insulator: Hi-Temp thermoplastic, rated UL 94V-0  
 Insulator color: Black  
 Contacts: Copper Alloy  
 Plating:  
 8u" Gold over Nickel underplate on contact area  
 1u" Gold over Nickel underplate on solder tails  
 Electrical:  
 Current Rating: Contact: 2.0A  
 Ground Plane: 7.8A  
 Voltage Rating: 175VAC (5mm Stack Height)  
 Dielectric withstanding voltage: 525 VAC  
 Mating cycles: 100 insertions  
 Temperature Rating:  
 Temperature: -55°C to +125°C  
 Environmental:  
 Lead free, RoHS compliant

RECOMMENDED P.C.B LAYOUT

PACKAGED ON TAPE & REEL

UNLESS OTHERWISE SPECIFIED ALL DIMENSIONS ARE MILLIMETERS TOLERANCES: EXCEPT AS NOTED MM ANG .X ± .30 ± 2° .X ± .15 .XX + .12		<b>ADAM TECH</b> INTERCONNECTS 909 Rahway Avenue, Union, NJ 07083 Phone: 908-687-5000 Fax: 908-687-5710	
APPROVALS DRAWN AY CHECKED OC APPROVED		DATE 4/11/17 4/11/17	
TITLE <b>HI-SPEED GROUND PLANE .020 [0.50] PITCH          BOARD TO BOARD PLUG, SMT TYPE</b>		SIZE <b>X</b>	PART NO. <b>BB5H-PC-XXX-G-4.27-HF-T/R</b>
REF: S00013T		SCALE: NTS	SHEET 1 OF 3



APPROVED: \_\_\_\_\_  
 DATE: \_\_\_\_\_ TITLE: \_\_\_\_\_

Rev	AWO #	Description	Date	Appr
SEE SHT 1 OF 3 FOR REVISION				

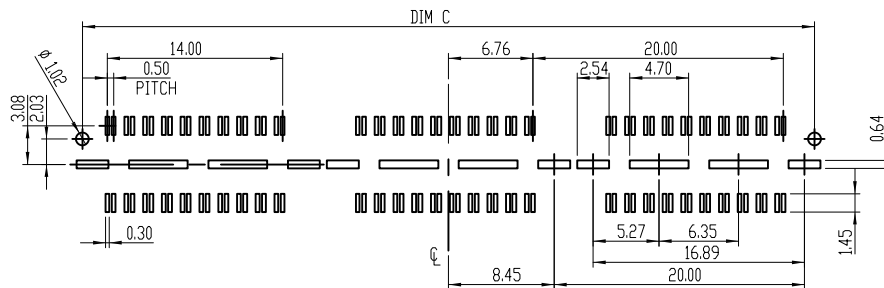
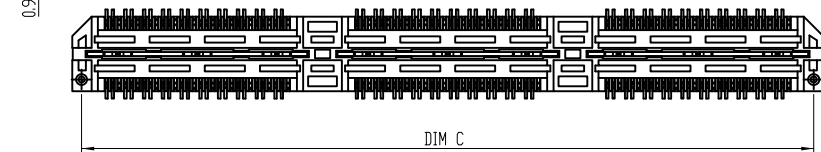
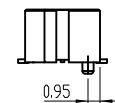
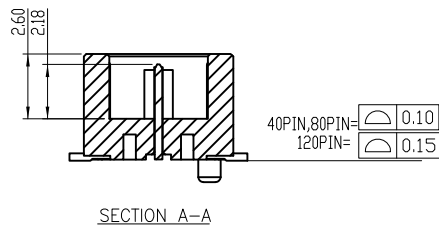
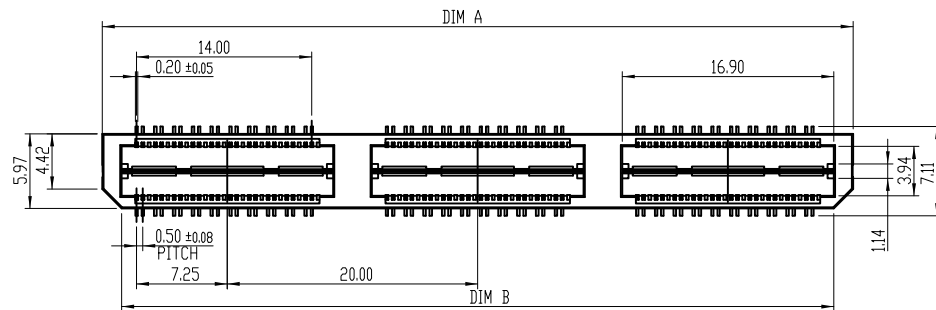

	40 PIN	80 PIN	120A PIN
DIM A	20.00	40.00	60.00
DIM B	16.90	36.90	56.90
DIM C	18.48	38.48	58.48

Mated with: BB5H-SC-XXX-G-2.05-HF-T/R

RECOMMENDED P.C.B LAYOUT

PACKAGED ON TAPE & REEL

UNLESS OTHERWISE SPECIFIED  
 ALL DIMENSIONS ARE MILLIMETERS  
 TOLERANCES: EXCEPT AS NOTED  
 MM ANG  
 X. ± .30 ± 2°  
 .X ± .15  
 .XX + .12

**ADAM TECH**  
 INTERCONNECTS  
 909 Rahway Avenue,  
 Union, NJ 07083  
 Phone: 908-687-5000  
 Fax: 908-687-5710

APPROVALS		DATE
DRAWN	AY	4/11/17
CHECKED	OC	4/11/17
APPROVED		

TITLE  
**HI-SPEED GROUND PLANE .020 [0.50] PITCH  
 BOARD TO BOARD PLUG, SMT TYPE**

SIZE X	PART NO. BB5H-PC-XXX-G-4.27-HF-T/R	REV. A
REF: S00013T	SCALE: NTS	SHEET 2 OF 3

6

5

4

3

2

1

6

5

4

3

2

1

6

5

4

3

2

1

APPROVED: \_\_\_\_\_

DATE: \_\_\_\_\_ TITLE: \_\_\_\_\_

Rev	AWO #	Description	Date	Appr
-----	-------	-------------	------	------

SEE SHT 1 OF 3 FOR REVISION

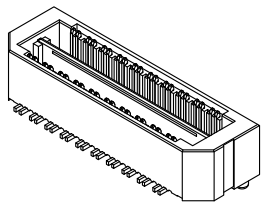

40 PIN

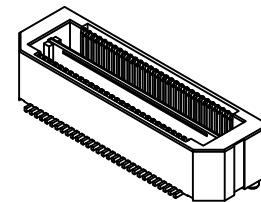

60 PIN

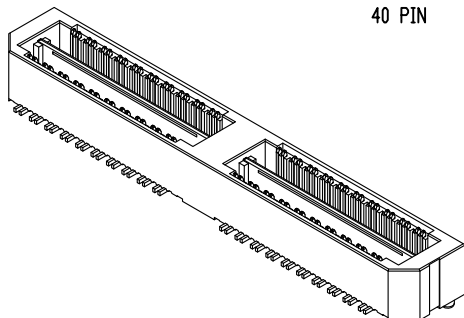

80 PIN

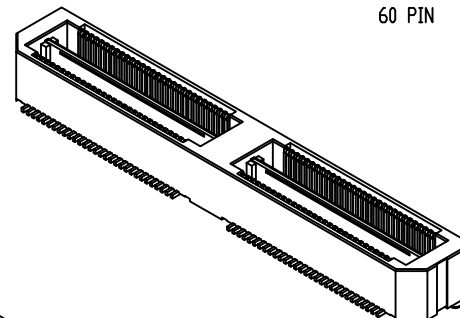

120 PIN

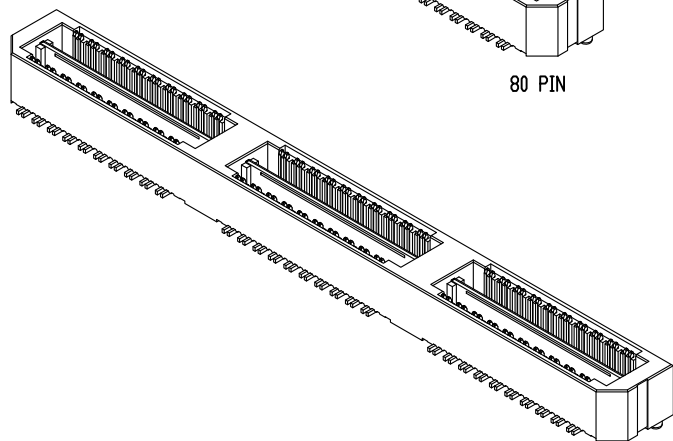

120A PIN

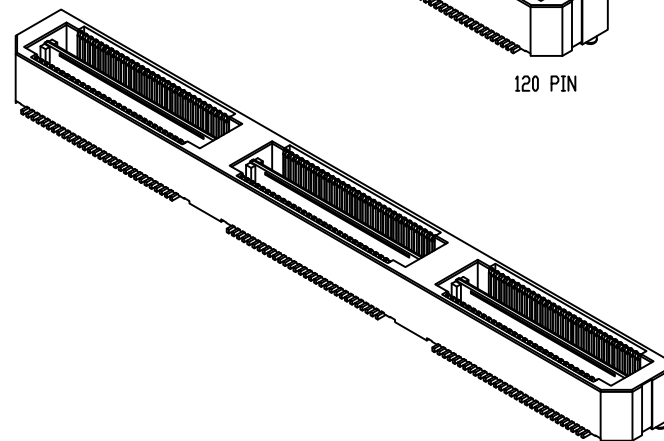

180 PIN

UNLESS OTHERWISE SPECIFIED  
 ALL DIMENSIONS ARE MILLIMETERS  
 TOLERANCES: EXCEPT AS NOTED

MM	ANG
X. ± .30	± 2'
.X ± .15	
.XX + .12	

**ADAM**  
**TECH**  
 INTERCONNECTS

909 Rahway Avenue,  
 Union, NJ 07083  
 Phone: 908-687-5000  
 Fax: 908-687-5710

APPROVALS		DATE
DRAWN	AY	4/11/17
CHECKED	OC	4/11/17
APPROVED		

TITLE  
**HI-SPEED GROUND PLANE .020 [0.50] PITCH  
 BOARD TO BOARD PLUG, SMT TYPE**

SIZE X	PART NO. BB5H-PC-XXX-G-4.27-HF-T/R	REV. A
REF: S00013T	SCALE: NTS	SHEET 3 OF 3

6

5

4

3

2

1

D

D

C

C

B

B

A

A