

# SDCH1V80

## Semi-shielded power inductors

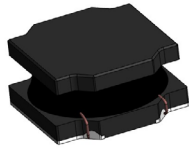

### Product features

- High current carrying capacity
- High power density, low core losses
- Magnetically semi-shielded
- 8.3 mm x 8.3 mm surface mount package in 4.2 mm height
- NiZn ferrite magnetic material
- Moisture sensitivity level (MSL): 1

### Applications

- DC-DC converters
- Switching controllers
- Industrial IoT equipment
- Game consoles
- Portable electronics
- Laptops, notebooks, and netbooks
- Desktops and workstations
- Battery backup
- LED lighting
- HD televisions and displays

### Environmental compliance and general specifications

- Storage temperature range (component): -40 °C to +125 °C
- Operating temperature range: -40 °C to +125 °C (ambient plus self-temperature rise)
- Solder reflow temperature: J-STD-020 (latest revision) compliant



Product specifications

Part number <sup>5</sup>	OCL <sup>1</sup> ( $\mu$ H)	FLL <sup>2</sup> ( $\mu$ H) minimum	I <sub>rms</sub> <sup>3</sup> (A)	I <sub>pk</sub> <sup>4</sup> (A)	DCR (m $\Omega$ ) @ +20 °C nominal	DCR (m $\Omega$ ) @ +20 °C maximum
SDCH1V8040-1R0N-R	1.0 $\pm$ 30%	0.46	8.0	12.0	6.5	9
SDCH1V8040-1R5N-R	1.5 $\pm$ 30%	0.68	7.3	9.6	7.5	11
SDCH1V8040-2R2M-R	2.2 $\pm$ 20%	1.14	6.9	9.3	10	13
SDCH1V8040-3R3M-R	3.3 $\pm$ 20%	1.72	5.0	8.6	15	19
SDCH1V8040-4R7M-R	4.7 $\pm$ 20%	2.44	4.7	6.3	18	21
SDCH1V8040-6R8M-R	6.8 $\pm$ 20%	3.54	3.8	5.1	26	30
SDCH1V8040-100M-R	10 $\pm$ 20%	5.2	3.0	4.6	40	46
SDCH1V8040-150M-R	15 $\pm$ 20%	7.8	2.8	3.2	50	58
SDCH1V8040-220M-R	22 $\pm$ 20%	11.44	2.5	2.8	70	81
SDCH1V8040-330M-R	33 $\pm$ 20%	17.16	1.9	2.2	110	127
SDCH1V8040-470M-R	47 $\pm$ 20%	24.44	1.8	2.0	140	161
SDCH1V8040-680M-R	68 $\pm$ 20%	35.36	1.3	1.6	215	247
SDCH1V8040-101M-R	100 $\pm$ 20%	52.0	1.1	1.22	300	345
SDCH1V8040-221M-R	220 $\pm$ 20%	114.4	0.75	0.9	680	782
SDCH1V8040-331M-R	330 $\pm$ 20%	171.6	0.6	0.7	1000	1150
SDCH1V8040-471M-R	470 $\pm$ 20%	244.4	0.5	0.65	1500	1725
SDCH1V8040-681M-R	680 $\pm$ 20%	353.6	0.42	0.53	2200	2530
SDCH1V8040-821M-R	820 $\pm$ 20%	426.4	0.4	0.45	2500	2875
SDCH1V8040-102M-R	1000 $\pm$ 20%	520.0	0.37	0.42	2900	3335

1. Open circuit inductance (OCL) test parameters: 100 kHz, 0.25 Vrms, 0.0 Adc, +25 °C

2. Full load inductance (FLL) test parameters: 100 kHz, 0.25 Vrms, I<sub>pk</sub>, +25 °C

3. I<sub>rms</sub>: DC current for an approximate temperature rise of 40 °C without core loss. Derating is necessary for AC currents. PCB layout, trace thickness and width, air-flow, and proximity of other heat generating components will affect the temperature rise. It is recommended that the temperature of the part not exceed +125 °C under worst case operating conditions verified in the end application.

4. I<sub>pk</sub>: Peak current for approximately 35% maximum rolloff @ +25 °C

5. Part number definition: SDCH1Vxxx-yyyz-R

SDCH1V = Product code  
xxx= size code  
yyy= Inductance value in  $\mu$ H, R=decimal point  
z= Inductance tolerance  
-R suffix = RoHS compliant

Dimensions-mm

SDCH1V8040

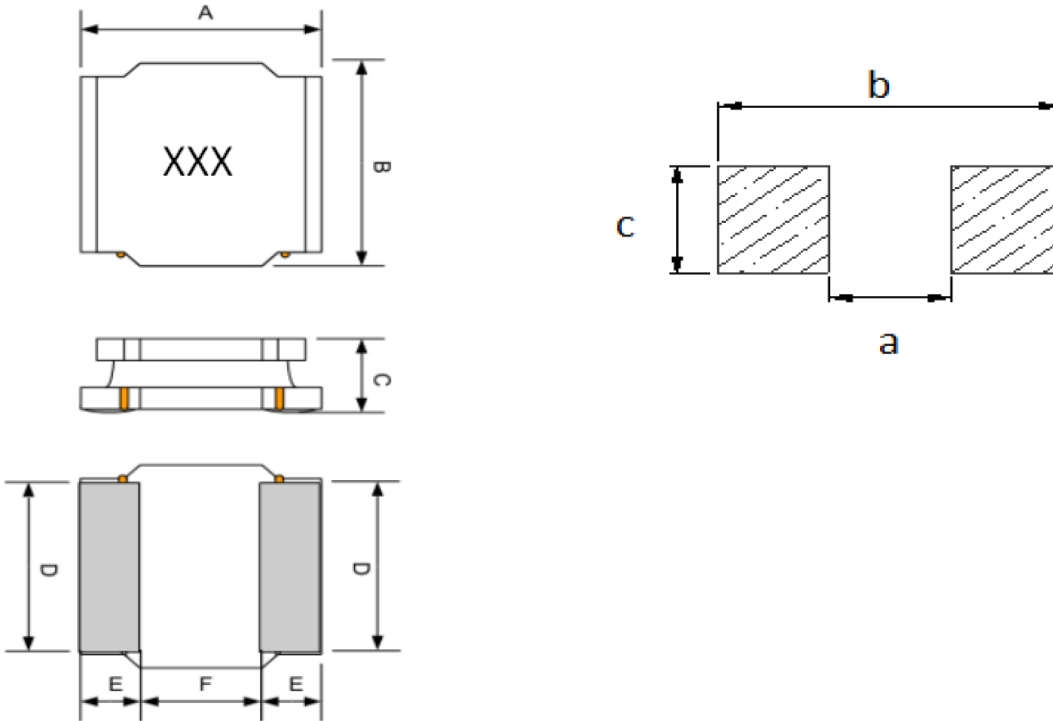

Dimension	Value
A	8.0 ± 0.3
B	8.0 ± 0.3
C	4.2 MAX
D	6.3 ± 0.2
E	2.45 ± 0.3
F	3.1 ± 0.3
a	2.8 TYP
b	8.3 TYP
c	6.6 TYP

Part marking: xxx= inductance value in  $\mu\text{H}$ , R= decimal point. If no R is present then last character equals number of zeros.  
 Tolerances are  $\pm 0.3$  millimeters unless stated otherwise  
 All soldering surfaces to be coplanar within 0.1 millimeters  
 Pad layout tolerances are  $\pm 0.1$  millimeters unless stated otherwise  
 Traces or vias underneath the inductor is not recommended

**Packaging information- mm**

**SDCH1V8040**

Supplied in tape and reel packaging, 1000 parts per 13" diameter reel (EIA-481 compliant)

Drawing not to scale

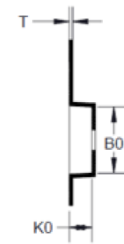
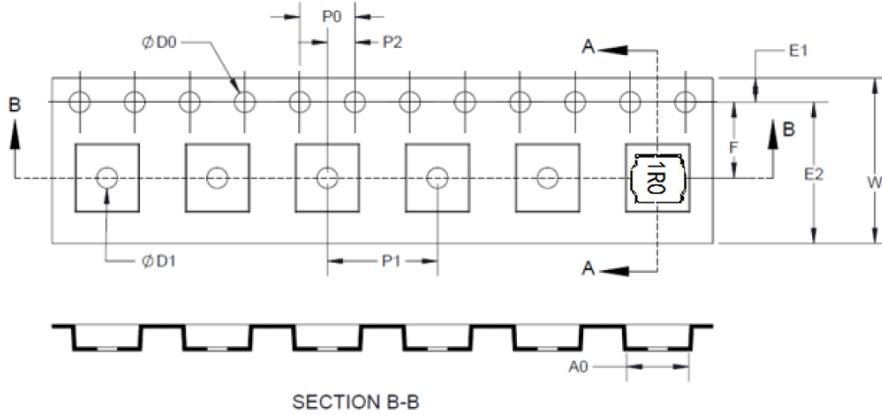

SECTION A-A

Dimension	Value
W	16.00 + 0.20/-0.30
F	7.50 ± 0.10
E1	1.75 ± 0.10
E2	N/A
P0	4.00 ± 0.10
P1	12.00 ± 0.10
P2	2.00 ± 0.10
ØD0	1.55 ± 0.05
ØD1	1.55 ± 0.05
A0	8.55 ± 0.10
B0	8.55 ± 0.10
K0	4.40 ± 0.10
T	0.40 ± 0.05

Inductance and temperature rise vs current

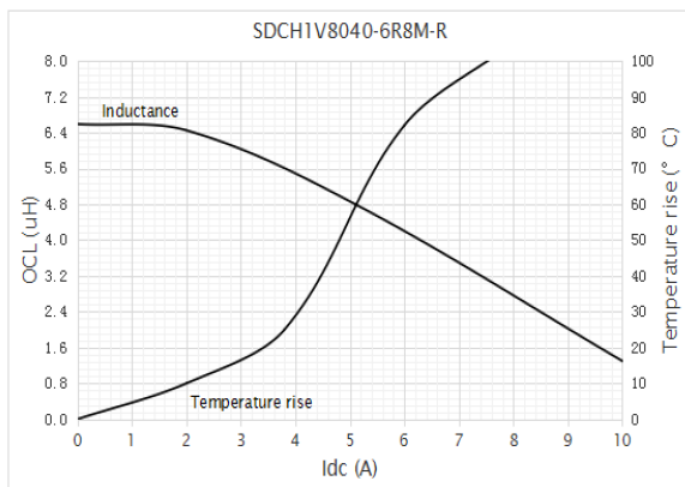
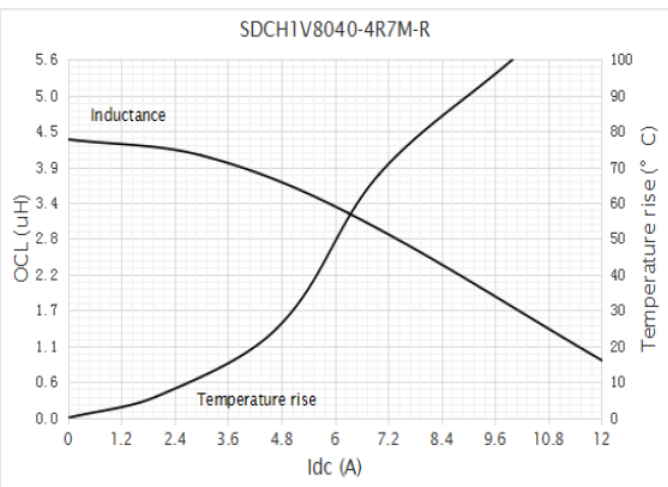
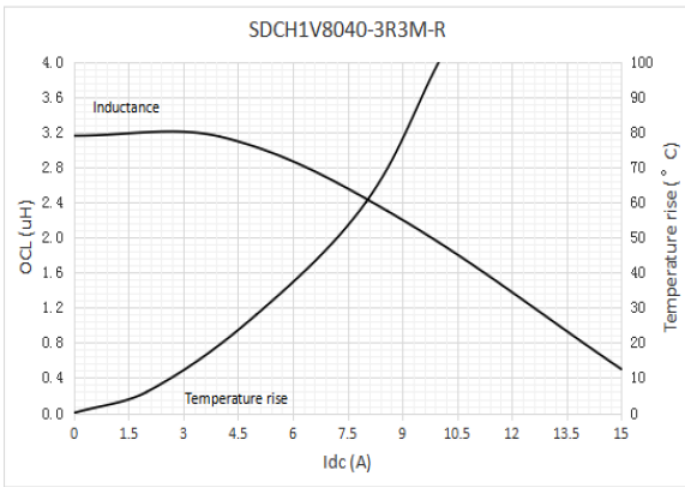
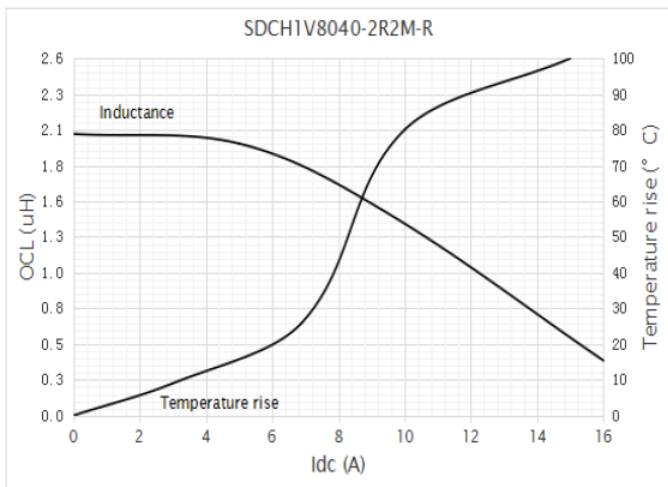
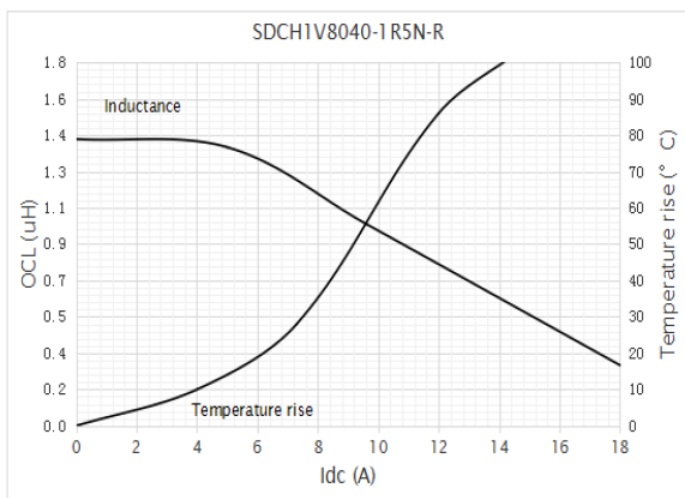
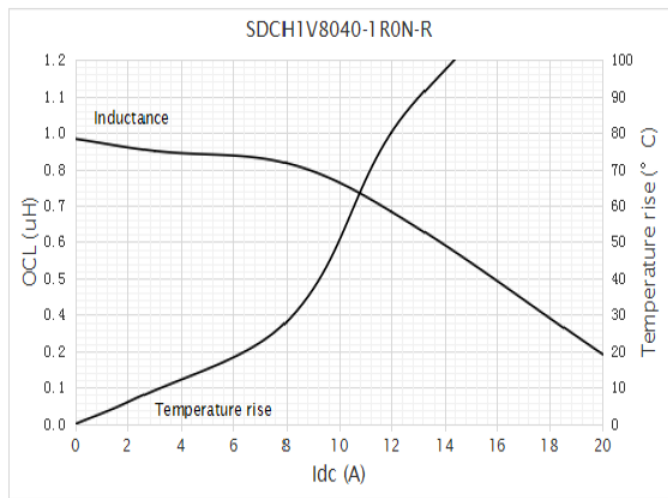

Inductance and temperature rise vs current

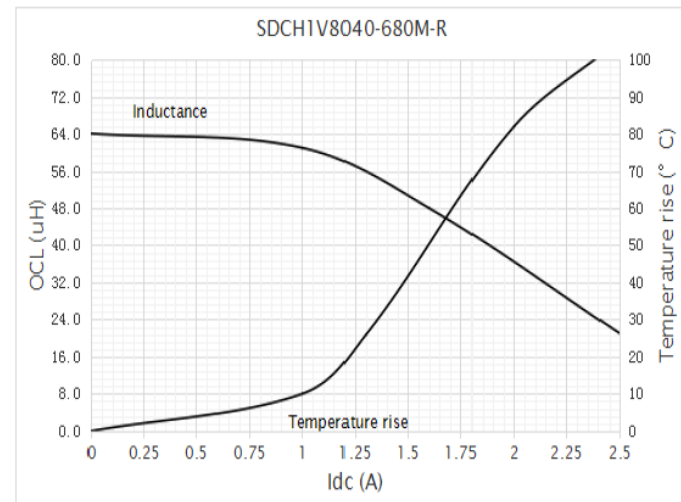
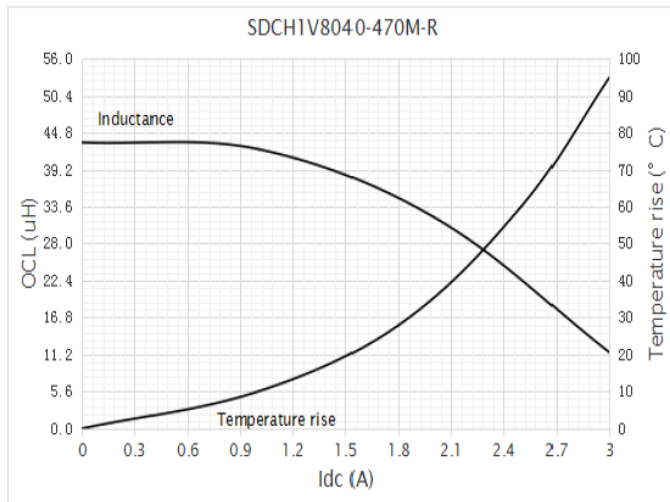
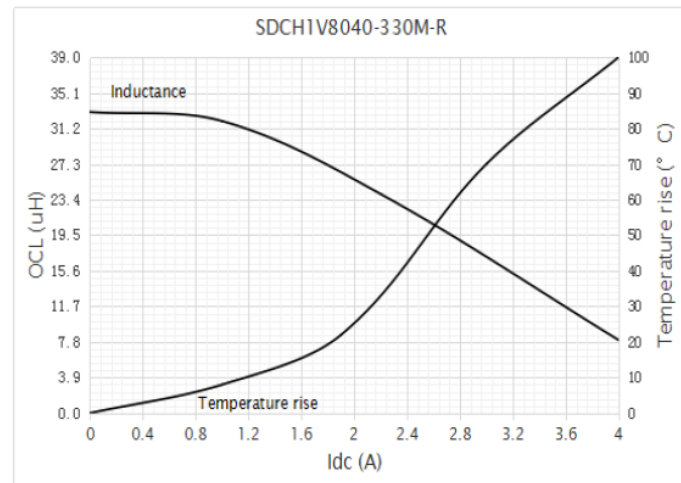
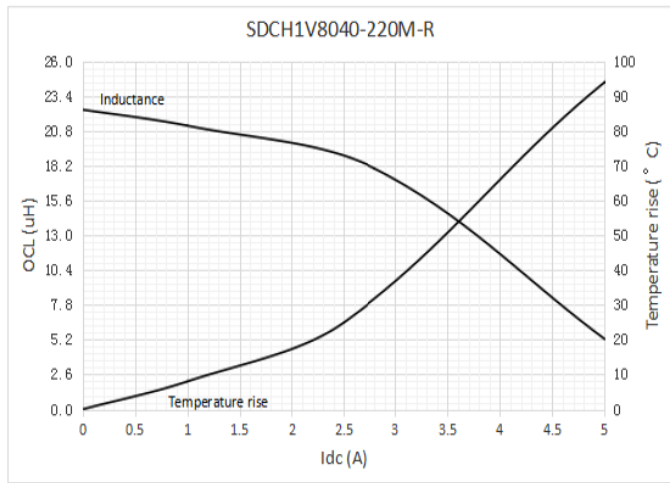
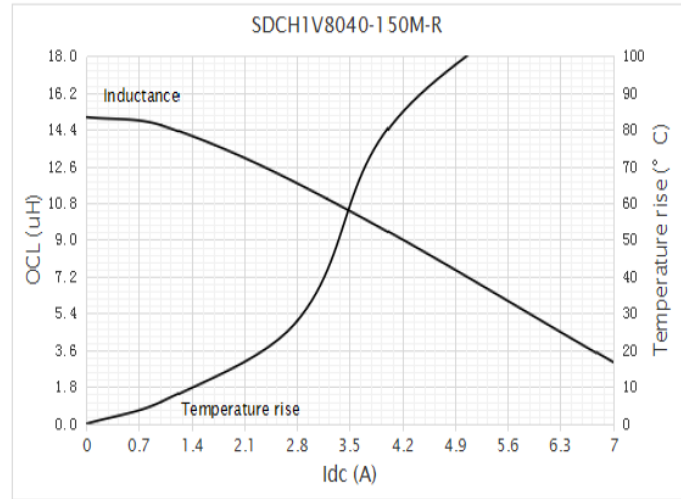
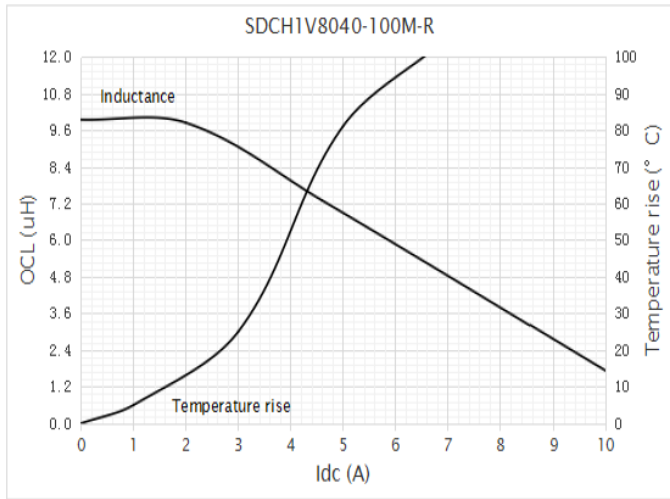

Inductance and temperature rise vs current

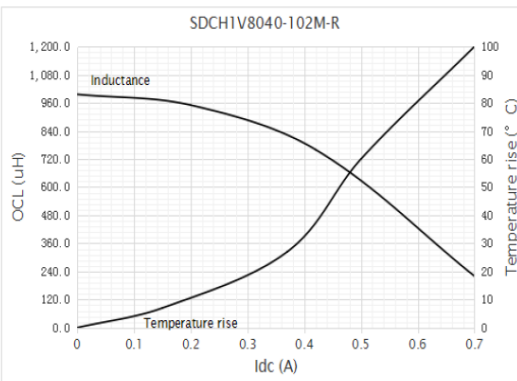
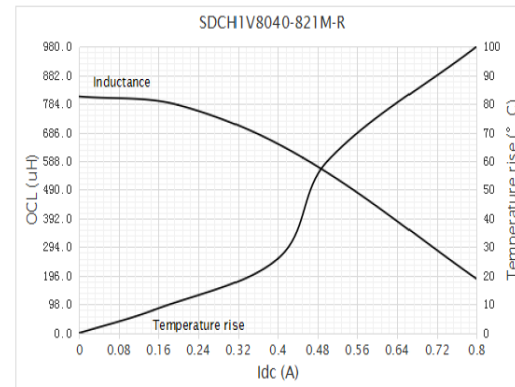
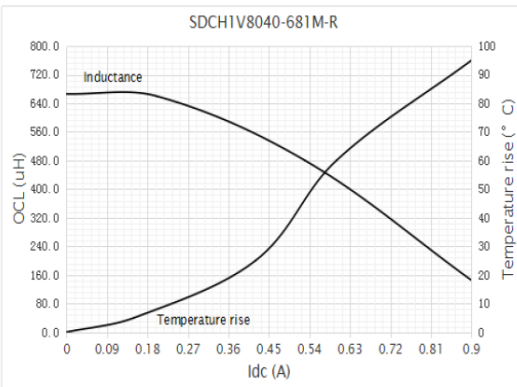
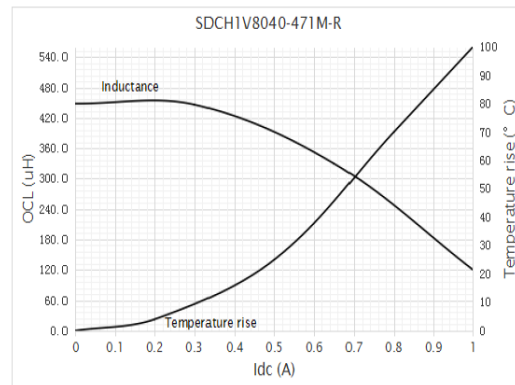
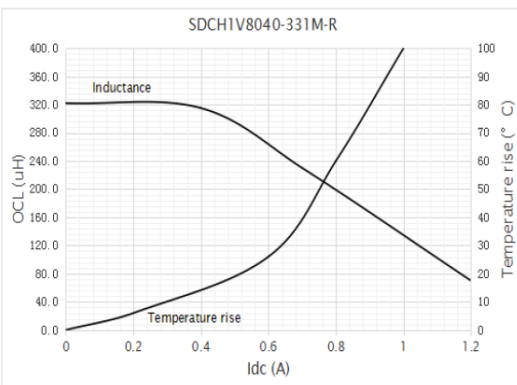
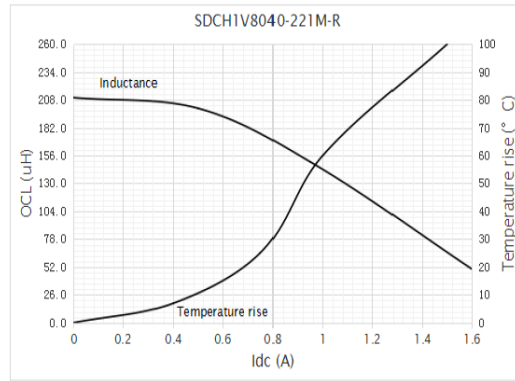
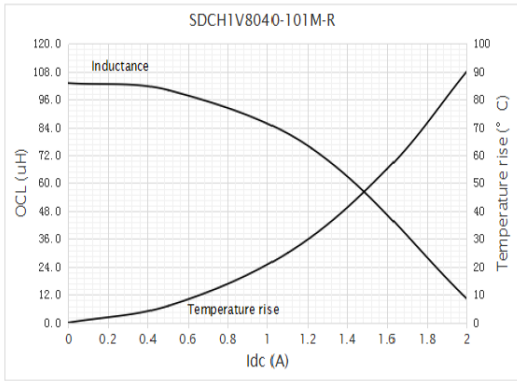

**Solder reflow profile**

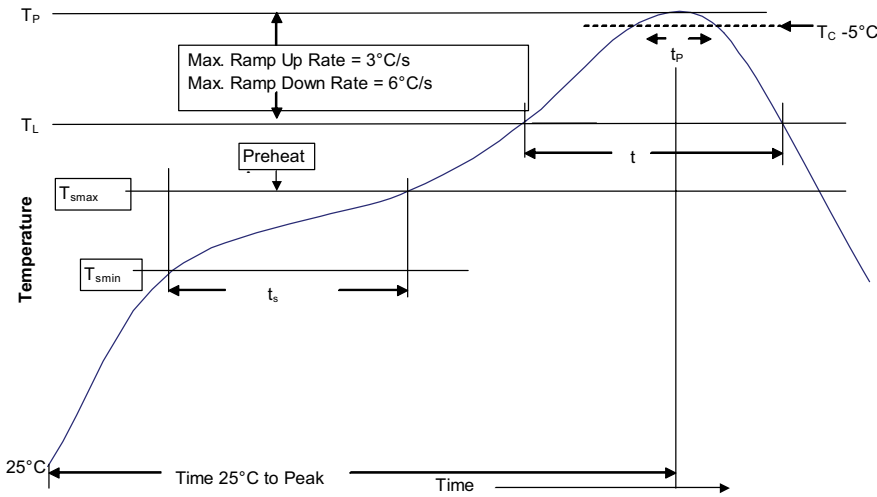

**Table 1 - Standard SnPb solder ( $T_C$ )**

Package thickness	Volume $\text{mm}^3$ <350	Volume $\text{mm}^3$ $\geq$ 350
<2.5 mm	235 °C	220 °C
$\geq$ 2.5 mm	220 °C	220 °C

**Table 2 - Lead (Pb) free solder ( $T_C$ )**

Package thickness	Volume $\text{mm}^3$ <350	Volume $\text{mm}^3$ 350 - 2000	Volume $\text{mm}^3$ >2000
<1.6 mm	260 °C	260 °C	260 °C
1.6 – 2.5 mm	260 °C	250 °C	245 °C
>2.5 mm	250 °C	245 °C	245 °C

**Reference J-STD-020**

Profile feature	Standard SnPb solder	Lead (Pb) free solder
Preheat and soak		
• Temperature min. ( $T_{smin}$ )	100 °C	150 °C
• Temperature max. ( $T_{smax}$ )	150 °C	200 °C
• Time ( $T_{smin}$ to $T_{smax}$ ) ( $t_s$ )	60-120 seconds	60-120 seconds
Ramp up rate $T_L$ to $T_p$	3 °C/ second max.	3 °C/ second max.
Liquidous temperature ( $T_L$ )	183 °C	217 °C
Time ( $t_L$ ) maintained above $T_L$	60-150 seconds	60-150 seconds
Peak package body temperature ( $T_p$ )*	Table 1	Table 2
Time ( $t_p$ )* within 5 °C of the specified classification temperature ( $T_C$ )	20 seconds*	30 seconds*
Ramp-down rate ( $T_p$ to $T_L$ )	6 °C/ second max.	6 °C/ second max.
Time 25 °C to peak temperature	6 minutes max.	8 minutes max.

\* Tolerance for peak profile temperature ( $T_p$ ) is defined as a supplier minimum and a user maximum.

Life Support Policy: Eaton does not authorize the use of any of its products for use in life support devices or systems without the express written approval of an officer of the Company. Life support systems are devices which support or sustain life, and whose failure to perform, when properly used in accordance with instructions for use provided in the labeling, can be reasonably expected to result in significant injury to the user.

Eaton reserves the right, without notice, to change design or construction of any products and to discontinue or limit distribution of any products. Eaton also reserves the right to change or update, without notice, any technical information contained in this bulletin.

**Eaton**  
Electronics Division  
1000 Eaton Boulevard  
Cleveland, OH 44122  
United States  
Eaton.com/electronics

© 2021 Eaton  
All Rights Reserved  
Printed in USA  
Publication No. ELX1035 BU-ELX21035  
April 2021

Eaton is a registered trademark.  
All other trademarks are property of their respective owners.

Follow us on social media to get the latest product and support information.

