

**Mounting Option**

02-.128 (3.25) Dia. Mounting Holes

0.370 [9.40]  
Card Slot Accepts  
.054 [1.37] to .070 [1.78]  
Thick P.C. Board

**Contact Detail**

542-Wire Wrap .025 Sq.(0.64 Sq.) - Tail LG=.645(16.38)  
.156 [3.96] Contact Spacing x .200 [5.08] Row Spacing

THIS IS A C.A.D. GENERATED DRAWING  
DO NOT MAKE MANUAL REVISIONS TO MASTER.



ISSUE NUMBER

ORIGINAL ①

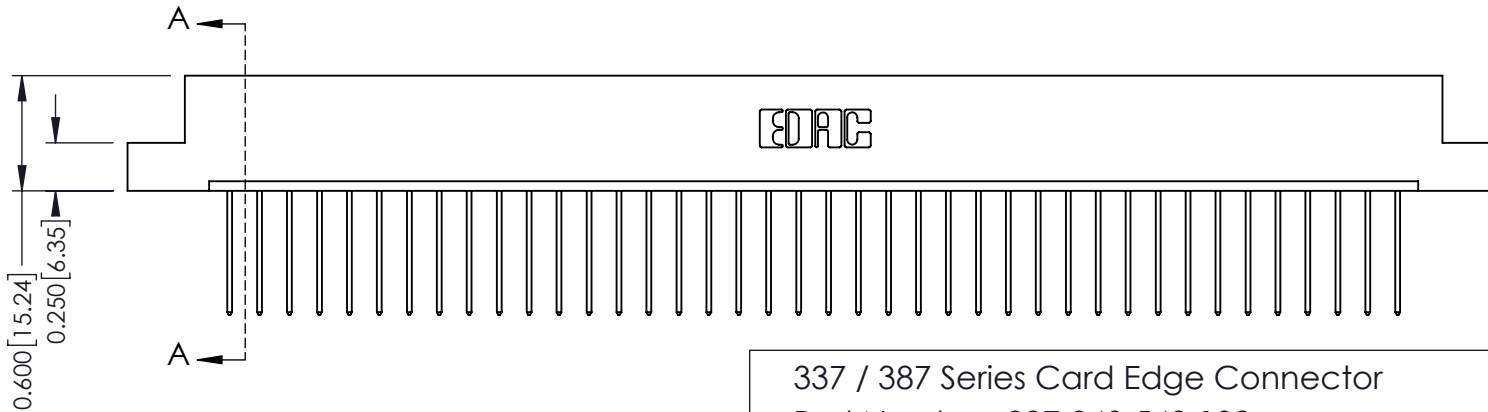
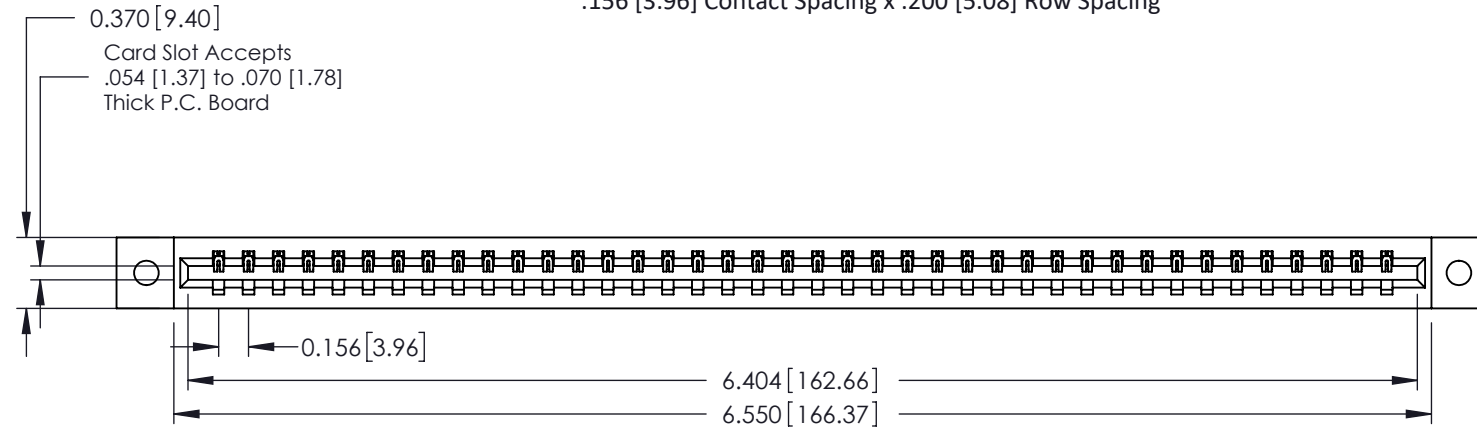

See Accompanying Pages for:

- Contact Bend Details
- Mounting Options

337 / 387 Series Card Edge Connector  
Part Number: 337-040-542-102



YOUR CONNECTION TO QUALITY & SERVICE

EDAC INC  
TORONTO, ONTARIO  
CANADA

THESE DRAWINGS AND SPECIFICATIONS  
ARE THE PROPERTY OF EDAC INC. AND  
SHALL NOT BE REPRODUCED, OR COPIED  
OR USED AS THE BASIS FOR THE  
MANUFACTURE OR SALE OF APPARATUS  
WITHOUT WRITTEN PERMISSION.

ACAD REFERENCE NO. 337 ENG MASTER	
DRAWN: J.LEE	DATE: OCT. 06/09
CHECKED:	DATE:
SCALE: NTS	SHEET 1 OF 3
DRAWING NUMBER 337 Assembly	ISSUE 1

THIS IS A C.A.D. GENERATED DRAWING  
DO NOT MAKE MANUAL REVISIONS TO MASTER.



ISSUE NUMBER	
ORIGINAL	①



555 Contact Code



556 Contact Code



558 Contact Code



559 Contact Code



560 Contact Code

### 337 / 387 Series Card Edge Connector Contact Bend Detail



EDAC INC  
TORONTO, ONTARIO  
CANADA

YOUR CONNECTION TO QUALITY & SERVICE

THESE DRAWINGS AND SPECIFICATIONS  
ARE THE PROPERTY OF EDAC INC. AND  
SHALL NOT BE REPRODUCED, OR COPIED  
OR USED AS THE BASIS FOR THE  
MANUFACTURE OR SALE OF APPARATUS  
WITHOUT WRITTEN PERMISSION.

ACAD REFERENCE NO. 337 ENG MASTER	
DRAWN: J.LEE	DATE: OCT. 06/09
CHECKED:	DATE:
SCALE: NTS	SHEET 2 OF 3
DRAWING NUMBER 337 Assembly	ISSUE 1

THIS IS A C.A.D. GENERATED DRAWING  
DO NOT MAKE MANUAL REVISIONS TO MASTER.



ISSUE NUMBER  
ORIGINAL ①



### 337 / 387 Series Card Edge Connector Mounting Options



YOUR CONNECTION TO QUALITY & SERVICE

EDAC INC  
TORONTO, ONTARIO  
CANADA

THESE DRAWINGS AND SPECIFICATIONS  
ARE THE PROPERTY OF EDAC INC. AND  
SHALL NOT BE REPRODUCED, OR COPIED  
OR USED AS THE BASIS FOR THE  
MANUFACTURE OR SALE OF APPARATUS  
WITHOUT WRITTEN PERMISSION.

ACAD REFERENCE NO. 337 ENG MASTER

DRAWN: J.LEE DATE: OCT. 06/09

CHECKED: DATE:

SCALE: NTS SHEET 3 OF 3

DRAWING NUMBER 337 Assembly ISSUE 1