

Description

Single pole compact high performance thermal circuit breaker with tease-free, trip-free, snap action mechanism and push/pull on/off manual actuation (M-type TO CBE to EN 60934). An indicator band on the push button clearly shows the tripped/off position. Threadneck panel mounted in tracked vehicle and aircraft/general purpose versions, with optional auxiliary contacts.

Typical applications

Extra low voltage wiring systems on all types of vehicles for land, sea and air, battery powered machines, process control.

Ordering information

Type No.	482	single pole thermal circuit breaker
Mounting	G	threadneck panel mounting
Threadneck design	1	M 12x1 nickel plated
	2	M 12x1 black
Hardware - washer for threadneck	0	without hardware
	1	corrugated washer 12/15, fitted
Hardware - hex nut for threadneck	0	without hardware
	1	hex nut M12x1 nickel plated
	2	hex nut M12x1 black
Terminal design (main terminals)	K1	screw terminals with metric thread M4
Characteristic curve	M1	thermal 1.15-1.4 I _N
Terminal screws	A	flat head screw M4x6, ISO 1580, fitted
	F	Phillips screw M4x6 (ISO 7045), bulk shipped
	Z	without
Terminal washers	0	without lock washer
	1	lock washer DIN 137-B4, fitted
	6	lock washer DIN 137-B4, bulk shipped
Auxiliary contact	S0	without auxiliary contacts
	S1	with auxiliary contact (NC)
Current ratings	0.1...50 A	

482 - G 1 1 1 - K1 M1 - A 1 S1 - 10 A ordering example

Please be informed that we have minimum ordering quantities to be observed.

Preferred types

Preferred types	Standard current ratings (A)												
	1	3	5	6	8	10	15	20	25	30	35	40	50
482-G111-K1M1-A1S0-	x	x	x	x	x	x	x	x	x	x	x	x	x
482-G212-K1M1-A1S0-	x		x			x	x	x	x	x	x	x	x

Approvals

Authority	Standard	Rated voltage	Current ratings
UL	UL 1077	DC 72 V	0.1 A...50 A
CSA	C22.2 No 235	DC 72 V	0.1 A...50 A
Bw	VG 95345, part 21	DC 28 V	0.5 A...50 A

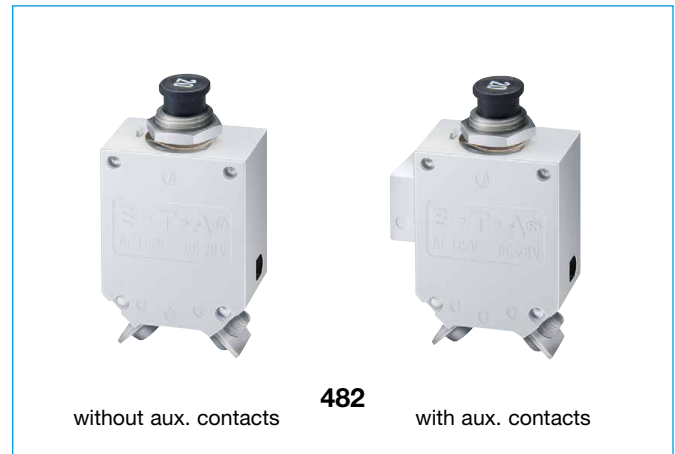

Technical data

For further details please see: www.e-t-a.de/ti_e

Voltage rating	AC 115 V (400 Hz); DC 28 V AC 230 (50/60 Hz) to special order	
Current rating range	0.1...50 A	
Auxiliary circuit	0.5 A, DC 28 V	
Typical life	10,000 operations mechanical 5,000 operations at I _N	
Ambient temperature	-55...+75 °C (-67...+167 °F)	
Insulation co-ordination (IEC 60664 and 60664A)	rated impulse withstand voltage 1.5 kV	pollution degree 3
Dielectric strength (IEC 60664 and 60664A)	test voltage operating area main to aux. circuit	AC 1,500 V AC 1,500 V
Insulation resistance	> 100 MΩ (DC 500 V)	
Interrupting capacity I _{cn}	0.1...2.5 A 3...3.5 A 4...7 A 7.5...50 A 35...50 A	15 x I _N 250 A DC / 150 A AC 500 A 6,000 A DC / 1,000 A AC with auxiliary contact: 3,000 A DC / 1,000 A AC
Interrupting capacity (UL 1077)	I _N 0.1...50 A	U _N DC 72 V, 5,000 A
Degree of protection (IEC 60529/DIN 40050)	operating area IP40 terminal area IP00	
Vibration	10 g (55-2000 Hz), ± 0.76 mm (10-55 Hz) to VG 95210, sheet 19/IEC 60068-2-6, test Fc	
Shock	50 g (11 ms) to VG 95210, sheet 28/IEC 60068-2-27, test Ea	
Corrosion	48 hours at 5 % salt mist to VG 95210, sheet 2/IEC 60068-2-11, test Ka	
Humidity	240 hours at 95 % RH to VG 95210, sheet 7/IEC 60068-2-3, test C	
Explosion	to VG 95210, sheet 10/MIL-STD-202, meth. 109	
Mass	approx. 43 g without auxiliary contact approx. 46 g with auxiliary contact	

Previous ordering codes:
 482-N-MS = 482-G111-K1M1-A1S0-...A
 482-MS = 482-G212-K1M1-A1S0-...A

Standard current ratings and typical volt drop values

Current rating (A)	Volt drop (mV)	Current rating (A)	Volt drop (mV)
0.1	16,000	5	350
0.2	8,000	7.5	230
0.5	3,000	10	< 200
0.8	2,000	15	< 200
1	1,500	20	< 200
1.2	1,200	25	< 200
1.5	1,000	30	< 200
1.8	850	35	< 200
2	800	40	< 200
2.5	700	45	< 200
3	600	50	< 200
4	430		

Dimensions 482-G1...

482-G111-K1M1-A1S0 (VG 95345 T21)



482-G111-K1M1-A1S1 (VG 95345 T21)

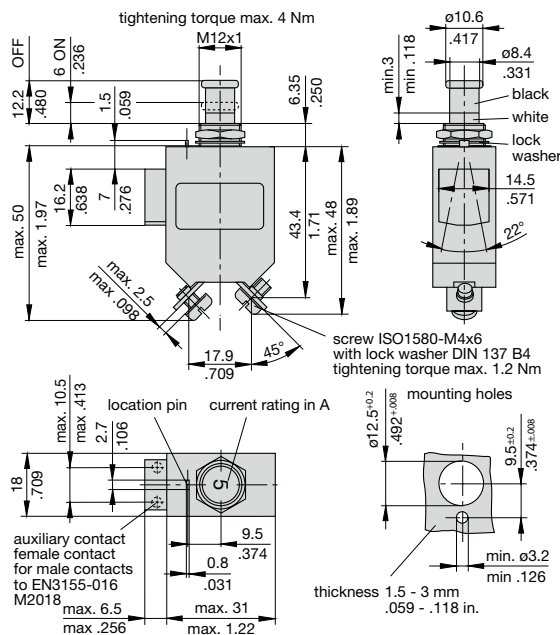

Dimensions 482-G2../-G6../-G7...

482-G212-K1M1-A1S0 (VG 95345 T21)



Internal connection diagrams

with auxiliary contact

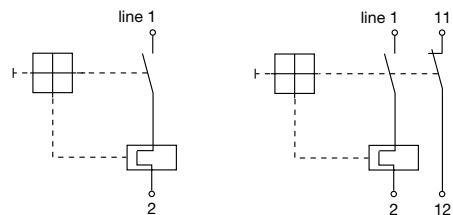

This is a metric design and millimeter dimensions take precedence ($\frac{\text{mm}}{\text{inch}}$)

Typical time/current characteristics

0.1...2.5 A

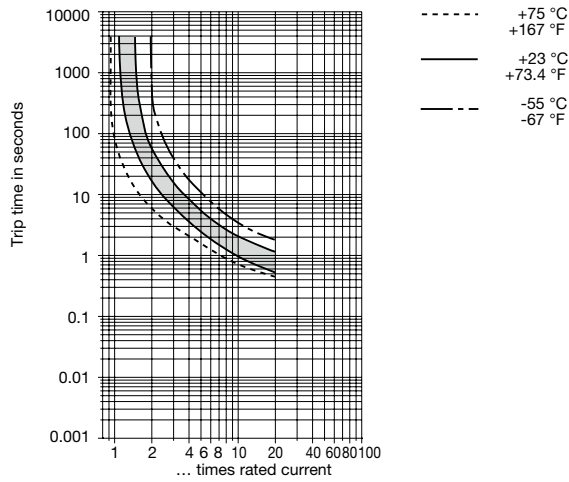

3...50 A

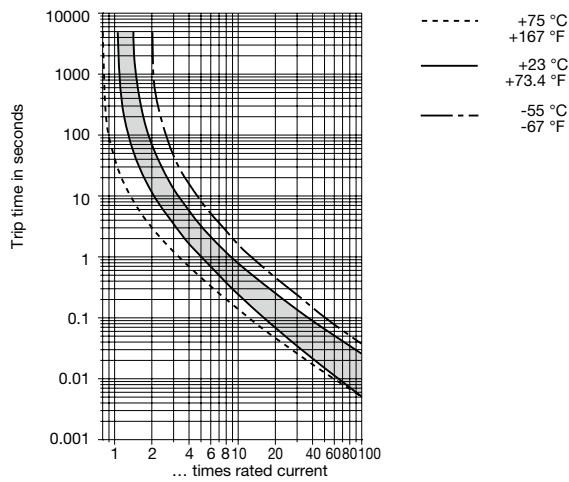

Accessories (approved to VG 95345, part 23)

- Splash cover /hex nut assembly with O ring (IP66 and IP67)**
X 200 801 08 nickel plated nut M12x1, transparent cover
X 200 801 03 matt black finish nut M12x1, black cover
X 200 801 12 with blackened nut and transparent cover



- Splash cover black /hex nut assembly with O ring (IP54)**
X 200 802 01 nickel plated nut M12x1
X 200 802 02 matt black finish nut M12x1



- Actuator extension (black)**
 to be fitted on the push button
X 200 803 01



Accessories

- Identification collar to be snapped on the push button**

- Y 307 004 01** black
- Y 307 004 02** white
- Y 307 004 03** red
- Y 307 004 04** green
- Y 307 004 05** blue

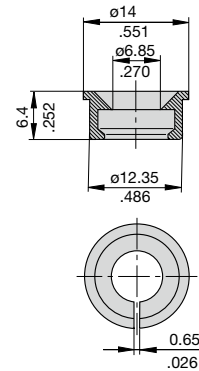

- Lock out ring to block the push button in OFF position**
Y 307 005 01 red
Y 307 005 02 black

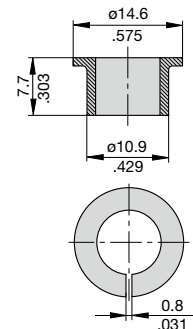

This is a metric design and millimeter dimensions take precedence ($\frac{\text{mm}}{\text{inch}}$)

All dimensions without tolerances are for reference only. In the interest of improved design, performance and cost effectiveness the right to make changes in these specifications without notice is reserved. Product markings may not be exactly as the ordering codes. Errors and omissions excepted.

