

## STRADA-SQ-T3B

IESNA Type III (medium) beam with minimized backlight. Version with location pins. Assembly with installation tape.

### SPECIFICATION:

Dimensions	25.0 x 25.0 mm
Height	8.4 mm
Fastening	tape
ROHS compliant	yes ⓘ



### MATERIALS:

Component	Type	Material	Colour	Finish
STRADA-SQ-T3B	Single lens	PMMA	clear	
ROSE-TAPE	Tape	Acrylic foam	black	

### ORDERING INFORMATION:

Component	Type	Qty in box	MOQ	MPQ	Box weight (kg)
CA14949_STRADA-SQ-T3B » Box size: 476 x 273 x 292 mm	Single lens	2058	294	98	7.8

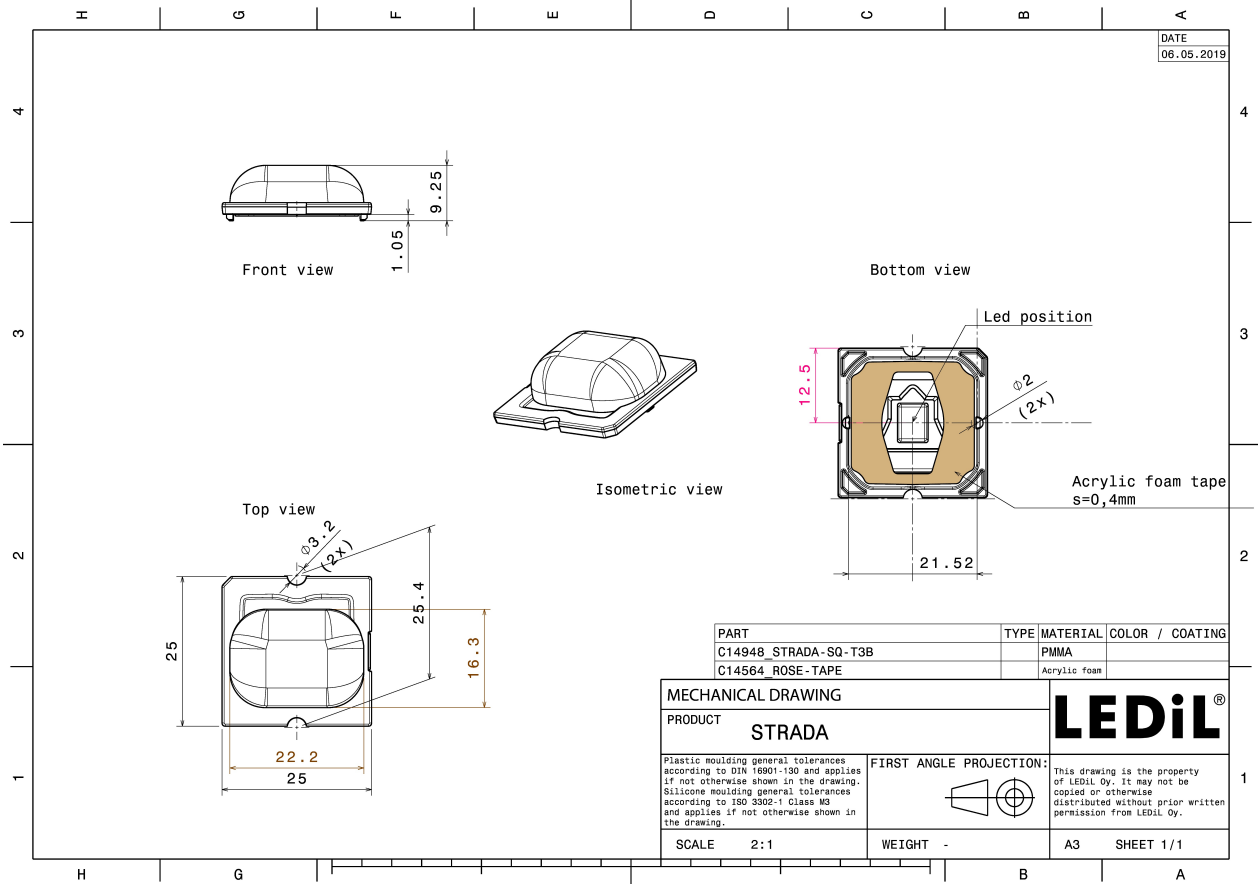

See also our general installation guide: [www.ledil.com/installation\\_guide](http://www.ledil.com/installation_guide)

#### OPTICAL RESULTS (MEASURED):

##### CREE LED

LED MK-R  
FWHM / FWTM Asymmetric  
Efficiency 92 %  
Peak intensity 0.5 cd/lm  
LEDs/each optic 1  
Light colour White  
Required components:

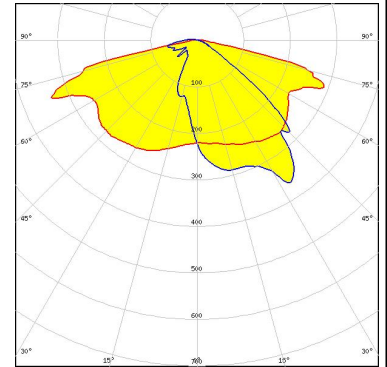

##### CREE LED

LED XHP50  
FWHM / FWTM Asymmetric  
Efficiency 94 %  
Peak intensity 0.7 cd/lm  
LEDs/each optic 1  
Light colour White  
Required components:

##### LUMILEDS

LED LUXEON M/MX  
FWHM / FWTM Asymmetric  
Efficiency 92 %  
Peak intensity 0.5 cd/lm  
LEDs/each optic 1  
Light colour White  
Required components:

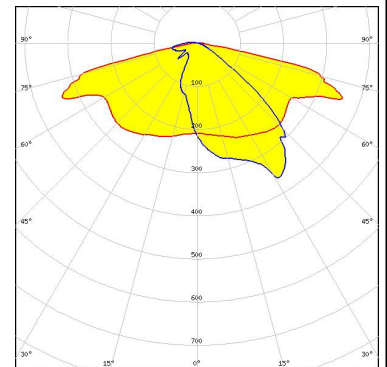

##### LUMILEDS

LED LUXEON MZ  
FWHM / FWTM Asymmetric  
Efficiency 91 %  
Peak intensity 0.8 cd/lm  
LEDs/each optic 1  
Light colour White  
Required components:

#### OPTICAL RESULTS (MEASURED):

		
LED	NVSW319B	
FWHM / FWTM	Asymmetric	
Efficiency	94 %	
Peak intensity	0.7 cd/lm	
LEDs/each optic	1	
Light colour	White	
Required components:		
		
		
LED	Duris S8	
FWHM / FWTM	Asymmetric	
Efficiency	94 %	
Peak intensity	0.6 cd/lm	
LEDs/each optic	1	
Light colour	White	
Required components:		
		

#### OPTICAL RESULTS (SIMULATED):

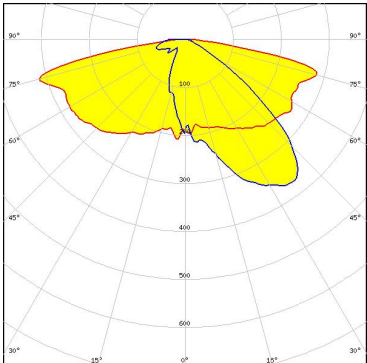
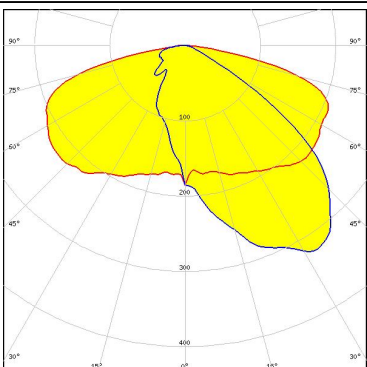
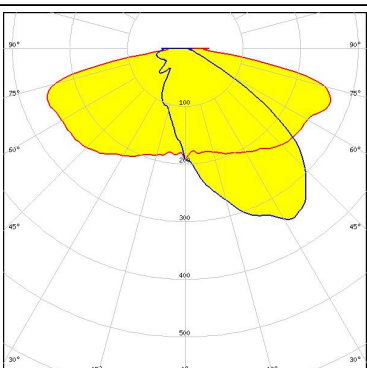
<p><b>CREE</b> ⇄ <b>LED</b></p> <p>LED: MHB-A/B            FWHM / FWTM: Asymmetric            Efficiency: 93 %            Peak intensity: 0.4 cd/lm            LEDs/each optic: 1            Light colour: White            Required components:</p>	
<p><b>CREE</b> ⇄ <b>LED</b></p> <p>LED: MHB-A/B            FWHM / FWTM: Asymmetric            Efficiency: %            LEDs/each optic: 1            Light colour: White            Required components:</p>	
<p><b>CREE</b> ⇄ <b>LED</b></p> <p>LED: XHP70.2            FWHM / FWTM: Asymmetric            Efficiency: 76 %            Peak intensity: 0.3 cd/lm            LEDs/each optic: 1            Light colour: White            Required components:</p> <p style="background-color: #e0f0ff; padding: 2px; display: inline-block;">Protective plate, glass</p>	
<p><b>CREE</b> ⇄ <b>LED</b></p> <p>LED: XHP70.2            FWHM / FWTM: Asymmetric            Efficiency: 91 %            Peak intensity: 0.4 cd/lm            LEDs/each optic: 1            Light colour: White            Required components:</p>	

#### OPTICAL RESULTS (SIMULATED):

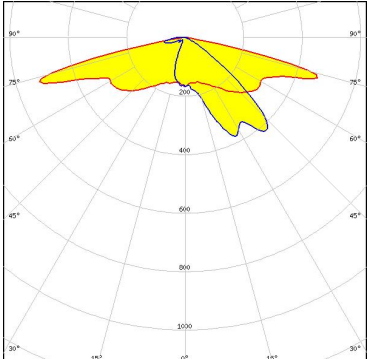
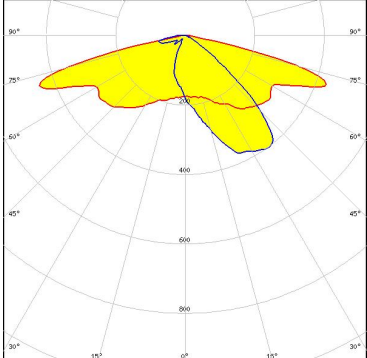
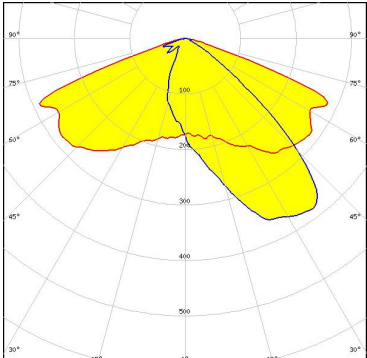
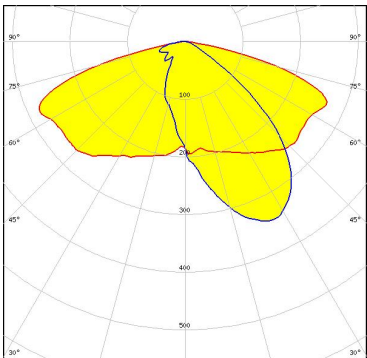
<p><b>CREE LED</b></p> <p>LED XM-L2            FWHM / FWTM Asymmetric            Efficiency 94 %            Peak intensity 0.6 cd/lm            LEDs/each optic 1            Light colour White            Required components:</p>	
<p><b>LUMILEDS</b></p> <p>LED LUXEON 5050 Round LES            FWHM / FWTM Asymmetric            Efficiency 94 %            Peak intensity 0.6 cd/lm            LEDs/each optic 1            Light colour White            Required components:</p>	
<p><b>LUMILEDS</b></p> <p>LED LUXEON 5050 Round LES            FWHM / FWTM Asymmetric            Efficiency 78 %            Peak intensity 0.5 cd/lm            LEDs/each optic 1            Light colour White            Required components:</p> <p>Protective plate, glass</p>	
<p><b>LUMILEDS</b></p> <p>LED LUXEON 7070            FWHM / FWTM Asymmetric            Efficiency 81 %            Peak intensity 0.4 cd/lm            LEDs/each optic 1            Light colour White            Required components:</p> <p>Protective plate, glass</p>	

#### OPTICAL RESULTS (SIMULATED):

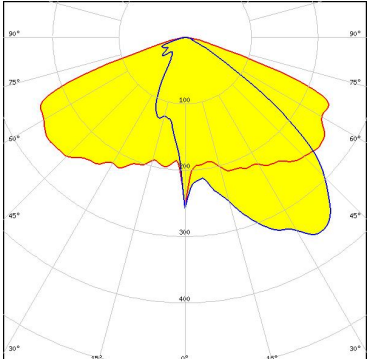
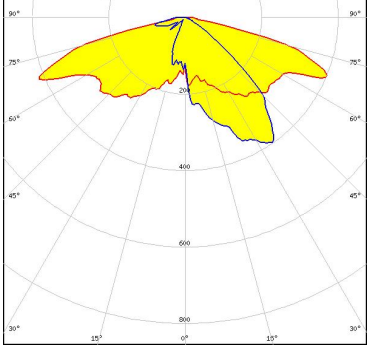
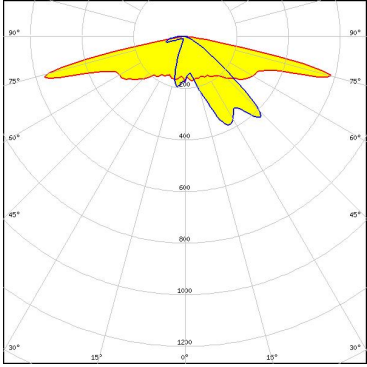
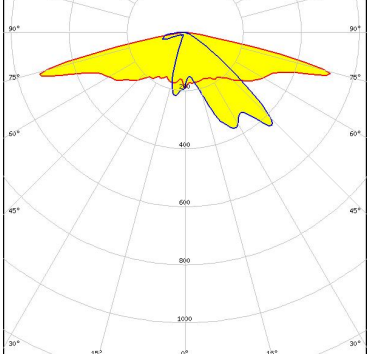
<p><b>LUMILEDS</b></p> <p>LED LUXEON M/MX            FWHM / FWTM Asymmetric            Efficiency 77 %            Peak intensity 0.4 cd/lm            LEDs/each optic 1            Light colour White            Required components:</p> <p>Protective plate, glass</p>	
<p><b>OSRAM</b>  <small>Opto Semiconductors</small></p> <p>LED OSCONIQ P 7070            FWHM / FWTM Asymmetric            Efficiency 92 %            Peak intensity 0.6 cd/lm            LEDs/each optic 1            Light colour White            Required components:</p>	
<p><b>OSRAM</b>  <small>Opto Semiconductors</small></p> <p>LED OSOLON Square CSSRM2/CSSRM3            FWHM / FWTM Asymmetric            Efficiency 94 %            Peak intensity 0.6 cd/lm            LEDs/each optic 1            Light colour White            Required components:</p>	
<p><b>OSRAM</b>  <small>Opto Semiconductors</small></p> <p>LED OSOLON Square EC            FWHM / FWTM Asymmetric            Efficiency 93 %            Peak intensity 0.6 cd/lm            LEDs/each optic 1            Light colour White            Required components:</p>	

#### GENERAL INFORMATION:

NOTE: The typical beam angle will be changed by different color, chip size and chip position tolerance. The typical total beam angle is the full angle measured where the luminous intensity is half of the peak value.

#### MATERIALS:

As part of our continuous research and improvement processes, and to ensure the best possible quality and availability of our products, LEDiL reserves the right to change material grades without notice.

#### PRODUCT DATA USER AGREEMENT AND DISCLAIMER:

The measured data in the provided downloadable LEDiL Product Datasheets and Mechanical 2D-Drawings is rounded and provided as reference for planning. LEDiL Oy's optical specifications have been verified by conducting performance testing of the products in accordance with the company's quality system. The reported data are averaged results of multiple measurements with typical variation. LEDiL Oy reserves the right to without prior notification make changes and improvements to its products.

LEDiL Oy assumes neither warranty, nor guarantee nor any other liability of any kind for the contents and correctness of the provided data. The provided data has been generated with highest diligence but the provided data may in reality not represent the complete possible variation range of all intrinsic parameters. Therefore, in certain cases a deviation from the provided data could occur.

LEDiL Oy reserves the right to undertake technical changes of its products without further notification which could lead to changes in the provided data. LEDiL Oy assumes no liability of any kind for the possible deviation from any provided data or any other damage resulting from the usage of the provided data.

The user agrees to this disclaimer and user agreement with the download or usage of the provided files.

#### LEDiL Oy

Joensuunkatu 13  
FI-24240 SALO  
Finland

#### LEDiL Inc.

228 West Page Street  
Suite D  
Sycamore IL 60178  
USA

#### Ledil Optics Technology (Shenzhen) Co., Ltd.

# 405 , Block B  
Casic Motor Building  
Shenzhen 518057  
P.R.CHINA

#### Local sales and technical support

[www.ledil.com/  
where\\_to\\_buy](http://www.ledil.com/where_to_buy)

#### Shipping locations

Salo, Finland  
Hong Kong, China

#### Distribution Partners

[www.ledil.com/  
where\\_to\\_buy](http://www.ledil.com/where_to_buy)