



SPECIFICATION SHEET

SPECIFICATION SHEET NO.	N0830- CA42A035M226BA
DATE	Aug. 30, 2021
REVISION	A0
DESCRIPTION	<p>Dip Type Epoxy-Coated Solid Electrolytic Tantalum Capacitor CA42 Series, Case A, Lead Space 2.54mm (0.100") Rated voltage 35 Vdc, Capacitance 22μF, Tolerance ±20% Operating Temp. Range -55°C ~+125°C, Package in Bulk, 1000pcs/polybag and inner box RoHS/RoHS III compliant</p>
CUSTOMER	
CUSTOMER PART NUMBER	
CROSS REF. PART NUMBER	
ORIGINAL PART NUMBER	CA42-35V22
PART CODE	CA42A035M226BA

VENDOR APPROVE			
Issued/Checked/Approved			
DATE: Aug. 30, 2021			

CUSTOMER APPROVE	
DATE:	

DIP TANTALUM CAPACITORS CA42 SERIES CASE A

MAIN FEATURE

- RoHS III Compliant
- Wide Operating Temperature Range -55~+125°C
- Epoxy-coated and Radial- lead
- Stable in electrical & storage performances

APPLICATION

- For TV sets, PC, Mobile Telephone sets Pickup camera Radar etc.
- Instruments, Meters and more electronical equipment.

RFQ
Request For Quotation

PART CODE GUIDE

CA42	A	035	M	226	B	A
1	2	3	4	5	6	7

- 1) **CA42**: Series code for Dip Type Epoxy-Coated Solid Electrolytic Tantalum Capacitors
- 2) **A**: Case size code for Lead space , A: 2.54mm(0.100"); B: 5.08mm (0.200")
- 3) **035**: Rated voltage Code, 035: 35Vdc
- 4) **M**: Capacitance Tolerance code, K: +/-10%; M: +/-20%
- 5) **226**: Capacitance Code: 1st two digits represent Significant figures, 3rd Digit specifies number of Zeros. 226: 22μF
- 6) **B**: Package code, B: in Bulk, 1000pcs/polybag; A: In Paper Tape AMMO
- 7) **A**: Internal control or Customer's Special Code (A~Z or 1~9)

CROSS REFERENCE LIST for reference

Our Series Code	Other Brand Manufacturer	Cross Product series
CA42	AVX	TAP
	Kemet	T350~T356
	NEC	ND, NP
	NIC	NDTM
	NICHICON	S89
	NEMCO/SUNTSU	TB
	PANASONIC	ECSF
	VISHAY	199D, 489D, ETPW, ETQW

DIP TANTALUM CAPACITORS CA42 SERIES CASE A

MORE ITEMS AVAILABLE

CA42A010M106BA	CA42A010M226BA	CA42A010M476BA	CA42A016M106BA	CA42A016M107BA
CA42A016M156BA	CA42A016M225BA	CA42A016M226BA	CA42A016M335BA	CA42A016M336BA
CA42A016M475BA	CA42A016M476BA	CA42A020M106BA	CA42A025M105BA	CA42A025M106BA
CA42A025M156BA	CA42A025M225BA	CA42A025M226BA	CA42A025M335BA	CA42A025M336BA
CA42A025M475BA	CA42A025M476BA	CA42A025M685BA	CA42A035M104BA	CA42A035M154BA
CA42A035M224BA	CA42A035M474BA	CA42A035M684BA	CA42A035M105BA	CA42A035M106BA
CA42A035M226BA	CA42A035M335BA	CA42A035M475BA	CA42A004M687BA	CA42A050M334BA
CA42A050M684BA	CA42A050M105BA	CA42A050M335BA	CA42A6R3M476BA	

PRODUCT STRUCTURE for reference

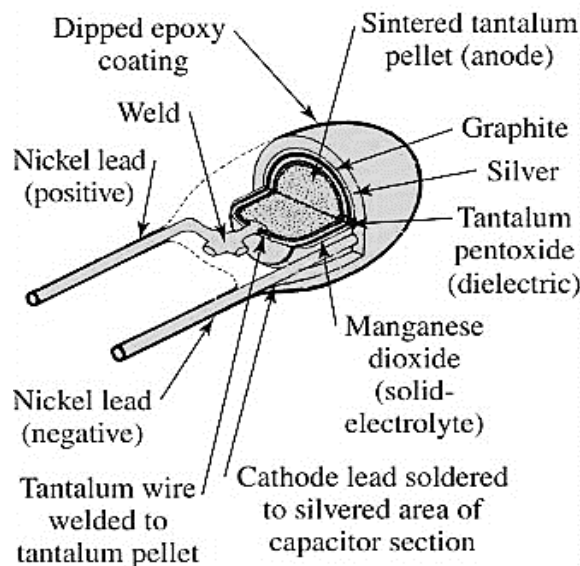

DIP TANTALUM CAPACITORS CA42 SERIES CASE A

DIMENSION (Unit: mm)



Image for reference



CA42 Case A

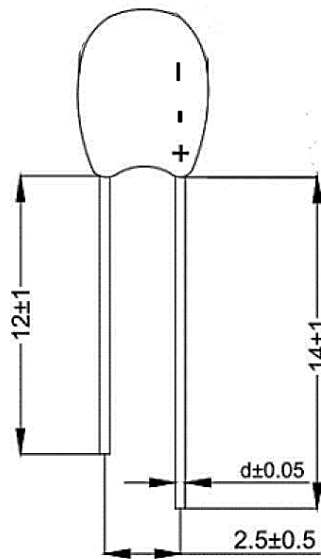

Item	Dimension
d	0.5±0.5mm

Marking: 226/35

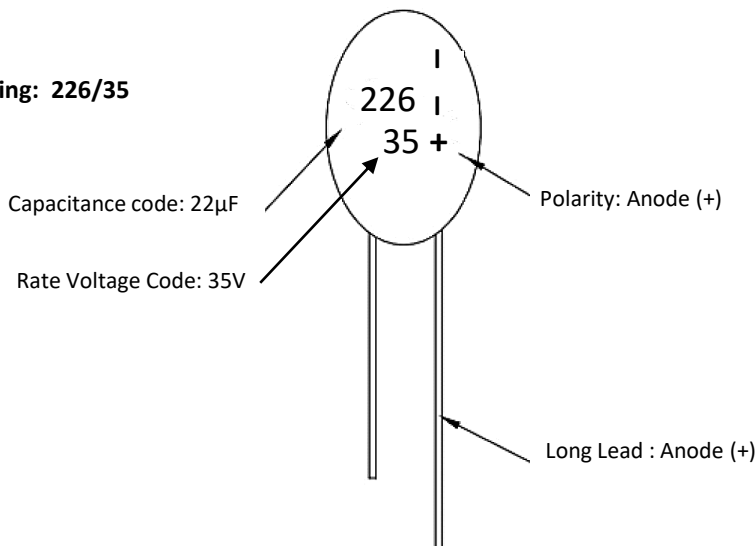

DIP TANTALUM CAPACITORS CA42 SERIES CASE A
ELECTRONICAL CHARACTERISTICS

Item	Unit	Symbol	Characteristic	Condition
Operating Temperature Range	°C		-55~+125	@ > 85°C Applying Voltage Derating: 10V
Rated Voltage Range	V DC		35	
Capacitance Tolerance	%		±20	@25°C, 100Hz, V: 0.3+/0.02
Leakage Current	µA	I ₀	Measured after 1 Minutes Application of rated voltage reading, I ₀ ≤ 0.02 CRUR or 1.0µA Max. whichever is greater @25 °C	CR: (µF) Nominal Capacitance UR: (V) Rated voltage
Capacitance	µF	C _R	22	@25°C, 100Hz
Dissipation Factor	%	tgδ	8.0 Max.	@25°C, 100Hz, V: 0.3+/0.02

TEMPERATURE CHARACTERISTICS

Item	Unit	Capacitance change			Dissipation Factor (Max)				Leakage Current (I Max.)		
Temperature Characteristics		@Nominal Capacitance 22µF									
	°C	-55	+85	+125	-55	+20	+85	+125	+20	+85	+125
	%	±8	±12	±15							
	%				±8	±8	±10	±10			
	µA								I ₀ ≤ 0.002 CRUR or 1.0µA	10 I ₀	12.5 I ₀

DIP TANTALUM CAPACITORS CA42 SERIES CASE A

APPLICATION NTOE

Storage Condition

- 1) Environmental temperature: 10°C ~ +40°C
- 2) Relative humidity no more than 70%
- 3) Storing period: No more than one and half year since the date of stocking.

Application Guide

1) Ripple current and voltage

If the ripple current is applied to the capacitor, the Joule heat (power dissipated) will be generated in the capacitor, so it will affect the reliability of the capacitor.

(1) Power Dissipated

The actual power dissipated can be calculated using the following formula: $P=I^2 \times ESR$Formula 1

P: Power dissipated (W); I: Ripple current (A); ESR: Equivalent series resistance (Ω)

Power Dissipation for Case A 75mW Max. @+25°C

(2) Ripple current

Using the maximum power dissipation 65mW Max., the ripple current can be calculated using the following

formula: $I= \sqrt{\frac{P}{ESR}} \times K \times F$Formula 2

K: Temperature derating factor..... Table 1; F: Frequency derating factor..... Table 2

ESR: Refer to the ratings of each specific product

Table 1: Temperature Drop Factor K

Temperature	Temperature Derating Factor K
25 °C	1
85 °C	0.9
125 °C	0.4

Table 2: Frequency Derating Factor F

Frequency (KHz)	10	100	500	1000
MnO2	0.80	1.0	1.15	1.20

Using formula 3 to calculate corrugated voltage E: $E=Z \times I$ Formula 3

E: Ripple voltage; Z: Specific frequency impedance

DIP TANTALUM CAPACITORS CA42 SERIES CASE A

(3) Ripple voltage

The ripple voltage applied to the capacitor is limited by three criteria.

- (a) The power dissipation in the ESR of capacitor must not exceed 65mW Max. @+25°C
- (b) The positive peak AC voltage plus the DC bias voltage must not exceed the DC voltage rating of the capacitor.
- (c) The negative peak AC voltage, in combination with the bias voltage, if any, must not exceed the permissible reverse voltage ratings presented.

2) Reverse voltage

Solid tantalum capacitors are polarized devices, and applied reverse voltage can not be allowed. If the reverse voltage is unavoidable, a small degree of transient reverse voltage is permissible for short periods as follow.

25°C..... 10% of Max. rated voltage or 1V whichever is smaller

85°C..... 5% of Max. rated voltage or 0.5V whichever is smaller

125°C.....1% of Max. rated voltage or 0.1V whichever is smaller

Even under these restrictions, capacitors can not be used continuously in reverse voltage mode.

3) Working voltage

- (1) For general applications, using 50% of rated voltage of capacitors or less.
- (2) When used at the power circuit, low impedance circuit, coupling circuit or witching circuit which has leakage current problems, please design the circuit with voltage under 30% of the working voltage (Max. 50%) to avoid the adverse effect of the surge current.
- (3) Derating voltage when temperature above 85°C.

When the chip tantalum capacitor is used at 85°C or more temperatures, the reduced voltage (U_T) is calculated from the following expression, however, note that the ambient temperature is not more than 125°C.

$$U_T = V_0 (U_R - U_C)(T - 85) / 40$$

U_R : Rated voltage (V); U_C : Derating voltage at 125°C; T: Ambient temperature (°C)

DIP TANTALUM CAPACITORS CA42 SERIES CASE A

4) Protective resistance

In a circuit (switching circuit, charge / discharge circuit, etc.) that has an instantaneous current, series resistance is at least $3\Omega/V$, this can improve the reliability of tantalum capacitors. If the capacitor is in a low impedance circuit, the voltage applied to the capacitor should be half or one third of the rated voltage.

5) Redundancy

MnO₂ tantalum capacitors will heat, and may cause fire and burn in the short circuit. This is determined by the situation, time and other factors. When the circuit is designed, it is possible to provide the best possible space to keep the tantalum capacitor reliability.

6) Test Condition

Ambient Temperature 25°C; Relative Humidity 60 to 70%; Air Pressure 800 to 1060mbar. Test and experiment, in order to make the test results not problems, it is necessary to will test the product after fully discharge.

This product is a polar components, testing or when using it is strictly prohibited to will is negative pick back, in order to avoid performance failure

7) Soldering

The SMD tantalum capacitor can be used for reflow soldering, which is not suitable for wave soldering and manual welding. The reflow temperature are $\leq 260^{\circ}\text{C}$, ≤ 5 seconds. If you must use manual welding, should use the melted solder to contact lead, and the electric soldering iron power should be less than or equal to 25W, temperature should be less than 300°C , welding time should be less than 3 seconds, can not use electric iron contact the product lead directly, and in particular, can not contact the product ontology directly.

DIP TANTALUM CAPACITORS CA42 SERIES CASE A

8) Recommended Voltage Derating Guidelines

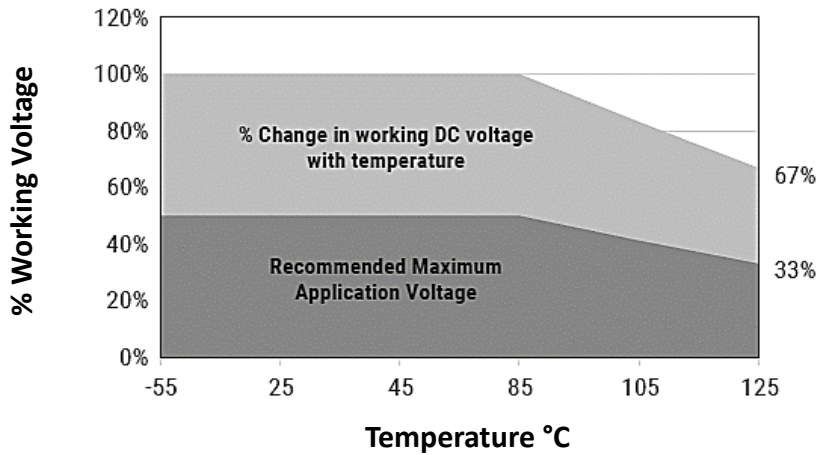

Condition	-55 °C ~ 85 °C	-55 °C ~ 125 °C
% Change in Working DC Voltage with Temperature	V _R	66% of V _R
Recommended Max. Application Voltage	50% of V _R	33% of V _R

PACKAGE

1000pcs are packed in polybag and inner box.

DISCLAIMER

NextGen Component, Inc. reserves the right to make changes to the product(s) and or information contained herein without notice. No liability is assumed as a result of their use or application. No rights under any patent accompany the sale of any such product(s) or information.