

**LTC3624**
**High Efficiency Synchronous  
 Step-Down Regulator with  
 Ultralow Quiescent Current**
**DESCRIPTION**

Demonstration circuit 2359A is a synchronous step-down regulator using **LTC<sup>®</sup>3624HMSE** monolithic buck regulator. The DC2359A operates from an input voltage range of 2.7V to 17V and provides an adjustable output voltage range from 1.2V to 5V ( $V_{OUT} < V_{IN}$ ) at 2A of continuous output current. A user-selectable mode input is provided with the following options: Burst Mode<sup>®</sup> operation provides the highest efficiency at light loads, while Pulse-Skipping mode (PS) provides the lowest output voltage ripples. Forced Continuous mode (FC) is also available for low EMI and noise interference.

The MODE/SYNC pin can also be used to synchronize the switching frequency to an external clock signal. The switching frequency is fixed at 1MHz with a  $\pm 40\%$  sync capture range.

The regulator features ultralow quiescent current and high efficiencies over a wide  $V_{IN}$  and  $V_{OUT}$  range. DC2359A

uses very low profile surface mount components and all ceramic output capacitor solutions. The compact 12-lead MSE (5mm  $\times$  4mm  $\times$  1mm) thermally enhanced package makes LTC3624HMSE an excellent choice for battery powered equipment, emergency radio and general purpose step-down power supplies. The H-Grade version is specified over an operating junction temperature range of  $-40^{\circ}\text{C}$  to  $150^{\circ}\text{C}$ , typically required for automotive, industrial and military applications that are subject to high ambient temperatures.

It is recommended to read the data sheet and demo manual of LTC3624 prior using or making any changes to DC2359A.

**Design files for this circuit board are available at <http://www.linear.com/demo/DC2359A>**

LT, LTC, LTM, Linear Technology, the Linear logo and Burst Mode are registered trademarks of Linear Technology Corporation. All other trademarks are the property of their respective owners.

**PERFORMANCE SUMMARY** Specifications are at  $T_A = 25^{\circ}\text{C}$ 

PARAMETER	CONDITIONS	VALUE
Input Voltage Range		2.7V to 17V
On Board User Selectable Output Voltages	$V_{IN} = 2.7\text{V to }17\text{V}$ , $I_{OUT} = 2\text{A}$ ( $V_{OUT} < V_{IN}$ )	1.2V, 1.8V, 2.5V, 3.3V and 5V
Default Mode Setting	JP2	Burst Mode ("BM" on Circuit Board)
Fixed Switching Frequency	Internally Programmed Frequency	1MHz $\pm 20\%$
Default Output Voltage $V_{OUT}$	$V_{IN} = 12\text{V}$ , $V_{OUT} = 5\text{V}$ , $I_{OUT} = 0\text{A to }2\text{A}$	5V $\pm 2\%$
Maximum Continuous Output Current $I_{OUT}$		2A
Output Voltage Ripples (Peak to Peak)	$V_{IN} = 12\text{V}$ , $V_{OUT} = 5\text{V}$ , $I_{OUT} = 2\text{A}$	8.8mV (Figure 7)
Load Transient Response	$V_{IN} = 12\text{V}$ , $V_{OUT} = 5\text{V}$ , $I_{OUT\_STEP} = 1\text{A to }2\text{A}$ , $C_{OUT} = 1 \times 47\mu\text{F}$	219mV (Figure 8)
Thermal Performance	$V_{IN} = 12\text{V}$ , $V_{OUT} = 5\text{V}$ , $I_{OUT} = 2\text{A}$ , $f_{SW} = 1\text{MHz}$ , $T_A = 25^{\circ}\text{C}$	Figure 9
Efficiency	$V_{IN} = 12\text{V}$ , $V_{OUT} = 5\text{V}$ , $I_{OUT} = 2\text{A}$ , BM, $f_{SW} = 1\text{MHz}$ , $T_A = 25^{\circ}\text{C}$	89.7% (Figure 3)

## QUICK START PROCEDURE

Demonstration circuit 2359A is easy to set up to evaluate the performance of the LTC3624HMSE. Please refer to Figure 1 for proper measurement equipment setup and follow the procedure below:

1. Place jumpers in the following positions for a typical 5V output application:

**Table 1. Typical 5V Output Voltage Jumper Selection**

JP1	JP2	JP7
RUN	MODE/SYNC	V <sub>OUT</sub>
ON	BM	5.0V

2. With power off, connect the input power supply at V<sub>IN</sub> (E1) and GND (E2)
3. Connect the Load between V<sub>OUT</sub> (E8) and GND (E9). Preset the load to 0A.
4. Connect the DMMs to the input and output to monitor the input voltage and output voltage.
5. Turn on the power supply at the input. The RUN pin jumper should be at "ON" position. Measure and make sure the input supply voltage is 12V. The output voltage should be 5V ±2%.
6. Once the input and output voltages are properly established, adjust the loads within the operating range (0A to 2A Max) and observe the output voltage regulation, output voltage ripple, switch node waveform and other parameters. Refer to Figure 2 for proper output voltage ripple measurement.

7. To select other output voltages, use the on board user selectable output voltage jumpers. Shutting down LTC3624HMSE by placing RUN pin jumper (JP1) to the OFF position or turn off the input power supply. Refer to the following table (Table 2) for the output voltage selection and repeat step 2 to 6.

**Table 2. Output Voltage Jumper Selection**

JP3	JP4	JP5	JP6	JP7	JP8*
1.2V	1.8V	2.5V	3.3V	5V	User Select

\*If JP8 is selected, R6 needs to be calculated and inserted to obtain the desired output voltage.

NOTE 1: To measure the input/output voltage ripple properly, do not use the long ground lead on the oscilloscope probe. See Figure 2 for the proper scope probe technique. Short, stiff leads need to be soldered to the (+) and (-) terminals of an output capacitor. The probe's ground ring needs to touch the (-) lead and the probe tip needs to touch the (+) lead.

NOTE 2: The DC2359A can also be used to evaluate the LTC3624HMSE-2 (2.25MHz) by simply replacing U1 with the LTC3624HMSE-2 and changing inductor L1 to 1.5µH (Coilcraft XAL4020-152ME).

**QUICK START PROCEDURE**

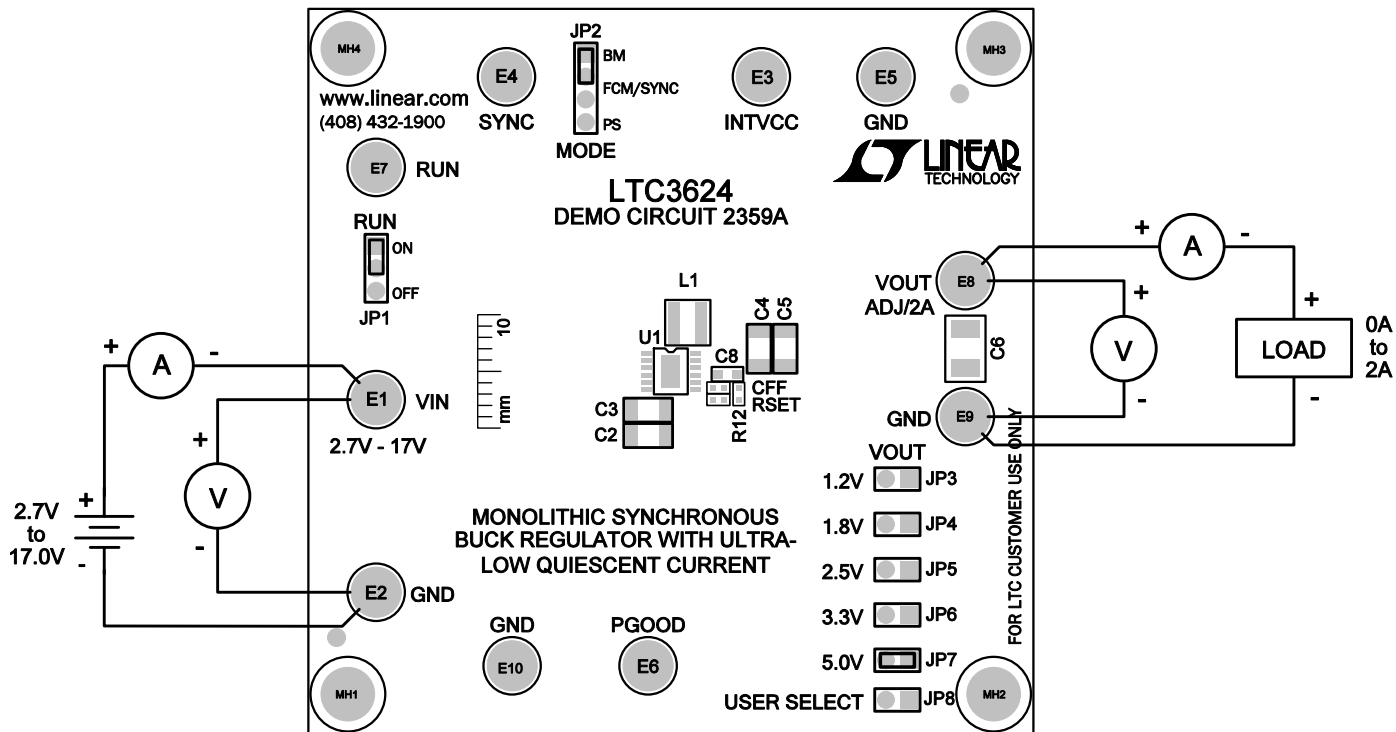

Figure 1. Proper Measurement Equipment Setup

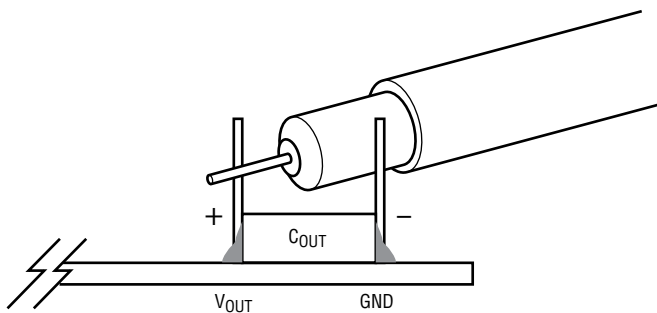

Figure 2. Scope Probe Placement for Measuring Output Voltage Ripple

## QUICK START PROCEDURE

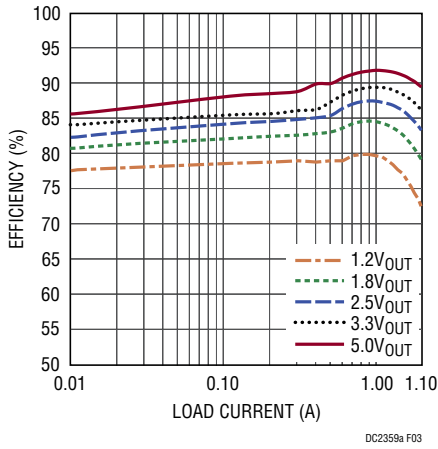

Figure 3. Burst Mode – Efficiency vs Load Current at 12VIN

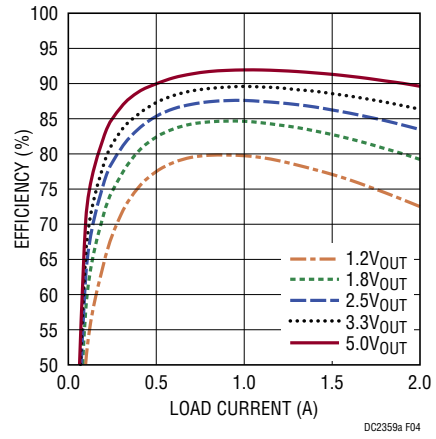

Figure 4. Forced Continuous Mode – Efficiency vs Load Current at 12VIN

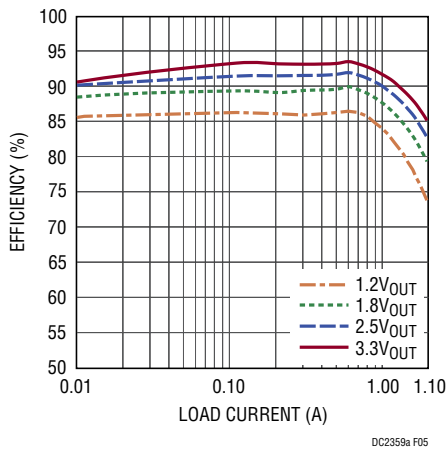

Figure 5. Burst Mode – Efficiency vs Load Current at 5VIN

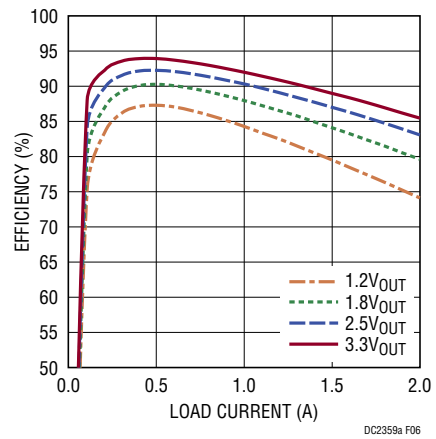
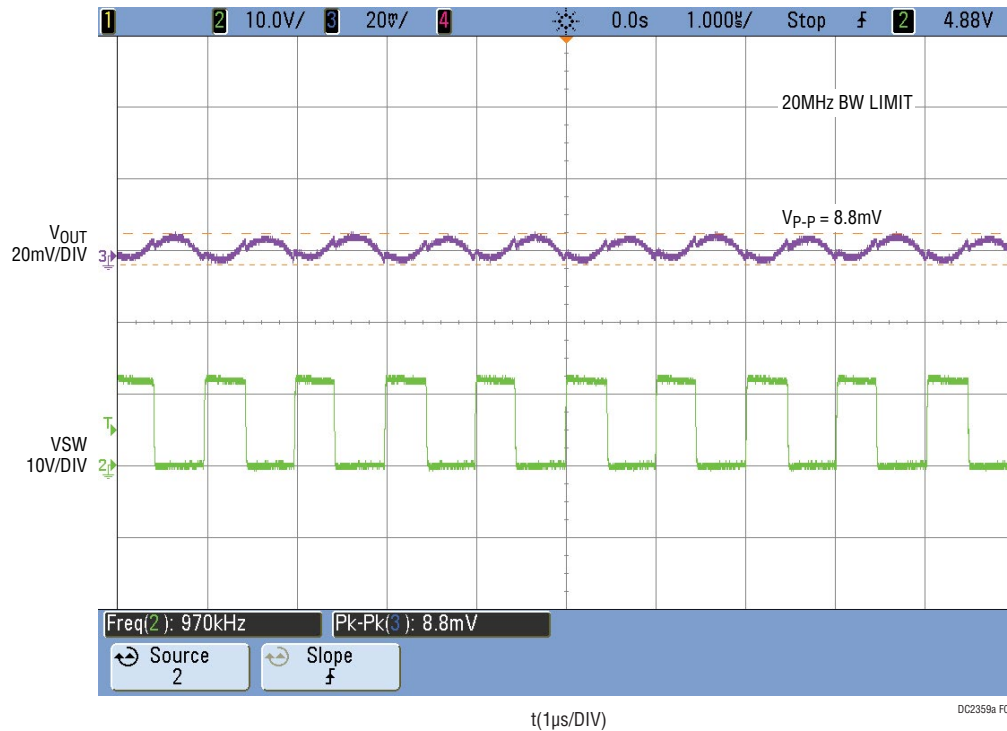

Figure 6. Forced Continuous Mode – Efficiency vs Load Current at 5VIN

**QUICK START PROCEDURE**



$f_{SW} = 1MHz$   
 $V_{IN} = 12V$   
 $V_{OUT} = 5V$   
 $I_{LOAD} = 2A$   
 $L = 3.3\mu H$   
 $C_{OUT} = 1x 47\mu F/6.3V/X5R/1206$

**Figure 7. Measured Output Voltage Ripple**

## QUICK START PROCEDURE

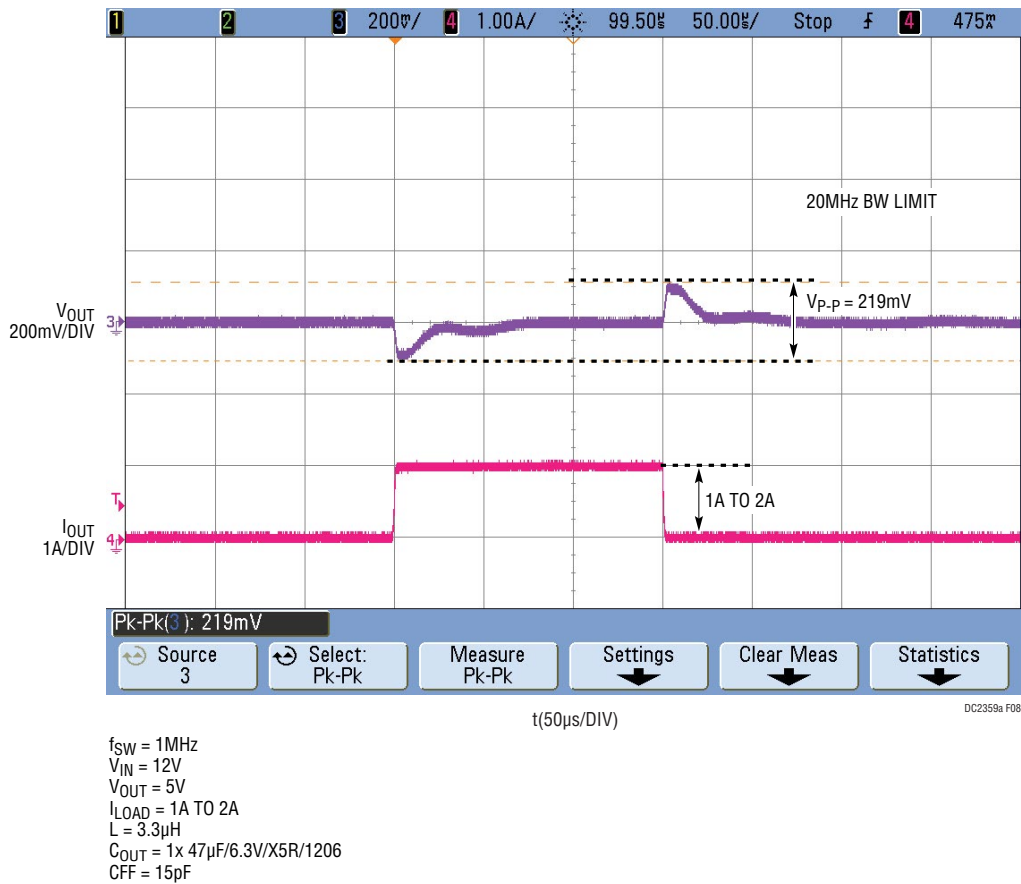

Figure 8. Load Transient Response

**QUICK START PROCEDURE**



$V_{IN} = 12V$   
 $V_{OUT} = 5V$   
 $I_{LOAD} = 2A$   
 $L = 3.3\mu H$   
 $f_{SW} = 1MHz$   
NO FORCED AIRFLOW  
 $T_A = 25^\circ C$

**Figure 9. Thermal Performance**

# DEMO MANUAL DC2359A

## PARTS LIST

ITEM	QTY	REFERENCE	PART DESCRIPTION	MANUFACTURER/PART NUMBER
<b>Required Circuit Components</b>				
1	1	CFF	CAP, 0402 15pF 1% 50V NPO	AVX 04025U150FAT2A
2	1	CIN	CAP, 47μF 20% 20V 33mΩ	PANASONIC OSCON 20SVPA47M
3	2	C2, C3	CAP, 1206 22μF 10% 25V X5R	MURATA GRM31CR61E226KE15L
4	1	C4	CAP, 1206 47μF 20% 6.3V X5R	TAIYO YUDEN JMK316BJ476ML-T
5	1	C8	CAP, 0603 2.2μF 10% 10V X5R	AVX 0603ZD225KAT2A
6	1	L1	IND, 3.3μH	XAL4030-332ME
7	2	R1, RSET	RES, 0402 619kΩ 1% 1/16W	VISHAY CRCW0402619KFKED
8	1	R2	RES, 0402 309kΩ 1% 1/16W	VISHAY CRCW0402309KFKED
9	1	R3	RES, 0402 196kΩ 1% 1/16W	VISHAY CRCW0402196KFKEA
10	1	R4	RES, 0402 137kΩ 1% 1/16W	VISHAY CRCW0402137KFKED
11	1	R5	RES, 0402 84.5kΩ 1% 1/16W	VISHAY CRCW040284K5FKED
12	2	R7, R12	RES, 0402 0Ω JUMPER	VISHAY CRCW04020000Z0ED
13	1	R11	RES, 0402 1MΩ 5% 1/16W	VISHAY CRCW04021M00JNED
14	1	U1	IC, MONOLITHIC SYNCHRONOUS BUCK REGULATOR	LINEAR TECH LTC3624HMSE#PBF
<b>Additional Demo Board Circuit Components</b>				
1	0	C5	CAP, 1206 22μF 20% 6.3V X5R OPTION	TAIYO YUDEN EMK316BJ226ML-T OPTION
2	0	C6	CAP, 1210 OPTION	OPTION
3	0	C7	CAP, 0402 OPTION	OPTION
4	0	R6, R8, R9, R10	RES, 0402 OPTION	OPTION
<b>Hardware</b>				
1	10	E1, E2, E3, E4, E5, E6, E7, E8, E9, E10	TURRET	MILL-MAX 2501-2-00-80-00-00-07-0
2	1	JP1	HEADER, 3-PIN, 2mm	SAMTEC TMM-103-02-L-S
3	1	JP2	HEADER, 4-PIN, 2mm	SAMTEC TMM-104-02-L-S
4	6	JP3, JP4, JP5, JP6, JP7, JP8	HEADER, 2-PIN, 2mm	SAMTEC TMM 102-02-L-S
5	4	MH1, MH2, MH3, MH4	STANDOFF, SNAP ON	KEYSTONE 8833
6	3	XJP1, XJP2, XJP7	SHUNT, 2mm	SAMTEC 2SN-BK-G



**SCHEMATIC DIAGRAM**

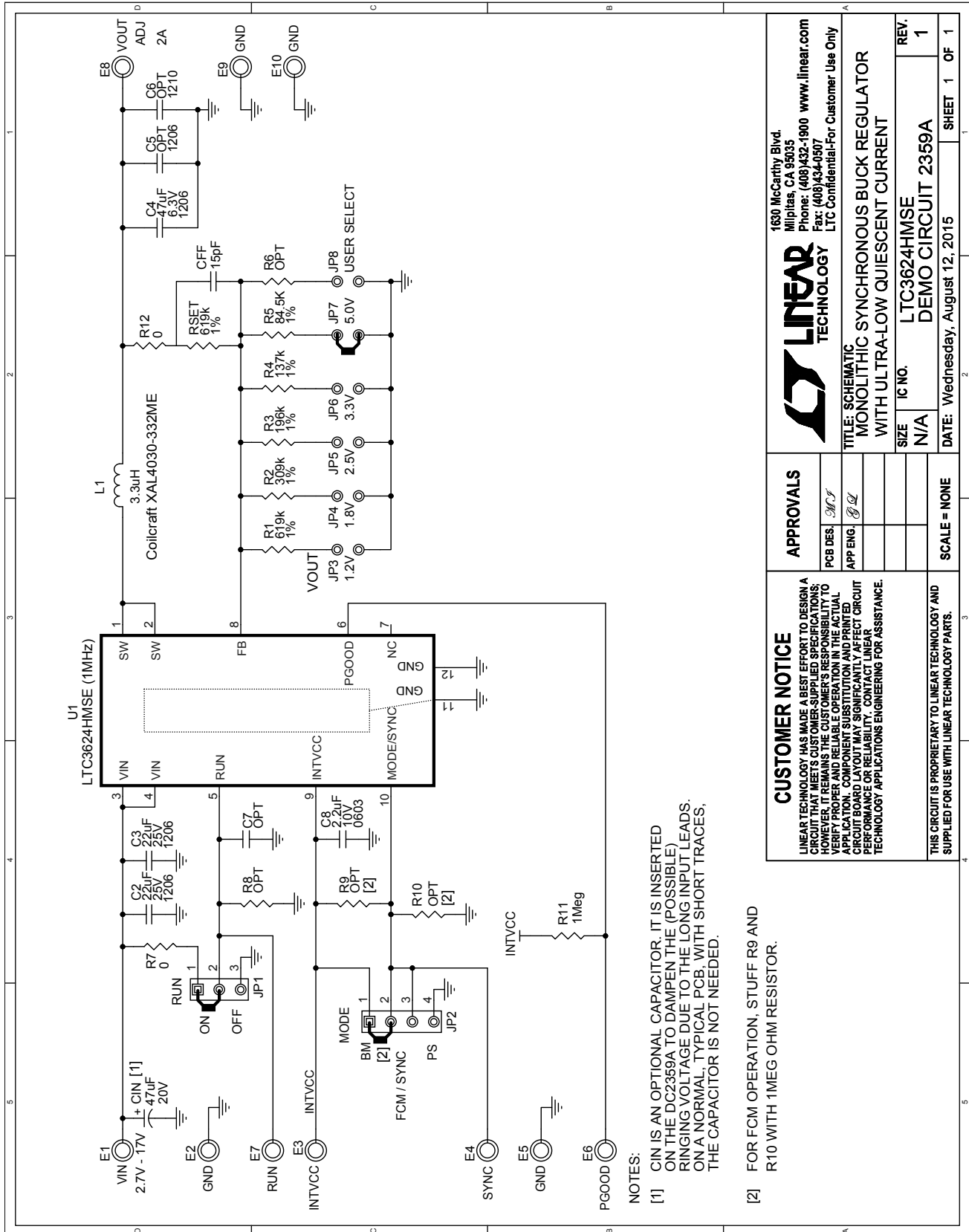

		1630 McCarthy Blvd. Milpitas, CA 95035 Phone: (408)432-1900 www.linear.com Fax: (408)434-0507 LTC Confidential-For Customer Use Only	
<b>APPROVALS</b>		<b>TITLE:</b> SCHEMATIC MONOLITHIC SYNCHRONOUS BUCK REGULATOR WITH ULTRA-LOW QUIESCENT CURRENT	
PCB DES.	MCB	SIZE	IC NO.
APP ENG.	BL	N/A	LTC3624HMSE
		REV.	1
		DATE:	Wednesday, August 12, 2015
		SCALE = NONE	SHEET 1 OF 1
<b>CUSTOMER NOTICE</b> LINEAR TECHNOLOGY HAS MADE A BEST EFFORT TO DESIGN A CIRCUIT THAT MEETS CUSTOMER-SUPPLIED SPECIFICATIONS; HOWEVER, IT REMAINS THE CUSTOMER'S RESPONSIBILITY TO VERIFY PROPER AND RELIABLE OPERATION IN THE ACTUAL APPLICATION. COMPONENT SUBSTITUTION AND PRINTED CIRCUIT BOARD MANUFACTURING VARIATIONS MAY AFFECT CIRCUIT PERFORMANCE OR RELIABILITY. CONTACT LINEAR TECHNOLOGY APPLICATIONS ENGINEERING FOR ASSISTANCE.		THIS CIRCUIT IS PROPRIETARY TO LINEAR TECHNOLOGY AND SUPPLIED FOR USE WITH LINEAR TECHNOLOGY PARTS.	

# DEMO MANUAL DC2359A

---

## DEMONSTRATION BOARD IMPORTANT NOTICE

Linear Technology Corporation (LTC) provides the enclosed product(s) under the following **AS IS** conditions:

This demonstration board (DEMO BOARD) kit being sold or provided by Linear Technology is intended for use for **ENGINEERING DEVELOPMENT OR EVALUATION PURPOSES ONLY** and is not provided by LTC for commercial use. As such, the DEMO BOARD herein may not be complete in terms of required design-, marketing-, and/or manufacturing-related protective considerations, including but not limited to product safety measures typically found in finished commercial goods. As a prototype, this product does not fall within the scope of the European Union directive on electromagnetic compatibility and therefore may or may not meet the technical requirements of the directive, or other regulations.

If this evaluation kit does not meet the specifications recited in the DEMO BOARD manual the kit may be returned within 30 days from the date of delivery for a full refund. **THE FOREGOING WARRANTY IS THE EXCLUSIVE WARRANTY MADE BY THE SELLER TO BUYER AND IS IN LIEU OF ALL OTHER WARRANTIES, EXPRESSED, IMPLIED, OR STATUTORY, INCLUDING ANY WARRANTY OF MERCHANTABILITY OR FITNESS FOR ANY PARTICULAR PURPOSE. EXCEPT TO THE EXTENT OF THIS INDEMNITY, NEITHER PARTY SHALL BE LIABLE TO THE OTHER FOR ANY INDIRECT, SPECIAL, INCIDENTAL, OR CONSEQUENTIAL DAMAGES.**

The user assumes all responsibility and liability for proper and safe handling of the goods. Further, the user releases LTC from all claims arising from the handling or use of the goods. Due to the open construction of the product, it is the user's responsibility to take any and all appropriate precautions with regard to electrostatic discharge. Also be aware that the products herein may not be regulatory compliant or agency certified (FCC, UL, CE, etc.).

No License is granted under any patent right or other intellectual property whatsoever. **LTC assumes no liability for applications assistance, customer product design, software performance, or infringement of patents or any other intellectual property rights of any kind.**

LTC currently services a variety of customers for products around the world, and therefore this transaction **is not exclusive**.

**Please read the DEMO BOARD manual prior to handling the product.** Persons handling this product must have electronics training and observe good laboratory practice standards. **Common sense is encouraged.**

This notice contains important safety information about temperatures and voltages. For further safety concerns, please contact a LTC application engineer.

Mailing Address:

Linear Technology  
1630 McCarthy Blvd.  
Milpitas, CA 95035

Copyright © 2004, Linear Technology Corporation