

## Specification

Part No.	: <b>GPSDSF.35.7.A.08</b>
Product Name	: Embedded 2in1 Low Profile Stacked Patch for GPS/GLONASS/Galileo & SDARS (XM)
Feature	: Highest Efficiency and Gain GPS: 69.8% Efficiency @1575.42 MHz GLONASS: 78.6% Efficiency @1602 MHz SDARS (XM): 67.6% Efficiency @2338.75 MHz AR values: GPS: 5.0 dB typ. GLONASS: 7.5 dB typ. SDARS(XM): 3.8 dB typ. RHCP on GPS and GLONASS / LHCP on SDARS Ground-plane Through-Hole Mounting Pin Type Dual Feed Patch Assembly Dimensions: 35*35*7.15mm Tuned for Centre Positioning on a 70*70mm <b>RoHS Compliant</b>



## 1. Introduction

The GPSDSF.35.7.A.08 is a passive 35x35mm ceramic stacked patch antenna with both SDARS and GNSS capabilities. This patch provides world-class performance for both SDARS and GNSS services, with AR GPS:5.0 dB typ, GLONASS: 7.5 dB typ. SDARS(XM): 3.8 dB typ right hand circular polarization and nearly 70% efficiency at 2332.5 MHz for SDARS and 70-80% efficiency at GPS/GLONASS/GALILEO frequencies. Using one patch for both services results in the most economical and space-efficient solution for demanding applications requiring both SDARS and GNSS functionality. At just 7.15 mm in height, the GPSDSF.35 is also extremely low-profile.

Typical Applications:

- OEM Sharkfin Automotive Antennas
- Truck Mounted Antenna Systems

This antenna has been tuned and tested on a 70 x 70 mm ground plane. Custom tuning services can be provided for further optimization to customer-specific device environments. Contact your regional Taoglas sales office for support.



## 2. Specification

Electrical	
Frequency	GPS: 1575.42 ± 1.023 MHz GLONASS: 1602 ± 5MHz SDARS(XM) : 2338.75 ± 6.25 MHz
Centre Frequency	1591 ± 3 MHz 2338.75 ± 3 MHz
Return Loss	GPS: -10dB max. GLONASS: -10dB max. SDARS(XM): -10dB max.
Zenith Gain	GPS: +3.4 dBi typ. GLONASS: +3.6 dBi typ. SDARS(XM): +4.7 dBi typ.
Efficiency	GPS: 69 % GLONASS: 78 % SDARS(XM): 67 %
Axial Ratio at Zenith	GPS: 5.0 dB typ. GLONASS: 7.5 dB typ. SDARS(XM): 3.8 dB typ.
Polarization	R.H.C.P. For GPS/ GLONASS L.H.C.P. For SDARS(XM)
Impedance	50 Ω
Mechanical	
Dimensions	35 x 35 x 7.15mm GPS: 35 x 35 x 4 mm SDARS: 25 x 25 x 3 mm
Material	Ceramic
Pin Diameter	0.8mm
Pin Length	2.4mm
Weight	22.1g
ENVIRONMENTAL	
Operation Temperature	-40°C to +85°C
Humidity	Non-condensing 65°C 95% RH

\* Antenna properties were measured with the antenna mounted on 70\*70mm Ground Plane

### 3. Antenna Characteristics

#### 3.1 Return Loss

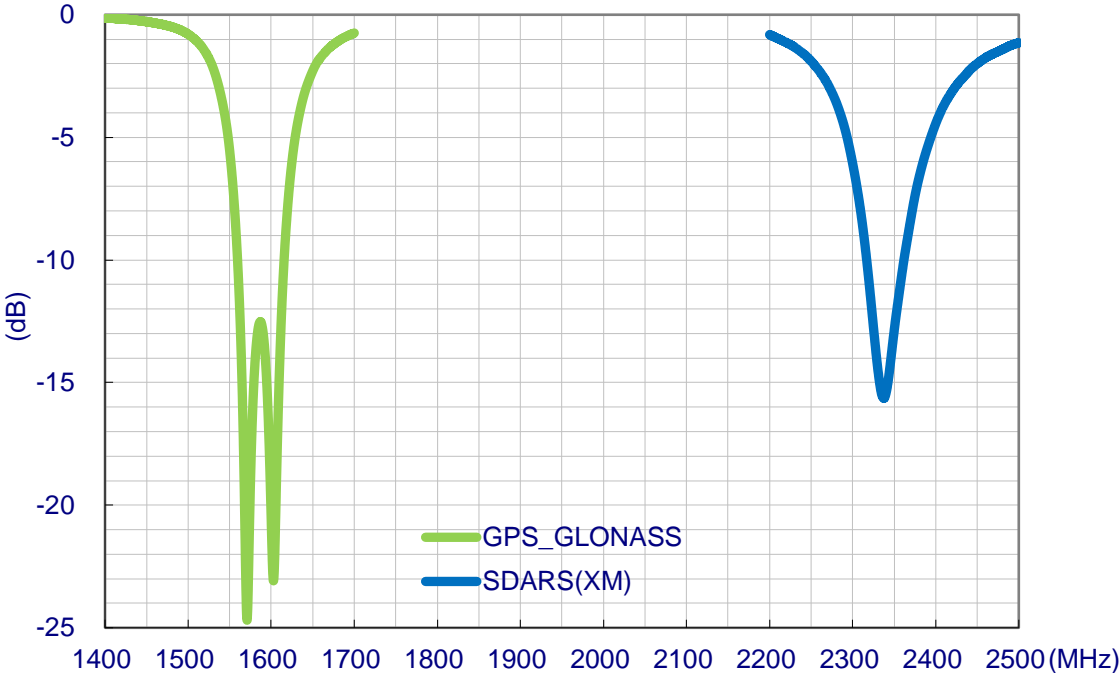

#### 3.2 Efficiency

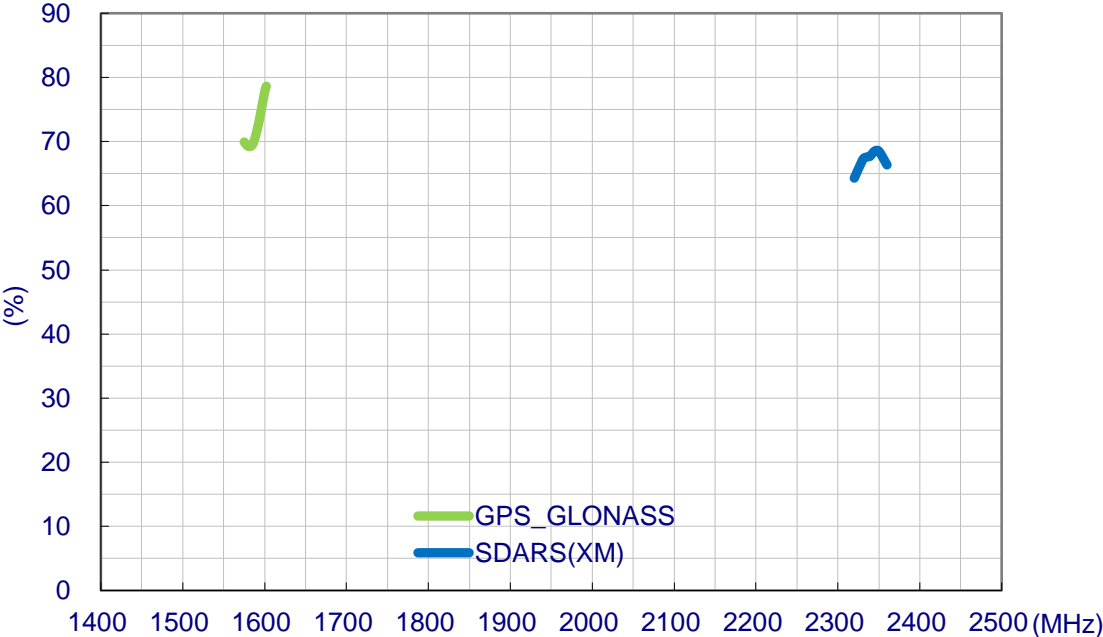

### 3.3 Average Gain

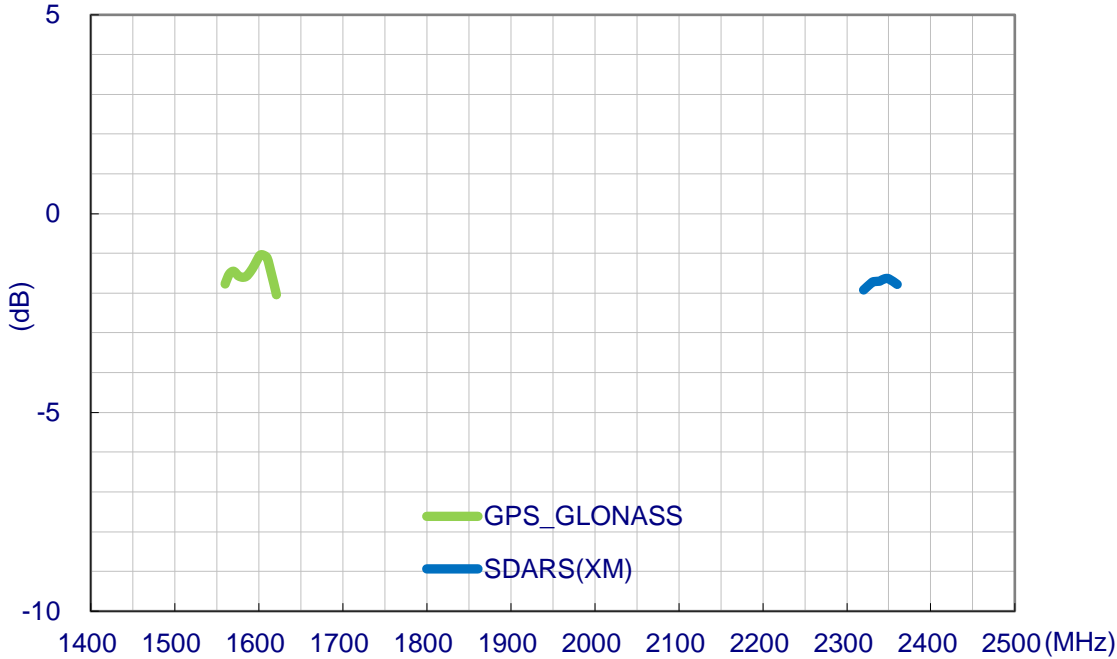

### 3.4 Peak Gain

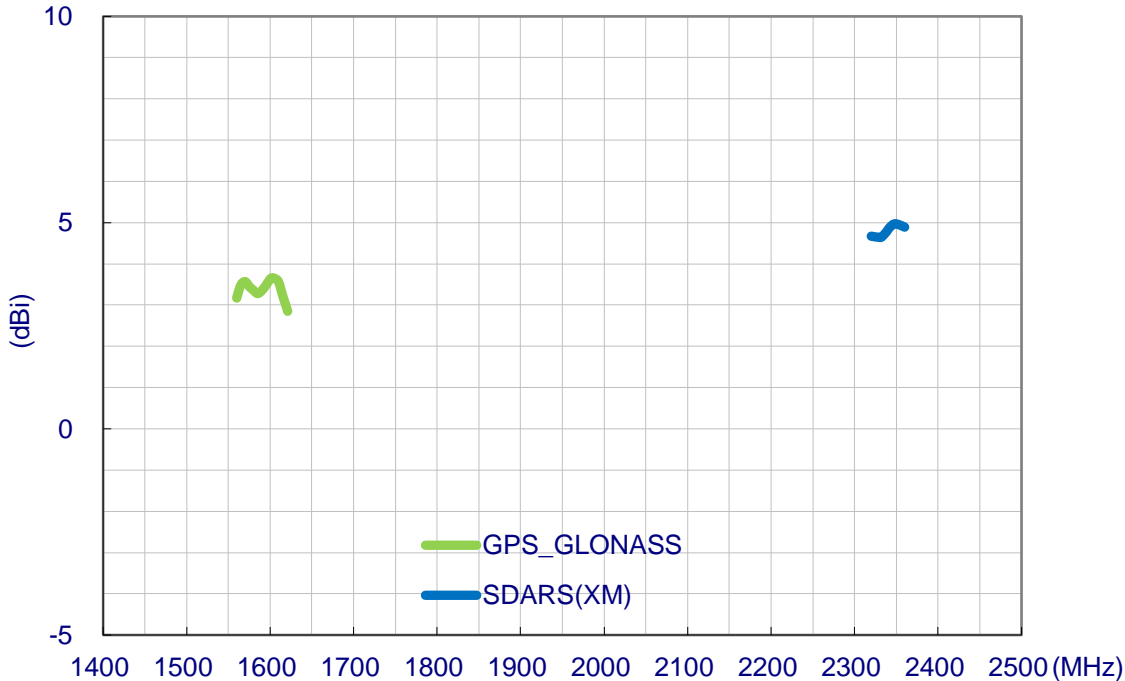

**3.5 Axial Ratio (Zenith is at 0°)**

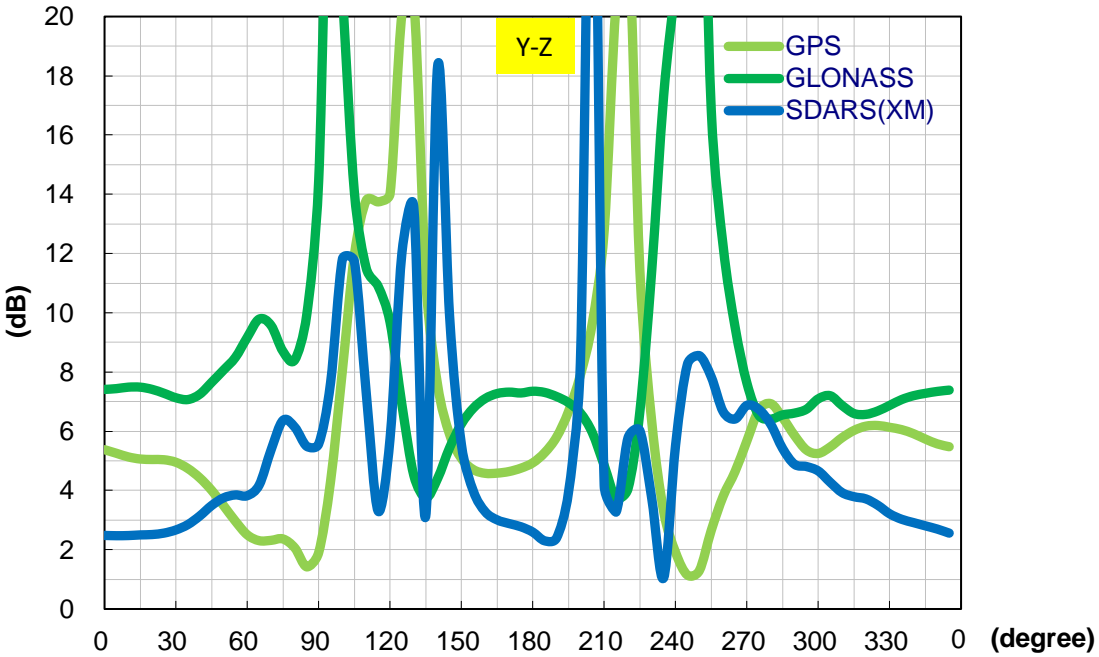
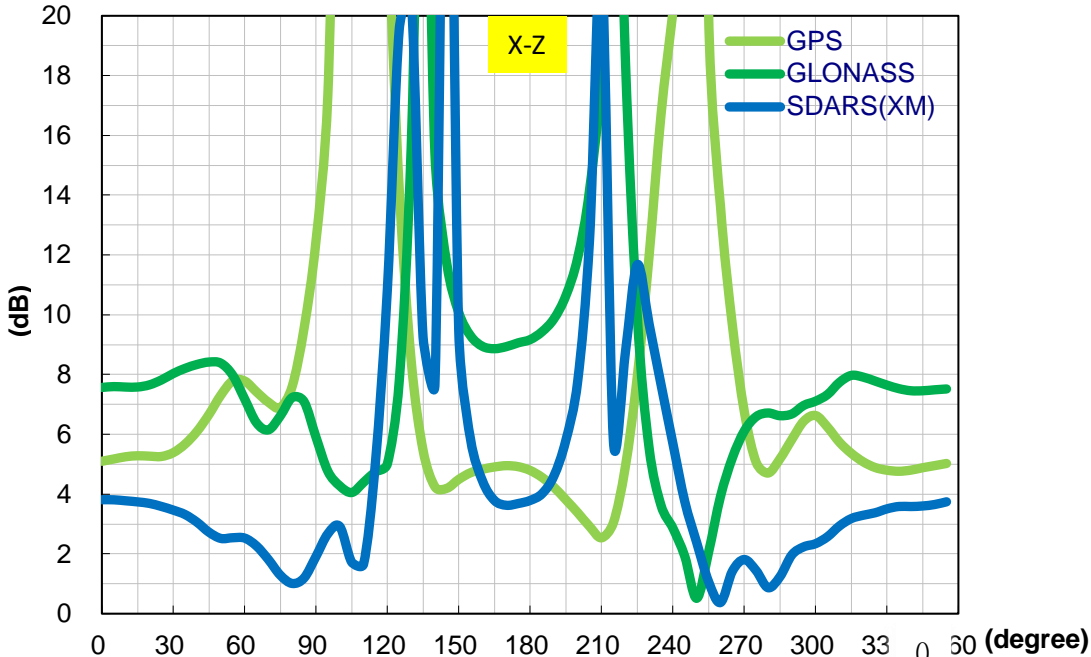

### 3.6 Isolation

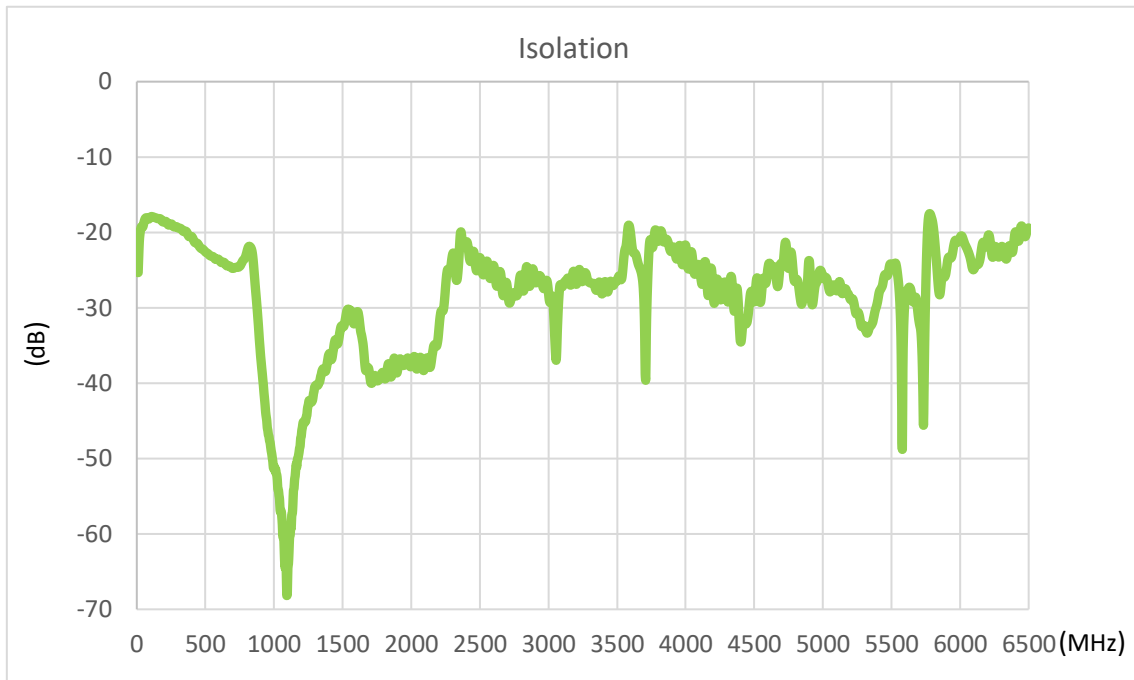

### 3.7 XM Gain Requirements (Satellite) – Ground Plane

AUT Location	Elevation Angle(degrees)	Linear Average Gain(dBic)
Passive Ground Plane	$20 \leq \phi \leq 25$	-1.3
	$25 \leq \phi \leq 30$	-0.7
	$30 \leq \phi \leq 50$	0.8
	$50 \leq \phi \leq 70$	2.9
	$70 \leq \phi \leq 90$	3.9

### XM Gain Requirements (Terrestrial) – Ground Plane

AUT Location	Elevation Angle(degrees)	Antenna Mean Passive VP Gain Over Solid Angle (dBi)	Antenna P/P Gain variation (dB)
Passive Ground Plane	$0^\circ \leq \phi \leq 10^\circ$	-5.7	-
	$\phi = 5^\circ$	-	4.3



## 4. Antenna Radiation Pattern

### 4.1 Measurement Setup

The GPSDSF.35.7.A.08 antenna is tested on a 70 x 70mm ground plane in a CTIA certified Anechoic Chamber. The test setup is shown below.

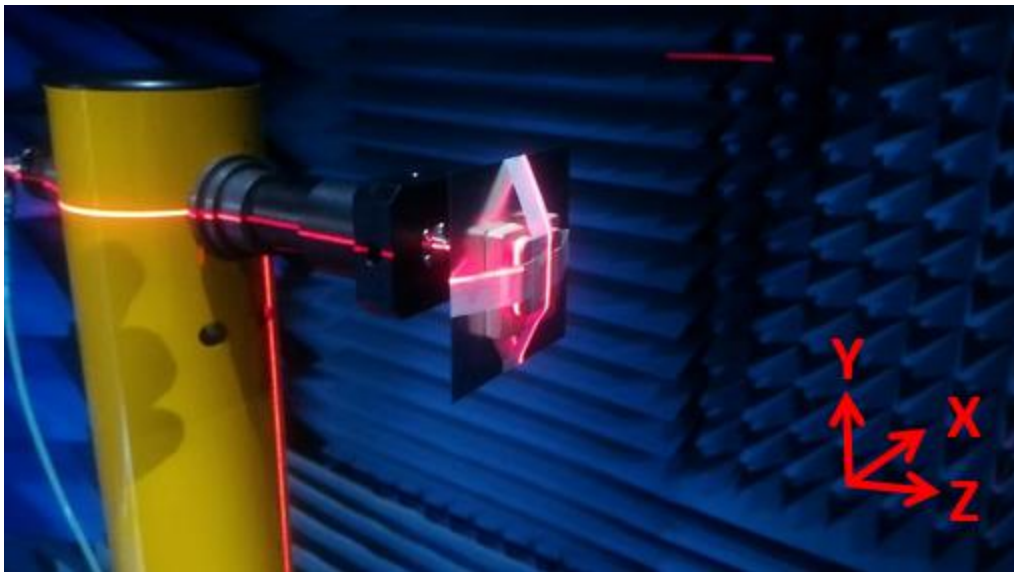

### 4.2 2D Radiation Pattern

X-Y Plane

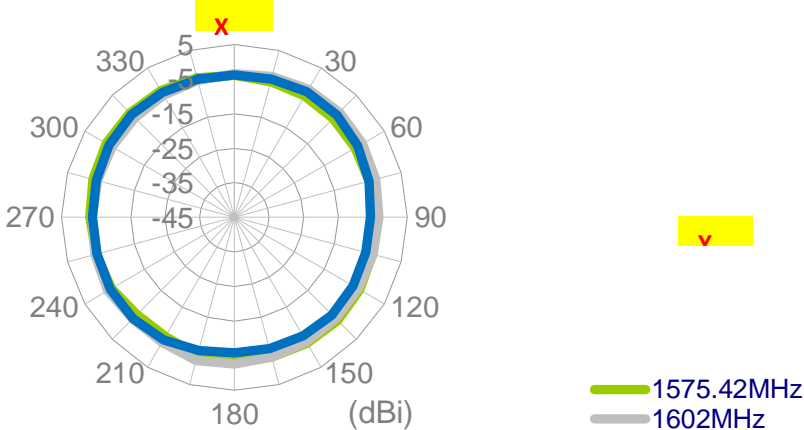

X-Z Plane

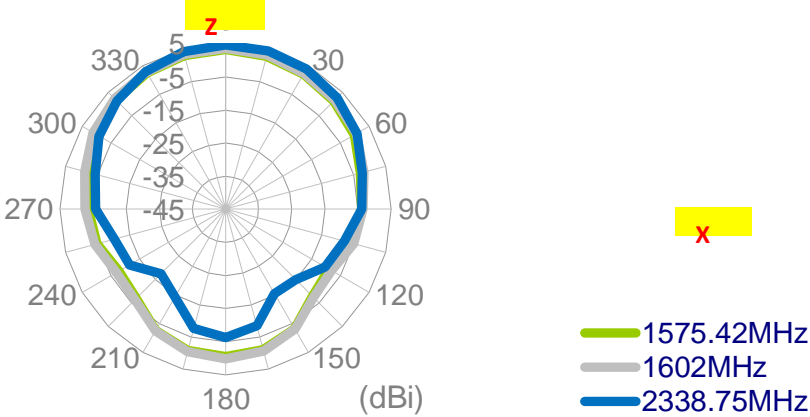

Y-Z Plane

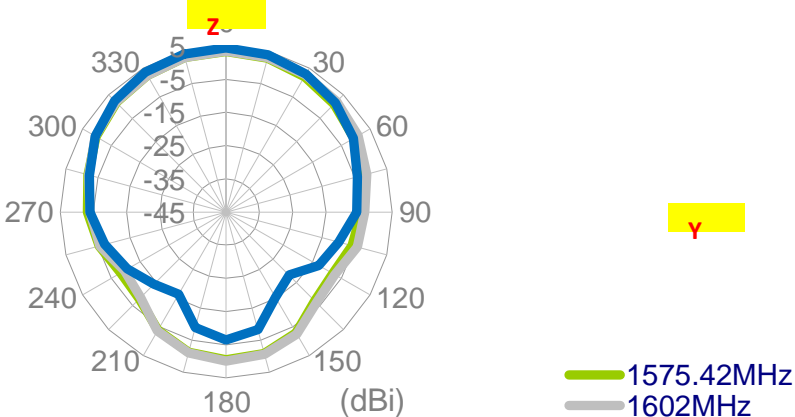

# 5. 3D Radiation Pattern

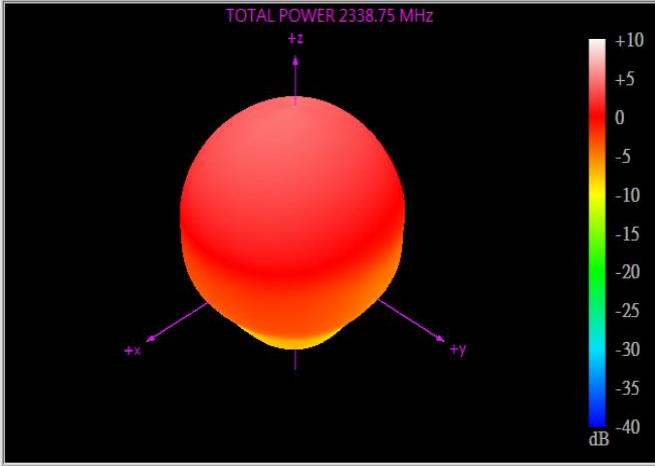
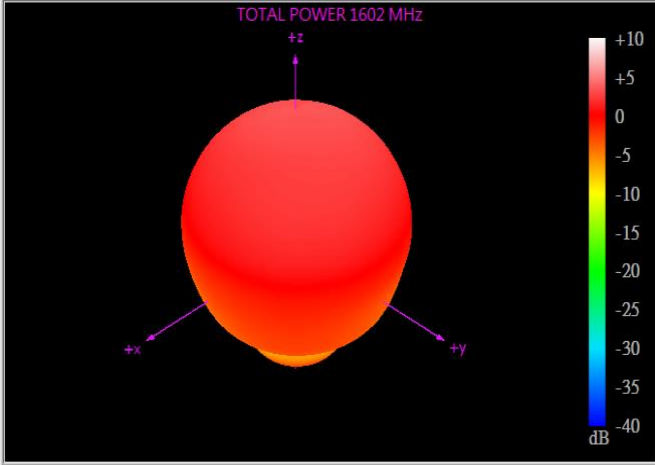
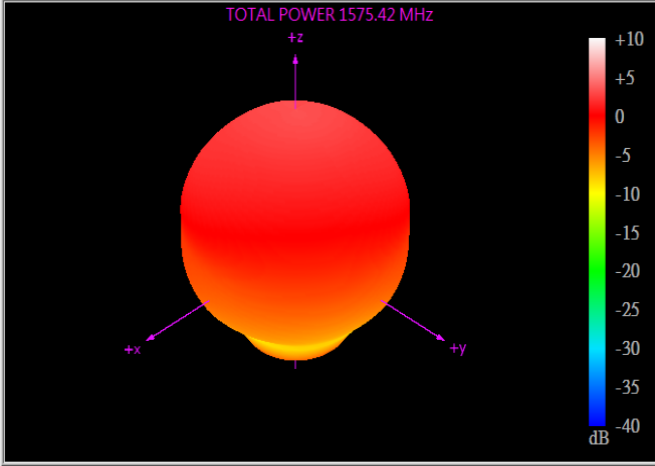

## 6. Mechanical Drawing (Unit:mm)

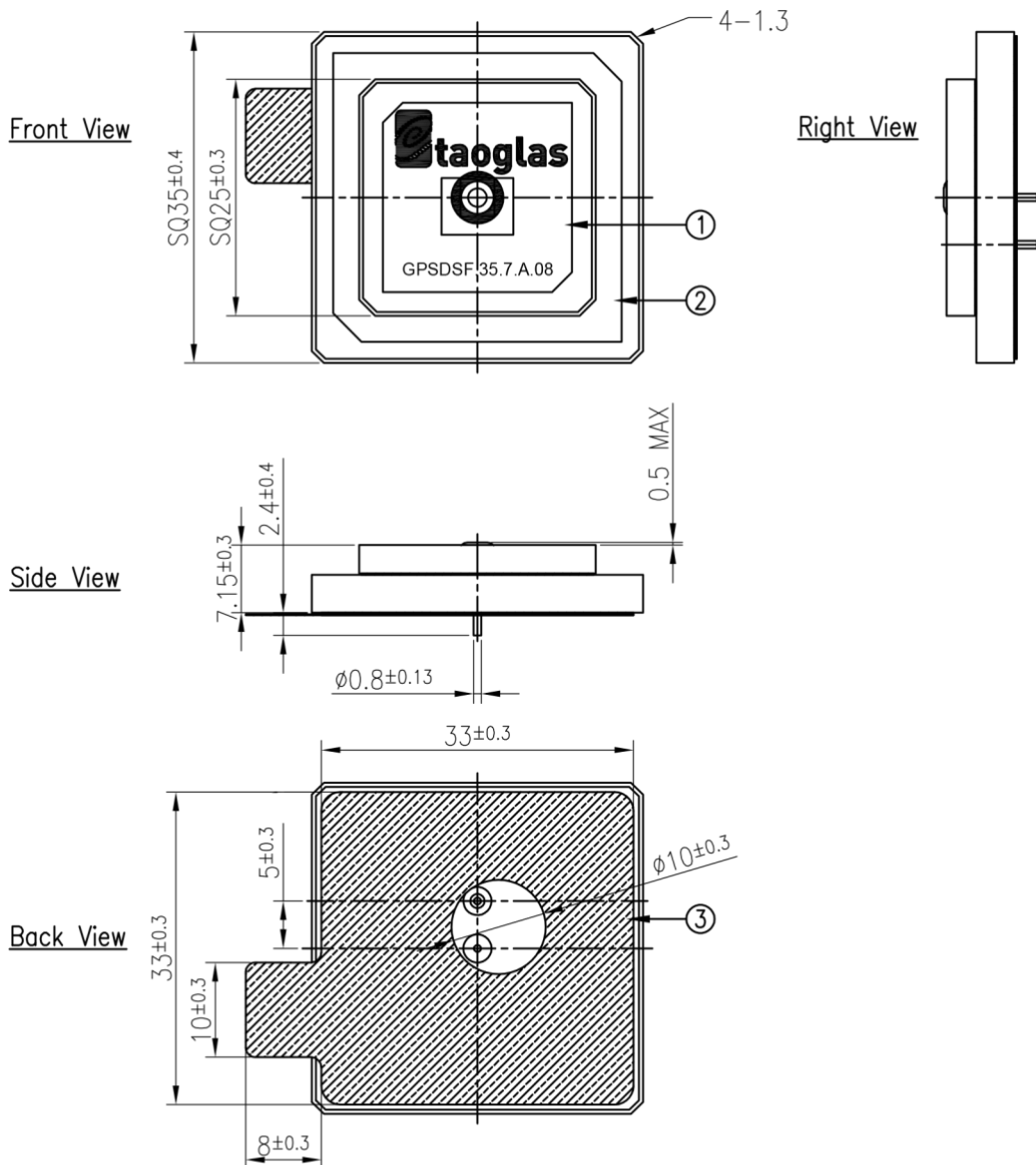

NOTES: 1. Double Sided Adhesive Area.   
 2. Soldermask Area 

	Name	P/N	Material	Finish	QTY
1	Patch-1 (25x25x3mm)	001517J120000A	Ceramic	Clear	1
2	Patch-2 (35x35x4mm)	001517J130000A	Ceramic	Clear	1
3	Double Sided Adhesive	001517J130000A	NITTO 5015	White Linter	1

# 7. Feed Pin Pad Layout Recommendation

(unit:mm)

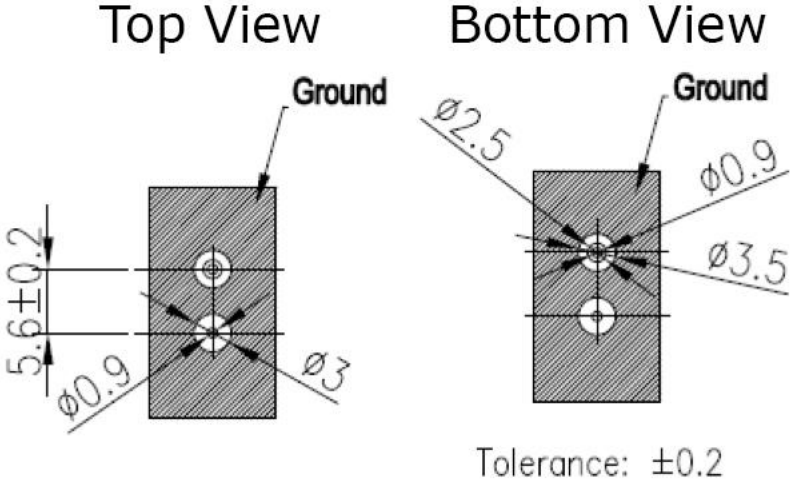

## **8. Evaluation Board - (Unit:mm)**

**GPSDFSFD.35.7.A.08**

Front View

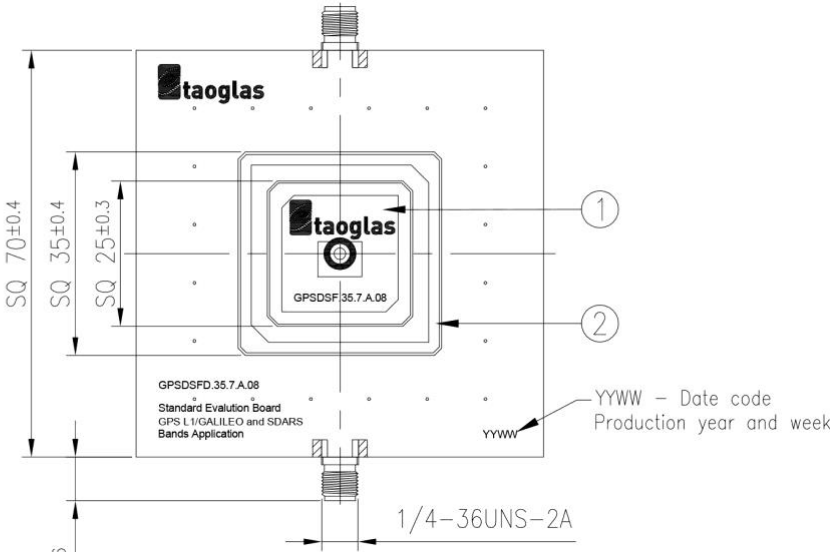

Side View

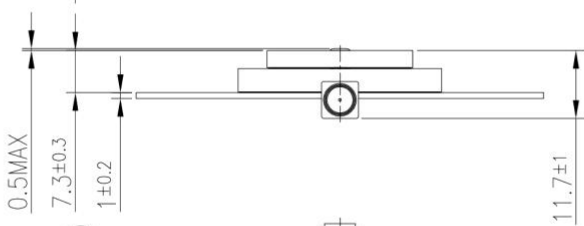

Back View

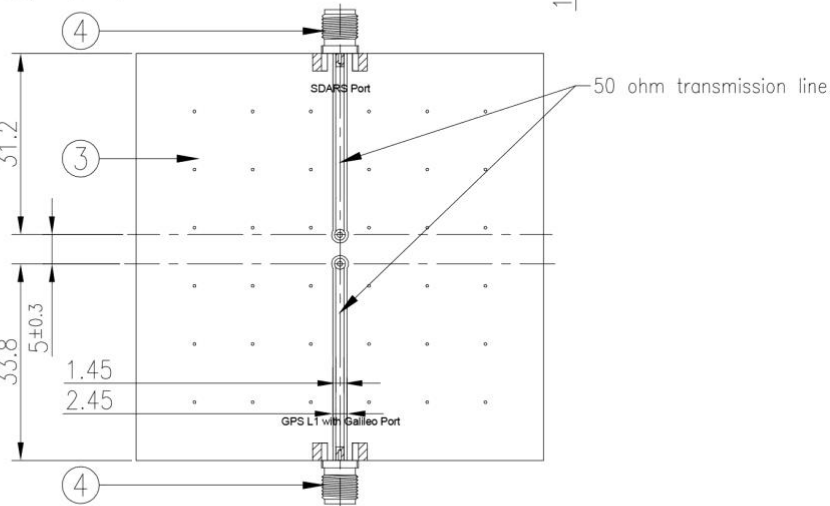

	Name	Material	Finish	QTY
1	Patch-1 (25x25x3mm)	Ceramic	Clear	1
2	Patch-2 (35x35x4mm)	Ceramic	Clear	1
3	PCB	Composite 1t	Black	1
4	SMA(F)ST	Brass	Au Plated	2

# 9. Packaging

30 pcs GPSDSF.35.7.A.08 per Tray  
 Tray Dimensions - 300\*370\*30mm  
 Weight - 848g

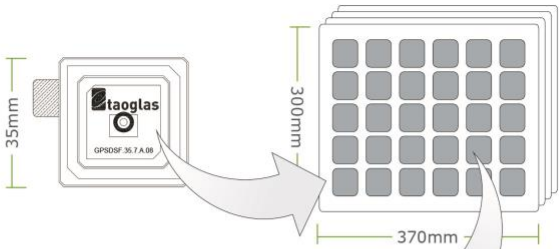

120 pcs GPSDSF.35.7.A.08 per Vacuum Bag  
 Vacuum Bag Dimensions - 300\*370\*50mm  
 Weight - 3.4kg

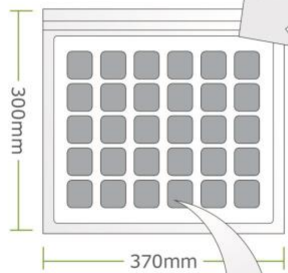

360 pcs GPSDSF.35.7.A.08 per Carton  
 Carton Dimensions - 390\*320\*270mm  
 Weight - 13.07kg

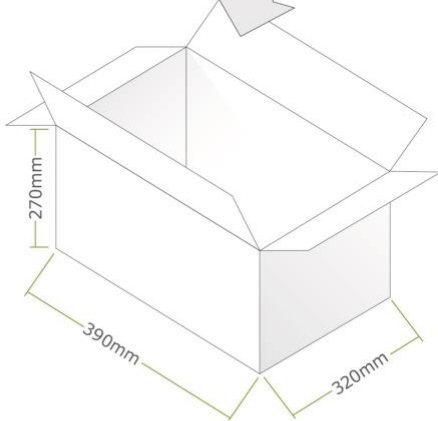

Pallet Dimensions:  
 1200mm\*1000mm\*1280mm  
 36 Cartons per Pallet  
 9 Cartons per Layer, 4 Layers

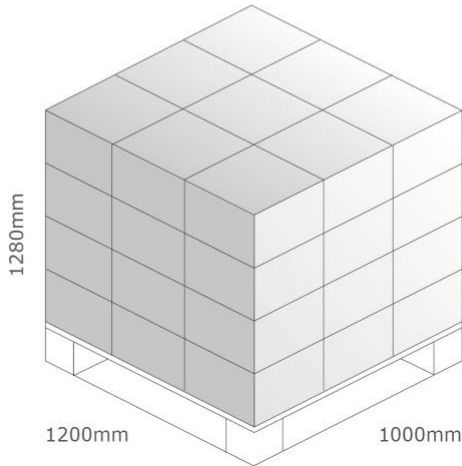



Taoglas makes no warranties based on the accuracy or completeness of the contents of this document and reserves the right to make changes to specifications and product descriptions at any time without notice.

Taoglas reserves the rights to this document and the information contained herein. Reproduction, use or disclosure to third parties without express permission is strictly prohibited.

Copyright © Taoglas Ltd.