

SC-02-20G

Aliases (UALSC0220G0000)

KEMET, SC-G/GS, AC Line Filters, Common Mode, 2 mH

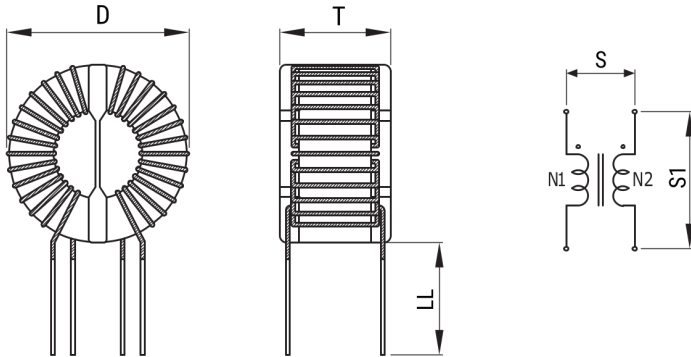

Click [here](#) for the 3D model.

Dimensions

D	17.5mm MAX
T	14mm MAX
LL	15mm +/-2mm
S	8mm NOM
S1	13mm NOM
Wire Size	0.5mm

Packaging Specifications

Packaging	Tray
Packaging Quantity	1300
Component Weight	8 g

General Information

Series	SC-G/GS
Style	Through-Hole
RoHS	Yes
Notes	Lead Spacing (S/S1) Are For Reference Only.
Miscellaneous	Temperature Rise Maximum: 40 K.
Core	Mn-Zn Ferrite

Specifications

Voltage AC	250 VAC
Inductance	2 mH (100 kHz)
Current	2 A
Temperature Range	-25/+105°C
DC Resistance	70 mOhms