

## High Voltage LED Series Chip on Board

# LCo16D – Gen.1



High efficacy COB LED package  
well-suited for use in spotlight applications

### Features & Benefits

- Chip on Board (COB) solution makes it easy to design in
- Simple assembly reduces manufacturing cost
- Low thermal resistance
- InGaN/GaN MQW LED with long time reliability

### Applications

- Spotlight / Downlight
- LED Retrofit Bulbs
- Outdoor Illumination



## Table of Contents

1.	Characteristics	-----	3
2.	Product Code Information	-----	5
3.	Typical Characteristics Graphs	-----	9
4.	Outline Drawing & Dimension	-----	12
5.	Reliability Test Items & Conditions	-----	13
6.	Label Structure	-----	14
7.	Packing Structure	-----	15
8.	Precautions in Handling & Use	-----	17

## 1. Characteristics

### a) Absolute Maximum Rating

Item	Symbol	Rating	Unit	Condition
Ambient / Operating Temperature	$T_a$	-40 ~ +105	°C	-
Storage Temperature	$T_{stg}$	-40 ~ +120	°C	-
LED Junction Temperature	$T_J$	140	°C	-
Case Temperature	$T_c$	105	°C	-
Forward Current	$I_F$	1150	mA	-
Power Dissipation	$P_D$	43.1	W	-
ESD (HBM)	-	±2	kV	-
ESD (MM)	-	±0.5	kV	-

### b) Electro-optical Characteristics ( $I_F = 450 \text{ mA}$ , $T_J = 85 \text{ °C}$ )

Item	Unit	Rank	Min.	Typ.	Max.
Forward Voltage ( $V_F$ )	V	YZ	31.8	34.6	37.5
Color Rendering Index ( $R_a$ )	-	5	80	-	-
		7	90	-	-
Thermal Resistance (junction to chip point)	°C/W		-	1.1	-
Beam Angle	°		-	115	-
Nominal Power	W			16.9	

#### Notes:

- 1) The COB is tested in pulsed condition at rated test current (10 ms pulse width) and rated temperature ( $T_J = T_C = T_a = 85 \text{ °C}$ )
- 2) Samsung maintains measurement tolerance of: forward voltage = ±5 %, CRI = ±1
- 3) Refer to the derating curve, '3. Typical Characteristics Graph' designed within the range.

c) Luminous Flux Characteristics ( $I_F = 450 \text{ mA}$ )

CRI ( $R_a$ ) Min.	Nominal CCT (K)	Flux Rank	Flux Bin	Flux @ $T_J = 85^\circ\text{C}$ (lm)		
				Min.	Typ.	Max.
80	2700	H9	H9	1962	2065	-
		D1	D1	2065	2169	-
	3000	J0	J0	2073	2182	-
		D1	D1	2182	2291	-
	3500	J1	J1	2150	2263	-
		D1	D1	2263	2376	-
	4000	J1	J1	2189	2304	-
		D1	D1	2304	2419	-
	5000	J2	J2	2208	2324	-
		D1	D1	2324	2440	-
	5700	J2	J2	2208	2324	-
		D1	D1	2324	2440	-
	6500	J1	J1	2189	2304	-
		D1	D1	2304	2419	-

CRI ( $R_a$ ) Min.	Nominal CCT (K)	Flux Rank	Flux Bin	Flux @ $T_J = 85^\circ\text{C}$ (lm)		
				Min.	Typ.	Max.
90	2700	H6	H6	1683	1771	-
		D1	D1	1771	1860	-
	3000	H7	H7	1783	1877	-
		D1	D1	1877	1970	-
	3500	H8	H8	1836	1932	-
		D1	D1	1932	2029	-
	4000	H8	H8	1872	1971	-
		D1	D1	1971	2069	-
	5000	H8	H8	1890	1989	-
		D1	D1	1989	2089	-

**Notes:**

- 1) The COB is tested in pulsed operating condition at rated test current (10 ms pulse width) and rated temperature ( $T_J = T_C = 85^\circ\text{C}$ ).
- 2) Samsung maintains measurement tolerance of: Luminous flux =  $\pm 7\%$ , CRI =  $\pm 1$

## 2. Product Code Information

1	2	3	4	5	6	7	8	9	10	11	12	13	14	15	16	17	18
S	P	H	W	H	A	H	D	N	E	2	5	Y	Z	W	3	H	9

Digit	PKG Information	Code	Specification
1 2 3	Samsung Package High Power	<b>SPH</b>	
4 5	Color	<b>WH</b>	White
6	Product Version	<b>A</b>	
7 8	Form Factor	<b>HD</b>	COB
9	Lens Type	<b>N</b>	No lens
10	Wattage or Model	<b>E</b>	LC016D
11	Internal Code	<b>2</b>	
12	CRI & Sorting Temperature	<b>5</b> <b>7</b>	Min. 80 (85°C) Min. 90 (85°C)
13 14	Forward Voltage (V)	<b>YZ</b>	31.8~37.5
15	CCT (K)	<b>W</b> <b>V</b> <b>U</b> <b>T</b> <b>R</b> <b>Q</b> <b>P</b>	2700K 3000K 3500K 4000K 5000K 5700K 6500K
16	MacAdam Step	<b>2</b> <b>3</b>	MacAdam 2-step MacAdam 3-step
17 18	Luminous Flux (Lm)	<b>H6</b> <b>H7</b> <b>H8</b> <b>H9</b> <b>J0</b> <b>J1</b> <b>J2</b> <b>D1</b>	Min. 1600 Min. 1700 Min. 1800 Min. 1900 Min. 2000 Min. 2100 Min. 2200 Add rank

a) Binning Structure ( $I_F = 450 \text{ mA}$ ,  $T_J = 85 \text{ }^\circ\text{C}$ )

CRI (Ra) Min.	Nominal CCT (K)	Product Code	V <sub>F</sub> Rank	Color Rank	Flux Rank	Flux Range (Φ <sub>v</sub> , lm)
80	2700	SPHWAHDNE25YZW2H9	YZ	W2	H9	1962 ~
		SPHWAHDNE25YZW3H9		W3		
		SPHWAHDNE25YZW2D1		W2	D1	2065 ~
		SPHWAHDNE25YZW3D1		W3		
	3000	SPHWAHDNE25YZV2J0	YZ	V2	J0	2073 ~
		SPHWAHDNE25YZV3J0		V3		
		SPHWAHDNE25YZV2D1		V2	D1	2182 ~
		SPHWAHDNE25YZV3D1		V3		
	3500	SPHWAHDNE25YZU2J1	YZ	U2	J1	2150 ~
		SPHWAHDNE25YZU3J1		U3		
		SPHWAHDNE25YZU2D1		U2	D1	2263 ~
		SPHWAHDNE25YZU3D1		U3		
	4000	SPHWAHDNE25YZT2J1	YZ	T2	J1	2189 ~
		SPHWAHDNE25YZT3J1		T3		
		SPHWAHDNE25YZT2D1		T2	D1	2324 ~
		SPHWAHDNE25YZT3D1		T3		
	5000	SPHWAHDNE25YZR3J2	YZ	R3	J2	2208 ~
		SPHWAHDNE25YZR3D1			D1	2324 ~
	5700	SPHWAHDNE25YZQ3J2	YZ	Q3	J2	2208 ~
		SPHWAHDNE25YZQ3D1			D1	2324 ~
6500	SPHWAHDNE25YZP3J1	YZ	P3	J1	2189 ~	
	SPHWAHDNE25YZP3D1			D1	2304 ~	

CRI (R <sub>a</sub> ) Min.	Nominal CCT (K)	Product Code	V <sub>F</sub> Rank	Color Rank	Flux Rank	Flux Range (Φ <sub>v</sub> , lm)
90	2700	SPHWAHDNE27YZW2H6	YZ	W2	H6	1683 ~
		SPHWAHDNE27YZW3H6		W3		
		SPHWAHDNE27YZW2D1		W2	D1	1771 ~
		SPHWAHDNE27YZW3D1		W3		
	3000	SPHWAHDNE27YZV2H7	YZ	V2	H7	1783 ~
		SPHWAHDNE27YZV3H7		V3		
		SPHWAHDNE27YZV2D1		V2	D1	1877 ~
		SPHWAHDNE27YZV3D1		V3		
	3500	SPHWAHDNE27YZU2H8	YZ	U2	H8	1836 ~
		SPHWAHDNE27YZU3H8		U3		
		SPHWAHDNE27YZU2D1		U2	D1	1932 ~
		SPHWAHDNE27YZU3D1		U3		
	4000	SPHWAHDNE27YZT2H8	YZ	T2	H8	1872 ~
		SPHWAHDNE27YZT3H8		T3		
		SPHWAHDNE27YZT2D1		T2	D1	1971 ~
		SPHWAHDNE27YZT3D1		T3		
	5000	SPHWAHDNE27YZR3H8	YZ	R3	H8	1890 ~
		SPHWAHDNE27YZR3D1		R3	D1	1989 ~

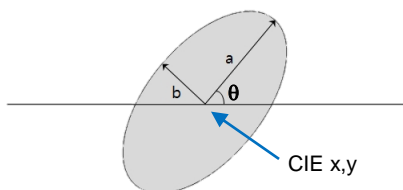
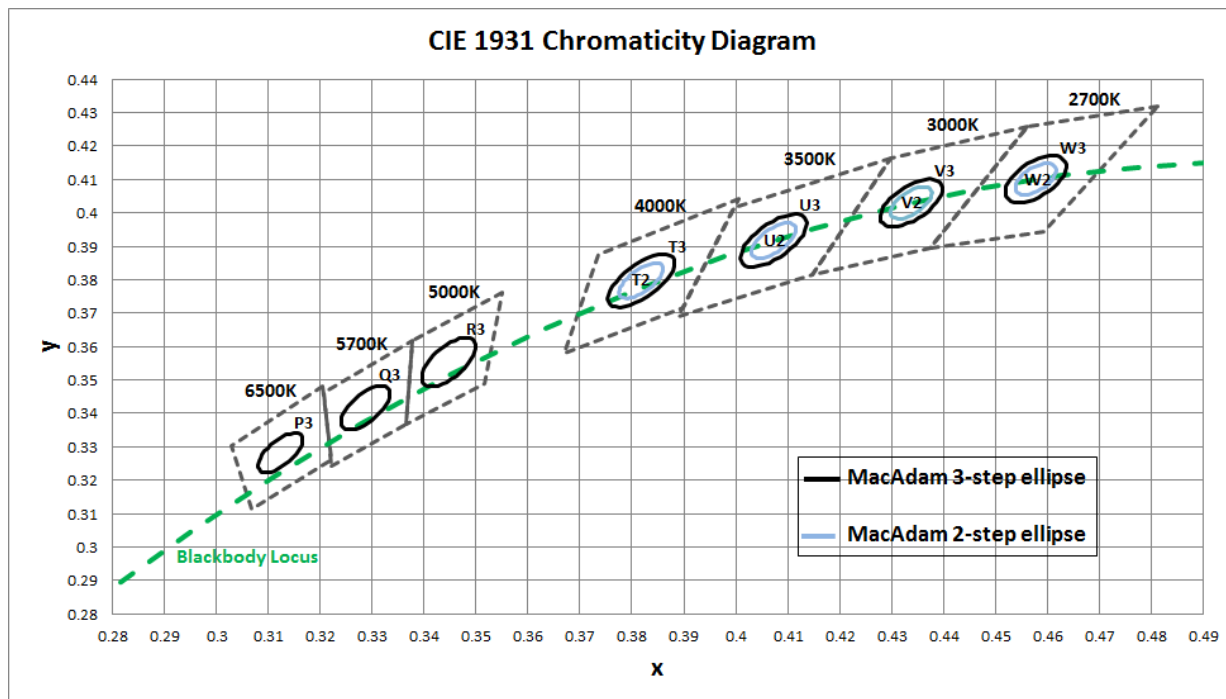
b) Chromaticity Region & Coordinates ( $I_F = 450 \text{ mA}$ ,  $T_J = 85 \text{ }^\circ\text{C}$ )

MacAdam Ellipse (W2, W3)					
Step	CIE x	CIE y	$\theta$	a	b
2-step	0.4578	0.4101	53.70	0.0054	0.0028
3-step	0.4578	0.4101	53.70	0.0081	0.0042

MacAdam Ellipse (V2, V3)					
Step	CIE x	CIE y	$\theta$	a	b
2-step	0.4338	0.403	53.22	0.0056	0.0027
3-step	0.4338	0.4030	53.22	0.0083	0.0041

MacAdam Ellipse (U2, U3)					
Step	CIE x	CIE y	$\theta$	a	b
2-step	0.4073	0.3917	54.00	0.0062	0.0028
3-step	0.4073	0.3917	54.00	0.0093	0.0041

MacAdam Ellipse (T2, T3)					
Step	CIE x	CIE y	$\theta$	a	b
2-step	0.3818	0.3797	53.72	0.0063	0.0027
3-step	0.3818	0.3797	53.72	0.0094	0.0040

MacAdam Ellipse (R3)					
Step	CIE x	CIE y	$\theta$	a	b
3-step	0.3447	0.3553	59.62	0.0082	0.0035

MacAdam Ellipse (Q3)					
Step	CIE x	CIE y	$\theta$	a	b
3-step	0.3287	0.3417	59.0950	0.0075	0.0032

MacAdam Ellipse (P3)					
Step	CIE x	CIE y	$\theta$	a	b
3-step	0.3123	0.3282	58.5700	0.0067	0.0029

**Note:**

Samsung maintains measurement tolerance of:  $C_x, C_y = \pm 0.005$



### 3. Typical Characteristics Graphs

#### a) Spectrum Distribution ( $I_f = 450 \text{ mA}$ , $T_J = 85 \text{ }^\circ\text{C}$ )

CCT: 2700 K (80 CRI)

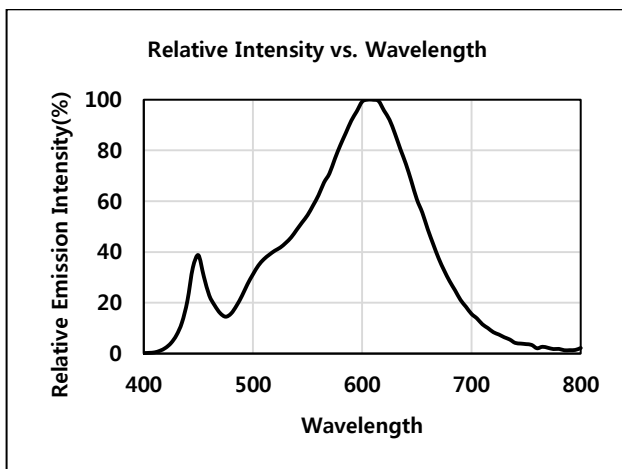

CCT: 3000 K (80 CRI)

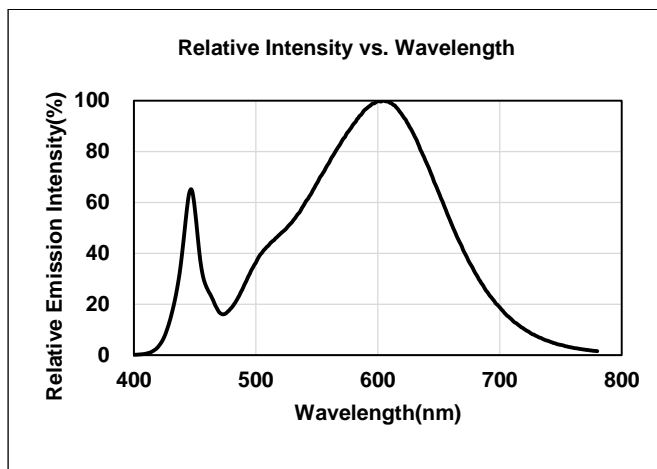

CCT: 3500 K (80 CRI)

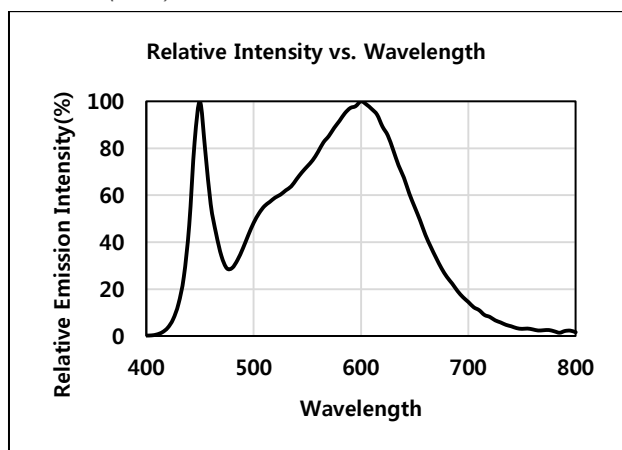

CCT: 4000 K (80 CRI)

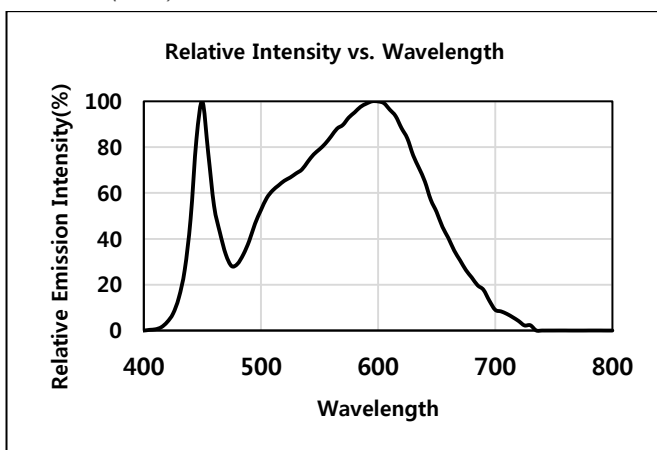

CCT: 5000 K (80 CRI)

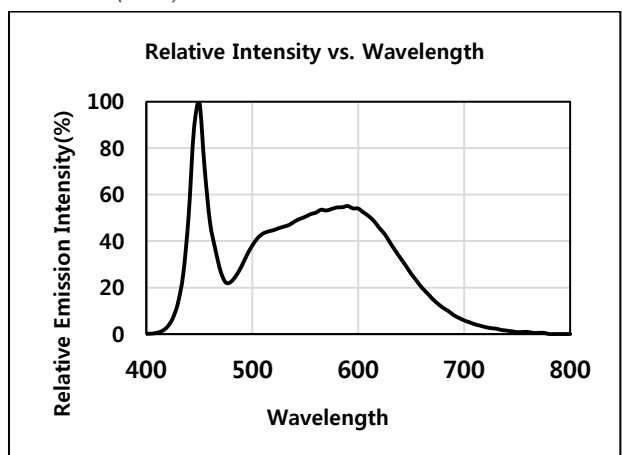

CCT: 5700 K (80 CRI)

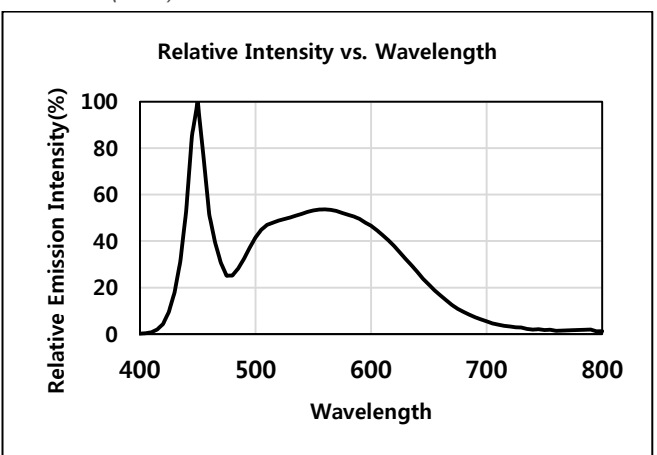

CCT: 6500 K (80 CRI)

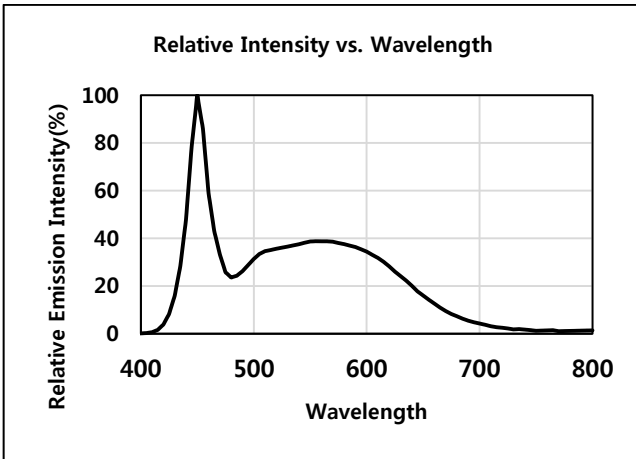

### b) Forward Current Characteristics ( $T_j = 85^\circ\text{C}$ )

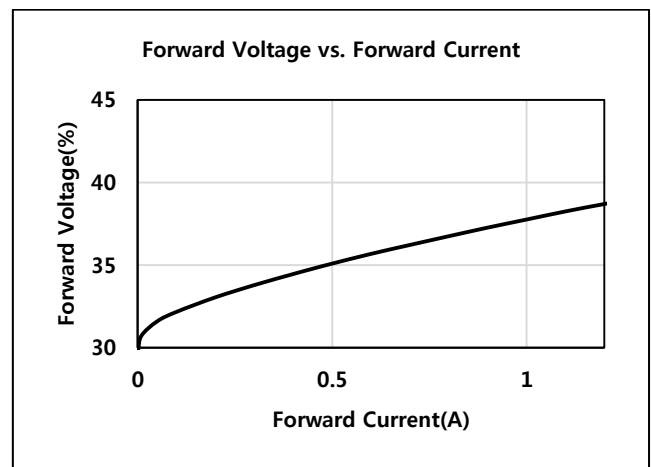
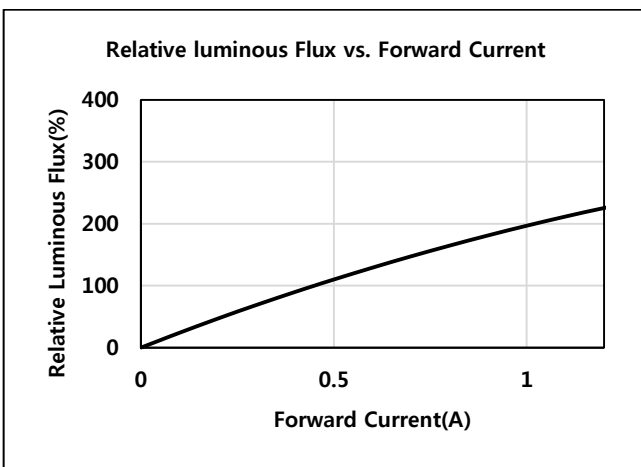

### C) Temperature Characteristics ( $I_f = 450\text{mA}$ )

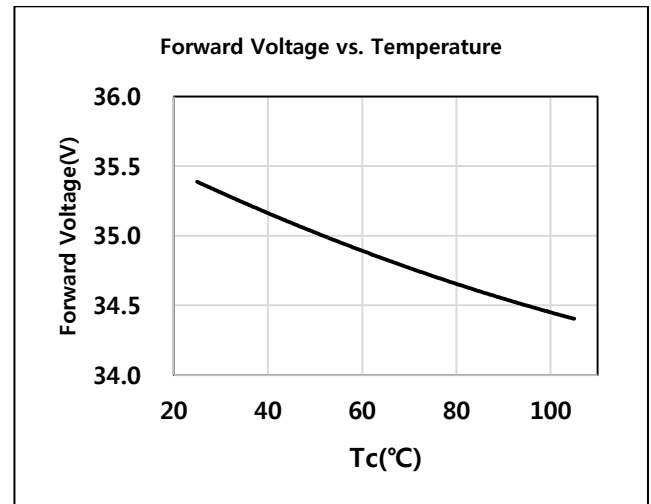
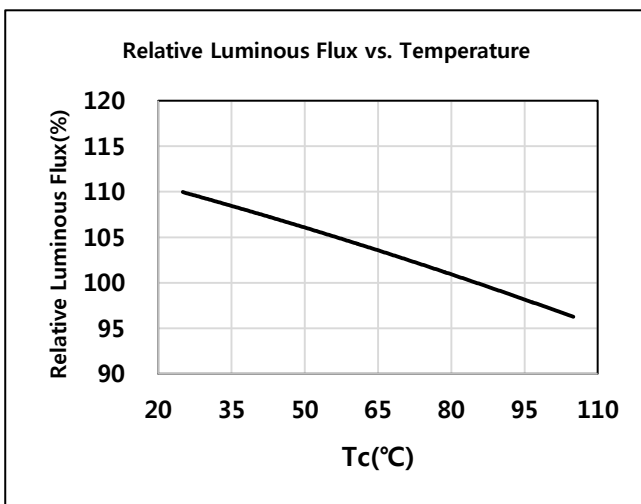

d) Color Shift Characteristics ( $T_J = 85\text{ }^\circ\text{C}$ ,  $I_F = 450\text{mA}$ , CRI80+)

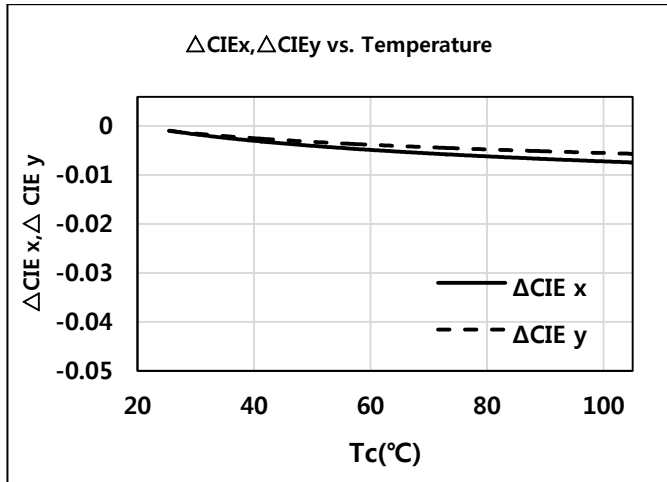
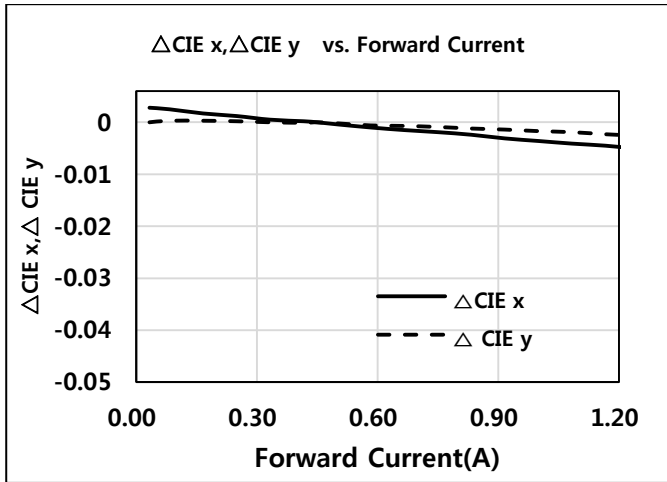

e) Beam Angle Characteristics ( $I_F = 450\text{ mA}$ ,  $T_J = 85\text{ }^\circ\text{C}$ )

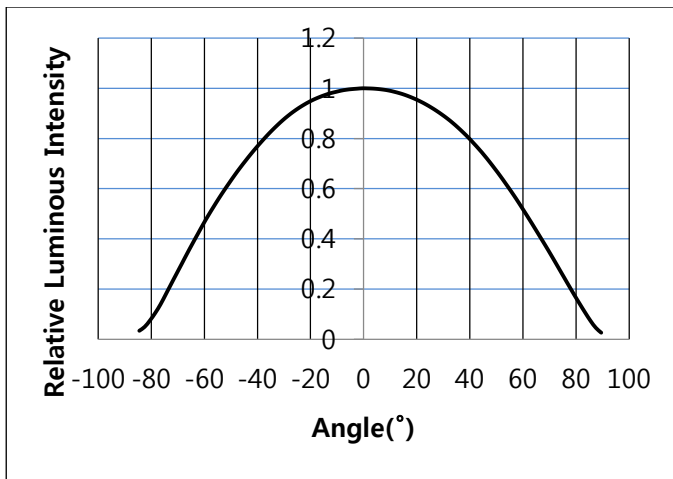

f) Derating Characteristics

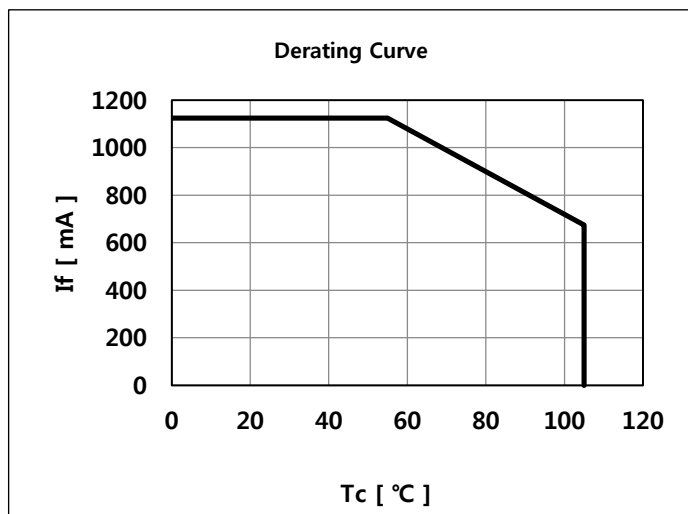

4. Outline Drawing & Dimension

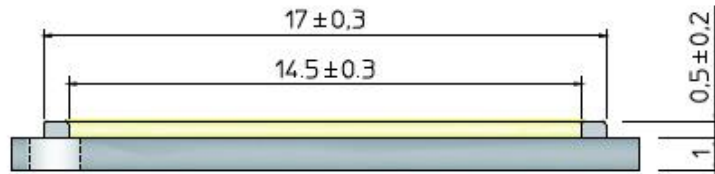
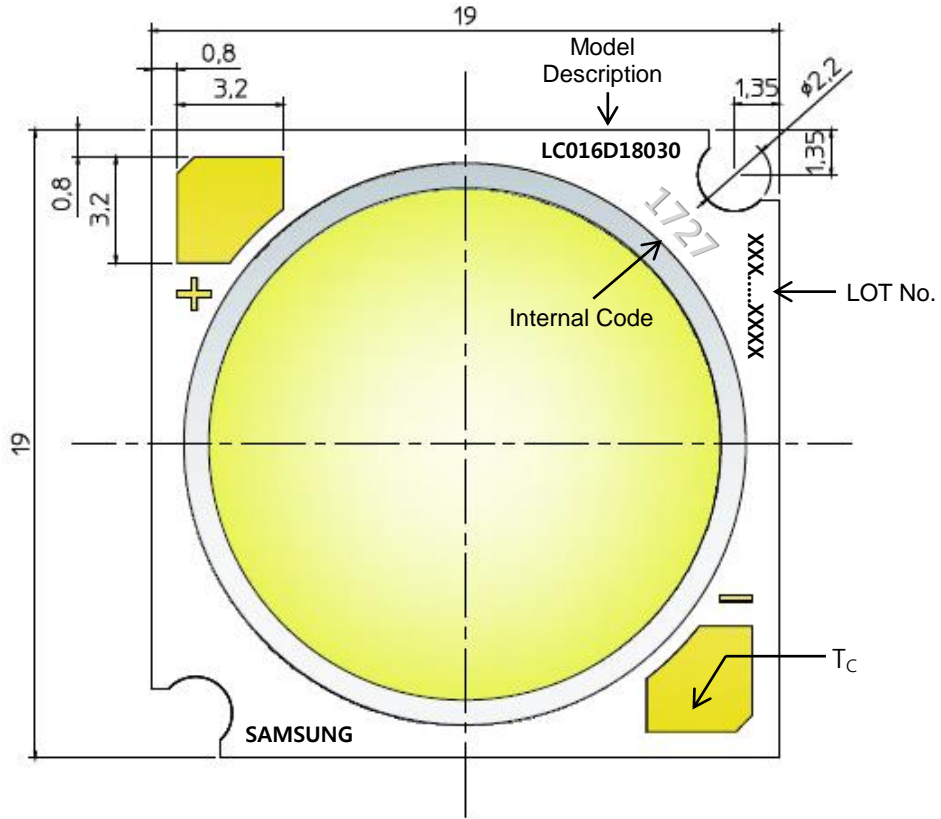

- 1. Unit: mm
- 2. Tolerance: ± 0.3 mm

Item	Dimension	Tolerance	Unit
Length	19.0	±0.15	mm
Width	19.0	±0.15	mm
Height	1.50	±0.30	mm
Light Emitting Surface (LES) Diameter	14.5	±0.30	mm

Note: Denoted product information above is only an example  
 ( LC016D18030 : LC016D, CRI80+, 3000K )

## 5. Reliability Test Items & Conditions

### a) Test Items

Test Item	Test Condition	Test Hour / Cycle
High Temperature Humidity Life Test	60 °C, 90 % RH,, DC Derating, $I_F$	1000 h
High Temperature Life Test	85 °C, DC Derating, $I_F$	1000 h
Low Temperature Life Test	-40 °C, DC , $I_F = 810$ mA	1000 h
Pulsed Operating Life Test	55 °C, Pulse width 100 $\mu$ s, duty cycle 3 %	1000 h
High Temperature Storage	120 °C	1000 h
Low Temperature Storage	-40 °C	1000 h
Temperature Humidity Storage	60 °C, 90% RH	1000h
Temperature Cycle On/Off Test	-40 °C / 85 °C each 20 min, 30 min transfer power on/off each 5 min, DC Derating, $I_F = \text{max}$	100 cycles
ESD (HBM)	R <sub>1</sub> : 10 M $\Omega$ R <sub>2</sub> : 1.5 k $\Omega$ C: 100 pF V: $\pm 2$ kV	5 times
ESD (MM)	R <sub>1</sub> : 10 M $\Omega$ R <sub>2</sub> : 0 k $\Omega$ C: 200 pF V: $\pm 0.2$ kV	5 times
Vibration Test	20 ~ 80 Hz (displacement: 0.06 inch, max. 20 g) 80 ~ 2 kHz (max. 20 g) min. frequency $\leftrightarrow$ max. frequency 4 min transfer	4 times
Mechanical Shock Test	1500 g, 0.5 ms each of the 6 surfaces (3 axis x 2 sides)	5 times
Sulfur Resistance	25 °C, 75%, H <sub>2</sub> S 15 ppm	504h

### b) Criteria for Judging the Damage

Item	Symbol	Test Condition ( $T_c = 25$ °C)	Limit	
			Min.	Max.
Forward Voltage	$V_F$	$I_F = 450$ mA	L.S.L. * 0.9	U.S.L. * 1.1
Luminous Flux	$\Phi_v$	$I_F = 450$ mA	L.S.L * 0.7	U.S.L * 1.3

## 6. Label Structure

## a) Label Structure

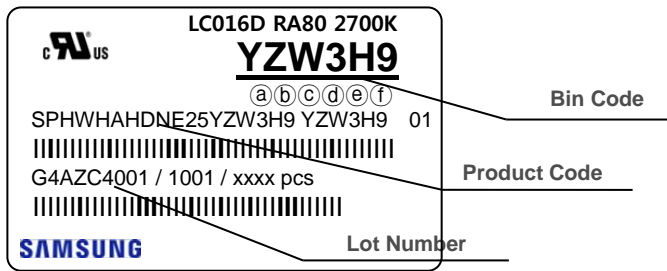

Note: Denoted bin code and product code above is only an example (see description on page 5)

Bin Code:

- ⒶⒷ: Forward Voltage bin (refer to page 11)
- ⒸⒹ: Chromaticity bin (refer to page 9-10)
- ⒺⒻ: Luminous Flux bin (refer to page 6)

## b) Lot Number

The lot number is composed of the following characters:

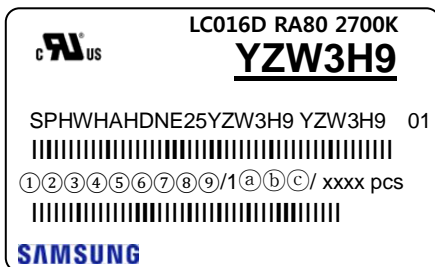

① ③④⑤⑥⑦⑧⑨ / 1ⒶⒷⒸ / xxxx pcs

- ① : Production site (S: Giheung, Korea, G: Tianjin, China)
- ② : 4 (LED)
- ③ : Product state (A: Normal, B: Bulk, C: First Production, R: Reproduction, S: Sample)
- ④ : Year (Z: 2015, A: 2016, B: 2017...)
- ⑤ : Month (1~9, A, B, C)
- ⑥⑦⑧⑨ : Day (1~9, A, B~V)
- ⒶⒷⒸ : Product serial number (001 ~ 999)

## 6. Packing Structure

Packing material	Max. quantity in pcs of COB	Dimension(mm)			
		Length	Width	Height	Tolerance
<b>Tray</b>	20	160	180	10	1.0
<b>Aluminum Bag</b>	40(2 trays)	210	241		10
<b>Inner Box</b>	160	230	84	260	2
<b>Outer Box</b>	1600	476	445	272	5

### a) Packing Structure

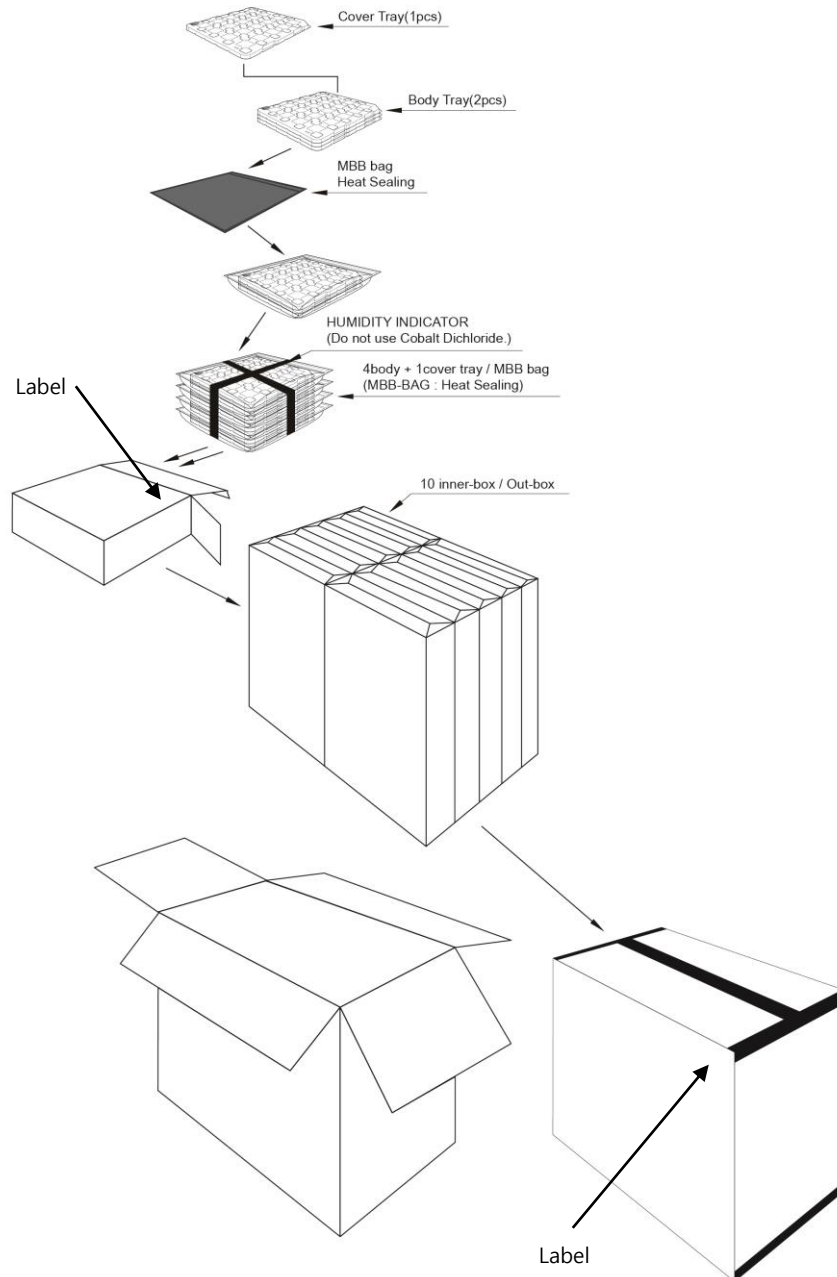

b) Tray

① Cover

② Body

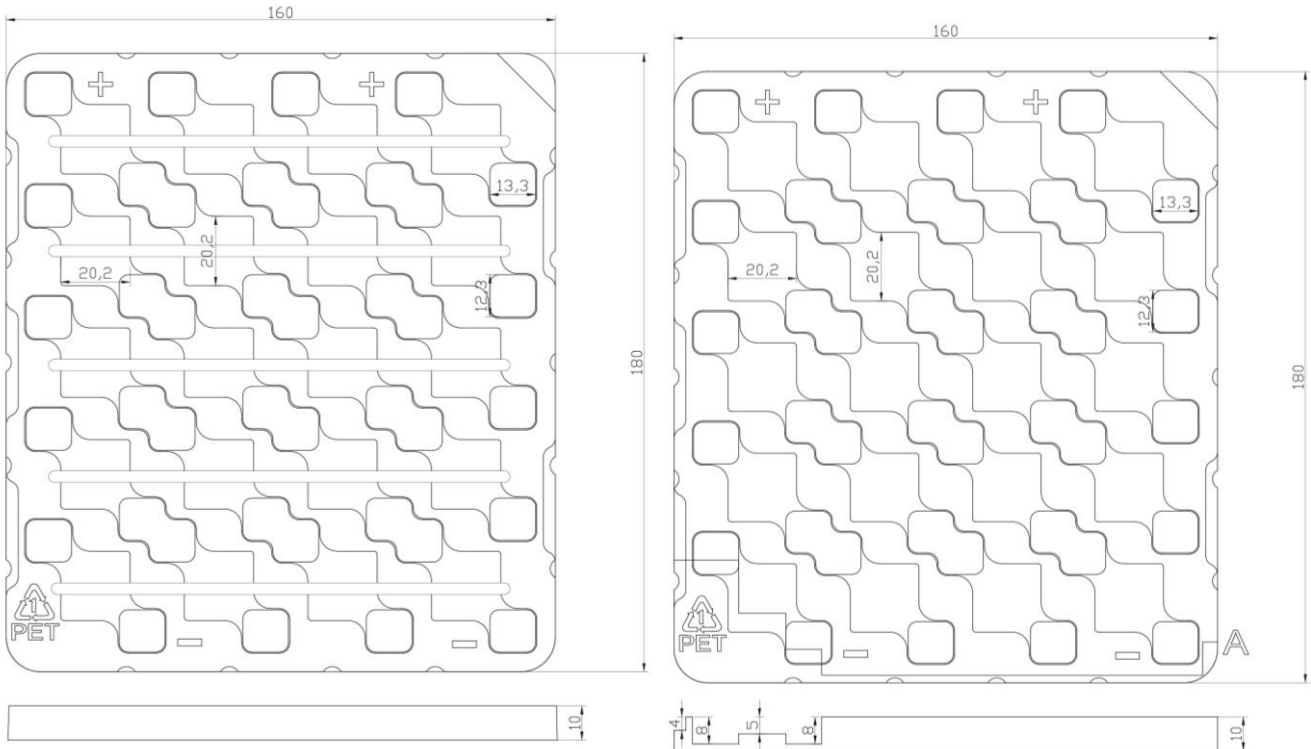

c) Aluminum Vinyl Packing Bag

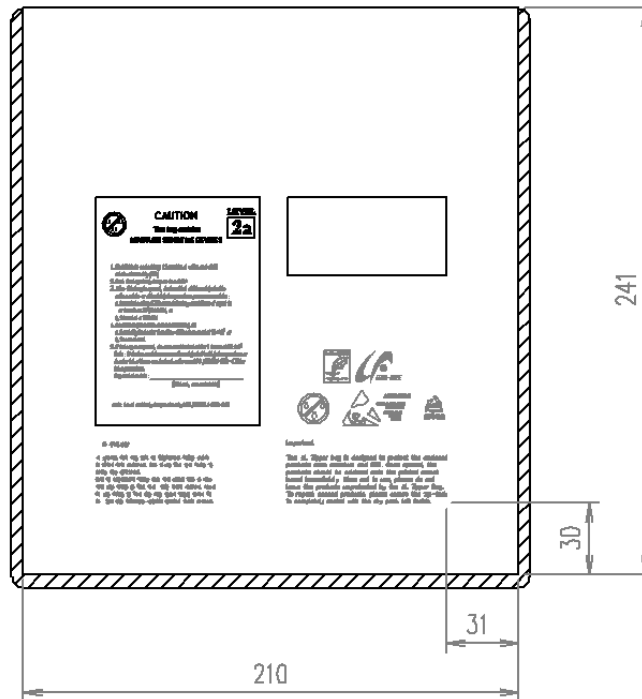



## 8. Precautions in Handling & Use

- 1) This device should not be used in any type of fluid such as water, oil, organic solvent, etc. When cleaning is required, IPA is recommended as the cleaning agent. Some solvent-based cleaning agent may damage the silicone resins used in the device.
- 2) LEDs must be stored in a clean environment. If the LEDs are to be stored for three months or more after being shipped from Samsung, they should be packed with a nitrogen-filled container (shelf life of sealed bags is 12 months at temperature 0~40 °C, 0~90 % RH).
- 3) After storage bag is opened, device subjected to soldering, solder reflow, or other high temperature processes must be:
  - a. Mounted within 672 hours (28 days) at an assembly line with a condition of no more than 30 °C / 60 % RH, or
  - b. Stored at <10 % RH
- 4) Repack unused products with anti-moisture packing, fold to close any opening and then store in a dry place.
- 5) Devices require baking before mounting, if humidity card reading is >60 % at 23 ± 5 °C.
- 6) Devices must be baked for 1 hour at 60 ± 5 °C, if baking is required.
- 7) The LEDs are sensitive to the static electricity and surge current. It is recommended to use a wrist band or anti-electrostatic glove when handling the LEDs. If voltage exceeding the absolute maximum rating is applied to LEDs, it may cause damage or even destruction to LED devices. Damaged LEDs may show some unusual characteristics such as increase in leakage current, lowered turn-on voltage, or abnormal lighting of LEDs at low current.
- 8) The thermal management is one of the most critical factors for the LED lighting system. Especially the LED junction temperature should not exceed the absolute maximum rating while operation of LED lighting system.  
For more information, please refer to Application Note 'Mechanical & Thermal Guide for COB'.
- 9) In case of driving LEDs around the minimum current level ( $I_{f\_min}$ ), chips might exhibit different brightness due to the variation in I-V characteristics of each one. This is normal and does not adversely affect the performance of product.
- 10) VOCs (Volatile Organic Compounds) can be generated from adhesives, flux, hardener or organic additives used in luminaires (fixtures). Transparent LED silicone encapsulant is permeable to those chemicals and they may lead to a discoloration of encapsulant when they exposed to heat or light. This phenomenon can cause a significant loss of light emitted (output) from the luminaires. In order to prevent these problems, we recommend users to know the physical properties of materials used in luminaires and they must be carefully selected.
- 11) The resin area is very sensitive, please do not handle, press, touch, rub, clean, or pick by with tweezers on it. Instead, please pick at the handling area as indicated below.

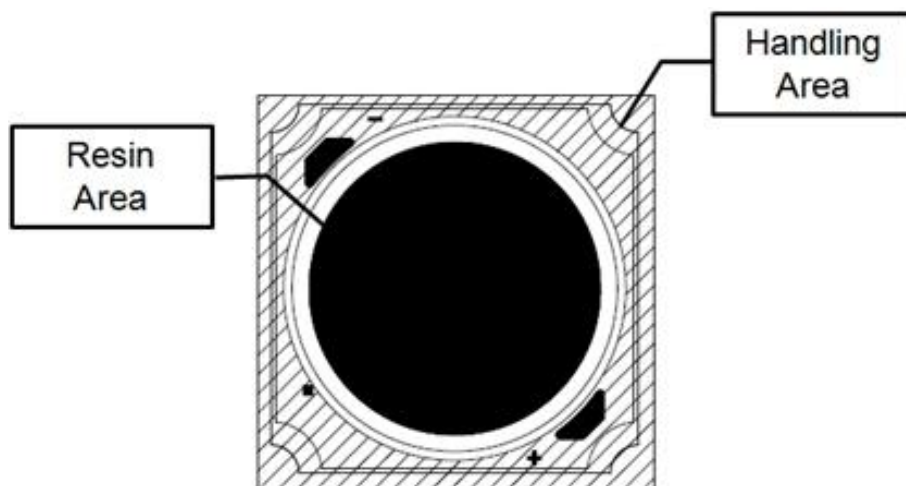

# Legal and additional information.

## [About Samsung Electronics Co., Ltd.](#)

Samsung Electronics Co., Ltd. inspires the world and shapes the future with transformative ideas and technologies, redefining the worlds of TVs, smartphones, wearable devices, tablets, cameras, digital appliances, printers, medical equipment, network systems and semiconductors.

We are also leading in the Internet of Things space through, among others, our Digital Health and Smart Home initiatives. We employ 307,000 people across 84 countries. To discover more, please visit our official website at [www.samsung.com](http://www.samsung.com) and our official blog at [global.samsungtomorrow.com](http://global.samsungtomorrow.com).

Copyright © 2015 Samsung Electronics Co., Ltd. All rights reserved.

Samsung is a registered trademark of Samsung Electronics Co., Ltd.

Specifications and designs are subject to change without notice. Non-metric weights and measurements are approximate. All data were deemed correct at time of creation. Samsung is not liable for errors or omissions. All brand, product, service names and logos are trademarks and/or registered trademarks of their respective owners and are hereby recognized and acknowledged.

Samsung Electronics Co., Ltd.  
95, Samsung 2-ro  
Giheung-gu  
Yongin-si, Gyeonggi-do, 446-711  
KOREA

[www.samsungled.com](http://www.samsungled.com)

**SAMSUNG**