

AIMB-276

**Intel® Core™ i7/i5/i3 LGA1151
Mini-ITX with HDMI2.0a/Dual
DP++/LVDS(or eDP), 2 x COM,
Dual LAN, SATAIII, 6 x USB3.1 &
4 x USB3.0, M.2 (B-key & E-key)**

Copyright

The documentation and the software included with this product are copyrighted 2019 by Advantech Co., Ltd. All rights are reserved. Advantech Co., Ltd. reserves the right to make improvements in the products described in this manual at any time without notice.

No part of this manual may be reproduced, copied, translated or transmitted in any form or by any means without the prior written permission of Advantech Co., Ltd. Information provided in this manual is intended to be accurate and reliable. However, Advantech Co., Ltd. assumes no responsibility for its use, nor for any infringements of the rights of third parties, which may result from its use.

Acknowledgements

IBM and PC are trademarks of International Business Machines Corporation.

Intel® Core™ i7/i5/i3, Pentium, Celeron® is trademark of Intel Corporation

All other product names or trademarks are properties of their respective owners.

A Message to the Customer

Advantech Customer Services

Each and every Advantech product is built to the most exacting specifications to ensure reliable performance in the harsh and demanding conditions typical of industrial environments. Whether your new Advantech equipment is destined for the laboratory or the factory floor, you can be assured that your product will provide the reliability and ease of operation for which the name Advantech has come to be known. Your satisfaction is our primary concern. Here is a guide to Advantech's customer services. To ensure you get the full benefit of our services, please follow the instructions below carefully.

Technical Support

We want you to get the maximum performance from your products. So if you run into technical difficulties, we are here to help. For the most frequently asked questions, you can easily find answers in your product documentation. These answers are normally a lot more detailed than the ones we can give over the phone.

So please consult this manual first. If you still cannot find the answer, gather all the information or questions that apply to your problem, and with the product close at hand, call your dealer. Our dealers are well trained and ready to give you the support you need to get the most from your Advantech products. In fact, most problems reported are minor and are able to be easily solved over the phone.

In addition, free technical support is available from Advantech engineers every business day. We are always ready to give advice on application requirements or specific information on the installation and operation of any of our products.

Declaration of Conformity

FCC Class B

This device complies with the requirements in part 15 of the FCC rules:

Operation is subject to the following two conditions:

- This device may not cause harmful interference
- This device must accept any interference received, including interference that may cause undesired operation.

This equipment has been tested and found to comply with the limits for a Class B digital device, pursuant to Part 15 of the FCC Rules. These limits are designed to provide reasonable protection against harmful interference when the equipment is operated in a commercial environment. This equipment generates, uses, and can radiate radio frequency energy and, if not installed and used in accordance with the instruction manual, may cause harmful interference to radio communications. Operation of this device in a residential area is likely to cause harmful interference in which case the user will be required to correct the interference at his/her own expense. The user is advised that any equipment changes or modifications not expressly approved by the party responsible for compliance would void the compliance to FCC regulations and therefore, the user's authority to operate the equipment.

Caution! *There is a danger of a new battery exploding if it is incorrectly installed. Do not attempt to recharge, force open, or heat the battery. Replace the battery only with the same or equivalent type recommended by the manufacturer. Discard used batteries according to the manufacturer's instructions.*



CPU Compatibility

Processor_Number	Frequency Speed	Cache	Lithography
I7-8700	3.2 GHz	12 MB	14nm
I7-8700T	2.4 GHz	12 MB	14nm
I5-8500	3.0 GHz	9 MB	14nm
I5-8500T	2.1 GHz	9 MB	14nm
I3-8100	3.6 GHz	6 MB	14nm
I3-8100T	3.1 GHz	6 MB	14nm
Intel Pentium® Processor G5400	3.7 GHz	4 MB	14nm
Intel Pentium® Processor G5400T	3.1 GHz	4 MB	14nm
Intel Celeron® Processor G4900	3.1 GHz	2 MB	14nm
Intel Celeron® Processor G4900T	2.9 GHz	2 MB	14nm

Memory Compatibility

Category	Speed	Capacity	Vendor	Module_PN	Chip_PN	ADVANTECH P/N
DDR4	2666	8GB	Advantech	SQR-SD4N8G2K6SNEEB	SEC 737 K4A4G08 5WE BCTD	SQR-SD4N8G2K6SNEEB
DDR4	2666	4GB	Advantech	SQR-SD4N4G2K6SNEEB	SEC 807 K4A4G08 5WE BCTD	SQR-SD4N4G2K6SNEEB
DDR4	2400	16GB	Advantech	SQR-SD4M16G2K4SNBB	SEC 749 K4A8G08 5WB BCRC	SQR-SD4M16G2K4SNBB
DDR4	2400	4GB	Advantech	SQR-SD4M4G2K4SNEEB	SEC 749 K4A4G08 5WE BCRC	SQR-SD4M4G2K4SNEEB
DDR4	2133	16GB	Advantech	AQD-SD4U16N21-SE	SEC 546 K4A8G08 5WB BCPB	AQD-SD4U16N21-SE
DDR4	2133	8GB	Advantech	AQD-SD4U8GN21-SG	SEC 552 BCPB K4A4G08 5WD	AQD-SD4U8GN21-SG
DDR4	2400	8GB	Advantech	SQR-SD4N-8G2K4HBC	H5AN8G8 NAFR UHC 643V	SQR-SD4N-8G2K4HBC
DDR4	2400	16GB	Advantech	SQR-SD4N-16G2K4HBC	H5AN8G8 NAFR UHC 643V	SQR-SD4N-16G2K4HBC
DDR4	2400	16GB	Advantech	AQD-SD4U16N24-HE	H5AN8G8 NAFR UHC	AQD-SD4U16N24-HE

Ordering Information

P/N	Chipset	DP	LVDS/ eDP	HDMI	GbE LAN	COM	M.2 B key	M.2 E key	SATAIII	USB3.1/ 3.0	TPM	AMP	PCIex 16	Power
AIMB-276G2-00A1E	Q370	2	1 / (1)	2	2	2	1, Type: 2242 & 3042	1, Type: 2230	3	5+(1)/4	(1)	(1)	1	12- 24V (via phoe- nix con- nector)
AIMB-276VG-01A1E	Q370	2	1 / (1)	2	2	2	1, Type: 2242 & 3042	1, Type: 2230	3	5+(1)/4	(1)	(1)	1	12V (via ATX12 V1)

*) BOM options available on MP version

Product Warranty (2 years)

Advantech warrants to you, the original purchaser, that each of its products will be free from defects in materials and workmanship for two years from the date of purchase.

This warranty does not apply to any products which have been repaired or altered by persons other than repair personnel authorized by Advantech, or which have been subject to misuse, abuse, accident or improper installation. Advantech assumes no liability under the terms of this warranty as a consequence of such events.

Because of Advantech's high quality-control standards and rigorous testing, most of our customers never need to use our repair service. If an Advantech product is defective, it will be repaired or replaced at no charge during the warranty period. For out-of-warranty repairs, you will be billed according to the cost of replacement materials, service time and freight. Please consult your dealer for more details.

If you think you have a defective product, follow these steps:

1. Collect all the information about the problem encountered. (For example, CPU speed, Advantech products used, other hardware and software used, etc.) Note anything abnormal and list any onscreen messages you get when the problem occurs.
2. Call your dealer and describe the problem. Please have your manual, product, and any helpful information readily available.
3. If your product is diagnosed as defective, obtain an RMA (return merchandise authorization) number from your dealer. This allows us to process your return more quickly.
4. Carefully pack the defective product, a fully-completed Repair and Replacement Order Card and a photocopy proof of purchase date (such as your sales receipt) in a shippable container. A product returned without proof of the purchase date is not eligible for warranty service.
5. Write the RMA number visibly on the outside of the package and ship it prepaid to your dealer.

Initial Inspection

Before you begin installing your motherboard, please make sure that the following materials have been shipped:

- 1 x AIMB-276 Intel Core™ i7/i5/i3 LGA1151 Mini-ITX motherboard
- 1 x SATA HDD cable
- 1 x SATA Power cable
- 1 x Serial port cable
- 1 x I/O port bracket
- 1 x Startup manual
- 1 x Warranty card

If any of these items are missing or damaged, contact your distributor or sales representative immediately. We have carefully inspected the AIMB-276 mechanically and electrically before shipment. It should be free of marks and scratches and in perfect working order upon receipt. As you unpack the AIMB-276, check it for signs of shipping damage. (For example, damaged box, scratches, dents, etc.) If it is damaged or it fails to meet the specifications, notify our service department or your local sales representative immediately. Also notify the carrier. Retain the shipping carton and packing material for inspection by the carrier. After inspection, we will make arrangements to repair or replace the unit.

Contents

Chapter 1 General Information1

1.1	Introduction	2
1.2	Features	2
1.3	Specifications	2
1.3.1	System	2
1.3.2	Memory	2
1.3.3	Input/Output	2
1.3.4	Graphics.....	3
1.3.5	Ethernet LAN	3
1.3.6	Industrial features	3
1.3.7	Mechanical and environmental specifications.....	3
1.4	Jumpers and Connectors	4
	Table 1.1: Connector/Header List.....	4
	Table 1.2: Jumper Setting List.....	5
1.5	Board layout: Jumper and Connector Locations	9
	Figure 1.1 Jumper and Connector Location (Top Side).....	9
	Figure 1.2 Jumper and Connector Location (Bottom Side)	10
1.6	AIMB-276 Board Diagram	11
	Figure 1.3 AIMB-276 Board Diagram	11
1.7	Safety Precautions	12
1.8	Jumper Settings	12
1.8.1	How to Set Jumpers.....	12
1.8.2	CMOS Clear (CMOS1)	13
	Table 1.3: CMOS1	13
1.8.3	Power Switch/HDD LED/SMBUS/Speaker Pin Header (JFP1) ..	13
	Table 1.4: Power Switch/HDD LED/SMBUS/Speaker Pin Header (JFP1).....	13
1.8.4	Power LED and Keyboard Lock Pin Header (JFP2).....	13
	Table 1.5: Power LED and Keyboard Lock Pin Header (JFP2). 13	
1.8.5	Watchdog Timer Output and OBS Beep (JWDT1+JOBS1).....	14
	Table 1.6: Watchdog Timer Output and OBS Beep (JWDT1+JOBS1).....	14
1.8.6	ATX/AT Mode Selection (PSON1).....	14
	Table 1.7: ATX/AT Mode Selection (PSON1).....	14
1.8.7	LVDS Panel Voltage Selection (JLVDS1).....	15
	Table 1.8: LVDS Panel Voltage Selection (JLVDS1)	15
1.8.8	COM2 RI# Pin RI#/5V/12V Select (JSETCOM2_V1)	15
	Table 1.9: COM2 RI# Pin RI#/5V/12V Select (JSETCOM2_V1)15	
1.9	System Memory	15
1.10	Memory Installation Procedures.....	16
1.11	Cache Memory.....	16
1.12	Processor Installation.....	16

Chapter 2 Connecting Peripherals17

2.1	Introduction	18
2.2	USB Ports (LAN1_USB12/LAN2_USB34/USB56/USB78/USB910).....	18
	Table 2.1: LAN LED Indicator.....	19
2.3	DisplayPort1/2 (DP12) / High-Definition Multimedia Interface connector (HDMI1).....	19
2.4	Serial Ports (COM1~COM2)	20
2.5	CPU Fan Connector (CPU_FAN1).....	21
2.6	System FAN Connector (SYSFAN1/2).....	22
2.7	Power Switch/HDD LED/SMBUS/Speaker Pin Header (JFP1) & Power	

	LED and Keyboard Lock Pin Header (JFP2)	23
	2.7.1 ATX soft power switch (JFP1/PWR_SW)	23
	2.7.2 Reset (JFP1/RESET).....	23
	2.7.3 HDD LED (JFP1/HDDLED)	23
	2.7.4 External speaker (JFP1/SPEAKER).....	23
2.8	DC Input Phoenix Connector (DCIN1)	24
2.9	SATA Signal & Power Connector (SATA1~SATA3 / SATA_PWR1~2) ..	25
2.10	HD Analog Audio Interface (AUDIO1, FPAUD1)	26
2.11	PCI-E x16 Slot (PCIEX16_1)	27
2.12	Low-voltage differential signaling interface/Embedded display port (LVDS_EDP1).....	28
2.13	LVDS Backlight Inverter Power Connector (INV1).....	29
2.14	NGFF M.2 B-Key & E-Key connector (M2B1 & M2E1).....	30
2.15	Audio Amplifier Output Connector (AMP1), BOM optional	32
2.16	General Purpose I/O Pin Header (GPIO1).....	33
2.17	SPI BIOS Flash Socket (SPI1).....	34
2.18	SPI Programming Pin Header (SPI_CN1)	35
2.19	Low Pin Count Header (LPC1)	36
2.20	Case-Open Detect Connector (JCASE1).....	37
2.21	CMOS battery connector (BAT1).....	38
2.22	CPU Socket (CPU1)	39
2.23	DDR4 SO-DIMM Socket (DIMMA1, DIMMB1).....	40
Chapter 3	BIOS Operation	41
3.1	Introduction	42
3.2	BIOS Setup	42
	3.2.1 Main Menu	43
	3.2.2 Advanced BIOS Features	43
3.3	Chipset Configuration Setting	57
	3.3.1 System Agent (SA) Configuration	58
	3.3.2 PCH-IO Configuration.....	62
3.4	Security Setting.....	67
3.5	Boot Setting	68
3.6	Save & Exit Configuration	69
Chapter 4	Software Introduction & Service	71
4.1	Introduction	72
4.2	Value-Added Software Services	72
	4.2.1 Software API.....	72
	4.2.2 Software Utility.....	74
Chapter 5	Chipset Software Installation Utility	75
5.1	Before You Begin	76
5.2	Introduction	76
5.3	Windows 10 Driver Setup	77
Chapter 6	VGA Setup	79
6.1	Introduction	80
6.2	Windows 10	80
Chapter 7	LAN Configuration	81

7.1	Introduction	82
7.2	Features	82
7.3	Installation	82
7.4	Windows 10 Driver Setup.....	83

Appendix A I/O Pin Assignments.....85

A.1	Direct Current input connector (DCIN1)	86
A.2	DisplayPort1/2 (DP12)	86
A.3	High-Definition Multimedia Interface connector (HDMI1)	87
A.4	Universal Serial Bus Port 3.1 Gen1 #7/ #8 (USB78).....	87
A.5	Universal Serial Bus Port 3.1 Gen2 #1/ #2 (USB12).....	88
A.6	RJ45 #1(LAN1)	88
A.7	Universal Serial Bus Port 3.1 Gen2 #3/ #4 (USB34).....	89
A.8	RJ45 #2(LAN2)	89
A.9	Universal Serial Bus Port 3.1 Gen2 #6 (Type-C) (USB6)	89
A.10	Universal Serial Bus Port 3.1 Gen2 #5 (USB5).....	90
A.11	HD Audio Interface (Analog) (AUDIO1)	90
A.12	Amplifier connector (AMP1)	91
A.13	Front panel audio header (FPAUD1)	91
A.14	CMOS Mode selection (JCMOS1)	91
A.15	PCI Express x16 slot (PCIEX16_1).....	92
A.16	CMOS battery connector (BAT1)	94
A.17	Case Open connector (JCASEOP_SW1)	94
A.18	Case Open connector (JCASE1)	95
A.19	NGFF M.2 B-Key connector for 2242/3042 module (M2B1).....	95
A.20	Universal Serial Bus Port 3.1 Gen1 #9/ #10 box header (USB910).....	96
A.21	COM1 RI# selection pin header (JSETCOM1_V1).....	97
A.22	Serial ATA interface connector #1~#3 (SATA1~SATA3).....	97
A.23	COM2 pin header (S1.27MM) (COM2)	98
A.24	EDP/LVDS Backlight inverter power connector (INV1).....	98
A.25	COM1 pin header (S1.27MM) (COM1)	99
A.26	Low pin count interface connector (LPC1).....	99
A.27	Subscriber Identity Module connector (SIM1).....	100
A.28	LVDS VESA, JEIDA format selection pin header (JLVDS_VCON1).....	100
A.29	Low-voltage differential signaling interface/Embedded displayport (LVDS_EDP1).....	101
A.30	Voltage selection for JLVDS connector (JLVDS1).....	102
A.31	System Fan #1 connector /System Fan #2 connector (SYSFAN1/2) ...	102
A.32	Power LED and keyboard lock pin header (JFP2).....	103
A.33	Watchdog timer output and OBS beep (JWDT1+JOBS1).....	103
A.34	CPU FAN connector (CPUFAN1)	103
A.35	8-bits General Purpose I/O pin header(S1.27MM) (GPIO1)	104
A.36	PWRBTN#/ RESET#/HDD LED/ Serial bus from HW monitor IC/Internal Buzzer / External Speaker header (JFP1)	104
A.37	SPI BIOS flash socket (SPI1).....	105
A.38	Serial ATA interface power connector (SATA_PWR1/2)	105
A.39	AT/ATX Mode selection (PSON1).....	106
A.40	ATX supported 3-pin header on board (ATX_5VSB1)	106
A.41	NGFF M.2 E-Key connector for 2230 module (M2E1)	107

Chapter 1

General Information

1.1 Introduction

AIMB-276 is designed with the Intel® Q370 PCH for industrial applications that require both performance computing and enhanced power management capabilities. The motherboard supports Intel desktop Core i7/i5/i3/Pentium/Celeron processor up to 12 MB L3 cache and 2 DDR4 2666MHz SO-DIMM, up to 32 GB. A rich I/O connectivity of 2 serial ports, 10 USB, dual GbE LAN, 3 SATA, 2 NGFF (M.2_B Key & M.2_E Key) Connector.

1.2 Features

- **Rich I/O connectivity:** 2 serial ports, 10 USB 3.1, 3 SATA, 2 M.2 NGFF connector, Dual GbE LAN and 1 PCIe x16
- **Standard Mini-ITX form factor with industrial feature:** The AIMB-276 is a full-featured Mini-ITX motherboard with balanced expandability and performance
- **Wide selection of storage devices:** SATA HDD, M.2 (E key), M.2 (B key), customers benefit from the flexibility of using the most suitable storage device for larger capacity
- **Optimized integrated graphic solution:** With Intel® Graphics Flexible, it supports versatile display options and 32/64 bit 3D graphics engine

1.3 Specifications

1.3.1 System

- **CPU:** LGA1151 Intel desktop Core i7/i5/i3/Pentium/Celeron processors compliant
- **BIOS:** AMI EFI 256 Mbit SPI BIOS
- **System chipset:** Intel® Q370
- **SATA hard disk drive interface:**
 - Three on-board SATA connector with data transmission rate up to 600 MB

1.3.2 Memory

- **RAM:** 2 x 260-pins SODIMM socket support dual channel DDR4 2666MHz SDRAM, up to 32GB Max.

1.3.3 Input/Output

- **PCI bus:** 1 PCIe x16 slot
- **Serial ports:** Two serial ports, 1 x RS-232 & 1 x RS-232/422/485
- **USB port:** Supports up to ten USB ports with transmission rate up to 10 Gbit/s (1250 MB/s)
- **GPIO connector:** 8-bit general purpose Input/Output

1.3.4 Graphics

- **Controller:** Intel® HD graphics
- **Display memory:** 1 GB maximum shared memory with 2GB and above system memory installed
- **LVDS:** Supports LVDS up to resolution 1920 x 1200
- **HDMI:** Supports HDMI up to resolution 4096x2160 @ 60Hz
- **Displayport1.2:** Supports Display port up to resolution 4096 x 2304 @ 60Hz
- **eDP:** Supports up to resolution 4096 x 2160 @ 60Hz (BOM optional)

1.3.5 Ethernet LAN

- Supports dual 10/100/1000 Mbps Ethernet port (s) via PCI Express x1 bus which provides 500 MB/s data transmission rate
- **Controller:** LAN1: Intel i219LM; LAN2: Intel i211AT

1.3.6 Industrial features

- **Watchdog timer:** Can generate a system reset. The watchdog timer is programmable, with each unit equal to one second or one minute (255 levels)

1.3.7 Mechanical and environmental specifications

- **Operating temperature:** 0 ~ 60° C (32 ~ 140° F, Depending on CPU)
- **Storage temperature:** -40 ~ 85° C (-40 ~ 185° F)
- **Humidity:** 5 ~ 95% non-condensing
- **Power supply voltage:** 12~24V DC Input
- **Board size:** 170 mm x 170 mm (6.69" x 6.69")
- **Board weight:** 0.365 kg

1.4 Jumpers and Connectors

Connectors on the AIMB-276 motherboard link it to external devices such as hard disk drives and a keyboard. In addition, the board has a number of jumpers used to configure your system for your application.

The tables below list the function of each of the board jumpers and connectors. Later sections in this chapter give instructions on setting jumpers. Chapter 2 gives instructions for connecting external devices to your motherboard.

Table 1.1: Connector/Header List

	Description	Part Reference
1	Direct Current input connector	DCIN1
2	DisplayPort1/2	DP12
3	High-Definition Multimedia Interface connector	HDMI1
4	Universal Serial Bus Port 3.1 Gen1 #7/ #8	USB78
5	Universal Serial Bus Port 3.1 Gen2 #1/ #2	USB12
6	RJ45 #1	LAN1
7	Universal Serial Bus Port 3.1 Gen2 #3/ #4	USB34
8	RJ45 #2	LAN2
9	Universal Serial Bus Port 3.1 Gen2 #6 (Type-C)	USB6
10	Universal Serial Bus Port 3.1 Gen2 #5	USB5
11	HD Audio Interface (Analog)	AUDIO1
12	Amplifier connector	AMP1
13	Front panel audio header	FPAUD1
14	CMOS Mode selection	JCMOS1
15	PCI Express x16 slot	PCIEX16_1
16	Platform Controller Hub	PCH1
17	CMOS battery connector	BAT1
18	Case Open selection pin header	JCASEOP_SW1
19	Case Open connector	JCASE1
20	NGFF M.2 B-Key connector for 2242/3042 module	M2B1
21	Universal Serial Bus Port 3.1 Gen1 #9/ #10 box header	USB910
22	COM1 RI# selection pin header	JSETCOM1_V1
23	Serial ATA interface connector #1~#3	SATA1~SATA3
24	COM2 pin header (S1.27MM)	COM2
25	EDP/LVDS Backlight inverter power connector	INV1
26	COM1 pin header (S1.27MM)	COM1
27	Low pin count interface connector	LPC1
28	Subscriber Identity Module connector	SIM1
29	LVDS VESA, JEIDA format selection pin header	JLVDS_VCON1
30	Low-Voltage Differential Signaling Interface/ Embedded DisplayPort	LVDS_EDP1
31	Voltage selection for JLVDS connector	JLVDS1

Table 1.1: Connector/Header List

32	System Fan #1 connector/System Fan #2 connector	SYSFAN1/2
33	Power LED and keyboard lock pin header	JFP2
34	Watchdog timer output and OBS beep	JWDT1+JOBS1
35	CPU FAN connector	CPUFAN1
36	8-bits General Purpose I/O pin header(S1.27MM)	GPIO1
37	PWRBTN#/ RESET#/HDD LED/Serial bus from HW monitor IC/Internal Buzzer / External Speaker header	JFP1
38	CPU SCOKET LGA1151 H4	CPU1
39	DDR4 SO-DIMM socket A1/DDR4 SO-DIMM socket B1	DIMMA1/ DIMMB1
40	SPI BIOS flash socket	SPI1
41	SPI Pin Header	SPI_CN1
42	Serial ATA interface power connector	SATA_PWR1/2
43	AT/ATX Mode selection	PSOEN1
44	ATX supported 3-pin header on board	ATX_5VSB1
45	NGFF M.2 E-Key connector for 2230 module	M2E1



Table 1.2: Jumper Setting List

	Description	Part Reference
1	Voltage selection for LVDS1/EDP1 connector	JLVDS1
2	RTC / CMOS clear	JCMOS1
3	PWRBTN#/ RESET#/HDD LED/ Serial bus from HW monitor IC/Internal Buzzer / External Speaker header	JFP1
4	Watchdog timer output and OBS beep	JWDT1+JOBS1
5	AT / ATX Mode selection	PSOEN1
6	Case open selection pin header	JCASEOP_SW1
7	COM1_RI# Pin selection pin header	JSETCOM1_V1
8	LVDS VESA, JEIDA format selection pin header	JLVDS_VCON1

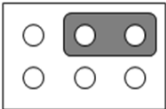
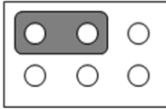
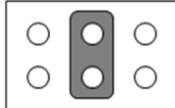
1. Voltage selection for LVDS1/EDP1 connector (JLVDS1)

Function	Jumper Setting
Jumper position for +3.3V (Default)	<p>2 4 6</p> 
Jumper position for +5V	<p>1 3 5</p> <p>2 4 6</p> 
Jumper position for +12V	<p>1 3 5</p> <p>2 4 6</p>  <p>1 3 5</p>

2. CMOS clear (JCMOS1)

Function	Jumper Setting
Keep CMOS Data (Default)	<p>1 2 3</p> 
Clear CMOS Data	<p>1 2 3</p> 

3. PWRBTN#/ RESET#/HDD LED/ Serial bus from HW monitor IC/Internal Buzzer / External Speaker header (JFP1)

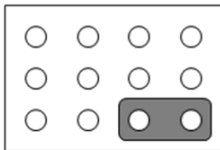
Function	Jumper Setting
Internal Buzzer (Default)	<p>3 12</p>  <p>1 7 10</p>

4. Watchdog timer output and OBS beep (JWDT1+ JOBS1)

Function	Jumper Setting
----------	----------------

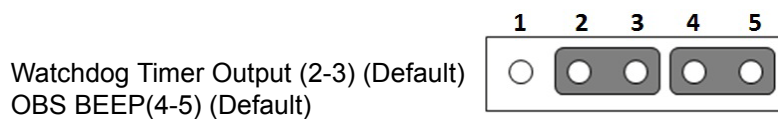

5. AT / ATX Mode selection (PSON1)

Function	Jumper Setting
----------	----------------

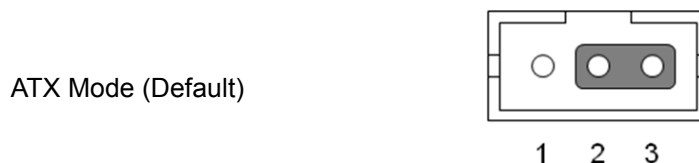

6. Case open selection pin header (JCASEOP_SW1)

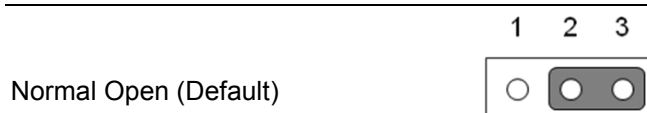

Function	Jumper Setting
----------	----------------

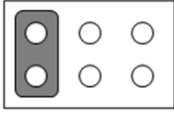
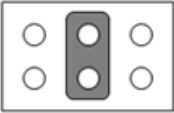
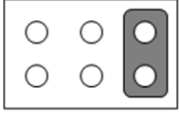

7. COM1_RI# Pin RI# / 5V / 12V selection (JSETCOM1_V1)

Function	Jumper Setting
Jumper position for RI# (Default)	<div style="text-align: center;"> <p>2 4 6</p>  <p>1 3 5</p> </div>
Jumper position for +5V	<div style="text-align: center;"> <p>2 4 6</p>  <p>1 3 5</p> </div>
Jumper position for +12V	<div style="text-align: center;"> <p>2 4 6</p>  <p>1 3 5</p> </div>

8. LVDS VESA, JEIDA format selection pin header (JLVDS_VCON1)

Function	Jumper Setting
JEIDA mode (HI=+3.3V)	<div style="text-align: center;"> <p>1 2 3</p>  </div>
VESA mode (Low=0V) (Default)	<div style="text-align: center;"> <p>1 2 3</p>  </div>

1.5 Board layout: Jumper and Connector Locations

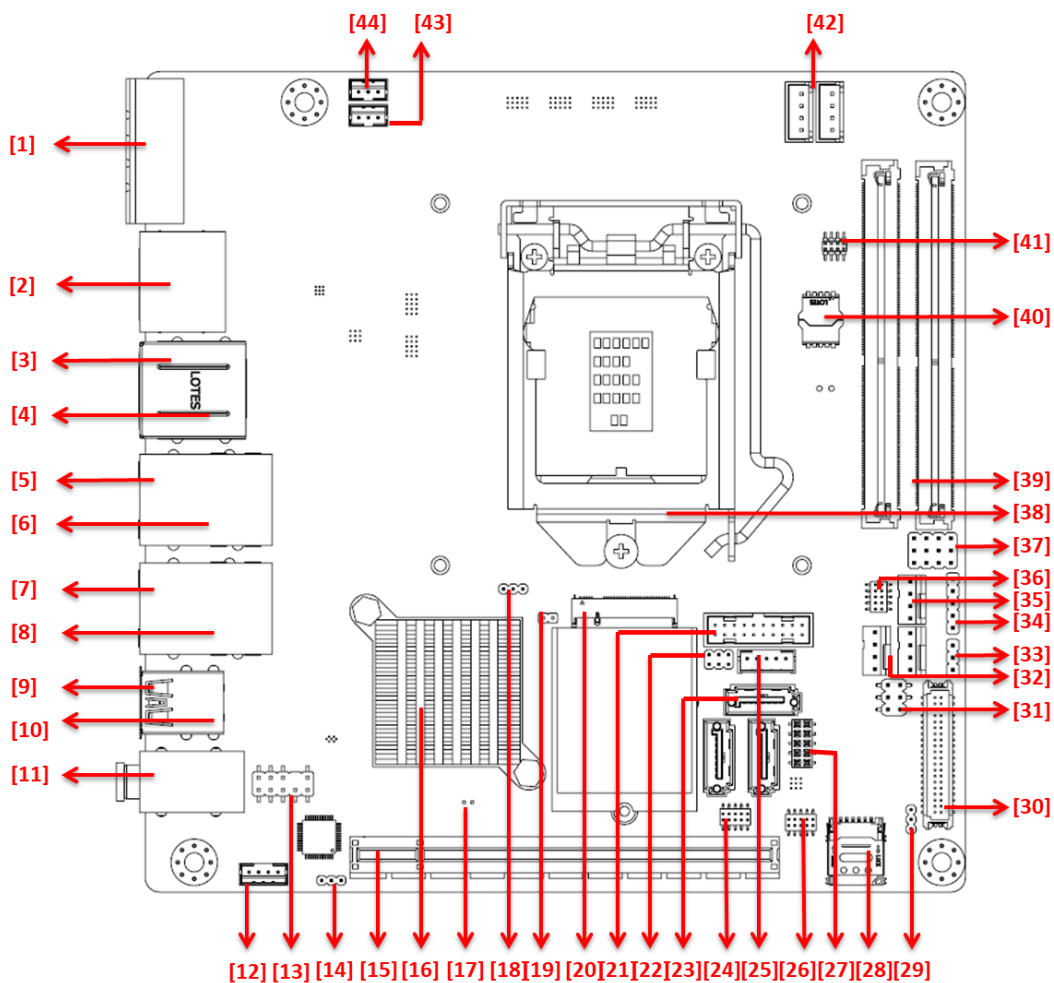

Figure 1.1 Jumper and Connector Location (Top Side)

1.DCIN1	18. JCASEOP_SW1	35. CPUFAN1
2.DP12	19. JCASE1	36. GPIO1
3.HDMI1	20. M2B1	37. JFP1
4.USB78	21. USB910	38. CPU1
5.USB12	22. JSETCOM1_V1	39. DIMMA1/DIMMB1
6.LAN1	23. SATA1~SATA3	40. SPI1
7.USB34	24. COM2	41. SPI_CN1
8.LAN2	25. INV1	42. SATA_PWR1/2
9.USB6	26. COM1	43. PSON1
10.USB5	27. LPC1	44. ATX_5VSB1
11.AUSIO1	28. SIM1	
12.AMP1	29. JLVDS_CON1	
13.FPAUD1	30. LVDS_EDP1	
14.JCOMS1	31. JLVDS1	
15.PCIEX16_1	32. SYSFAN1/2	
16.PCH1	33. JFP2	
17.BAT1	34. JWDT1+JOBS1	

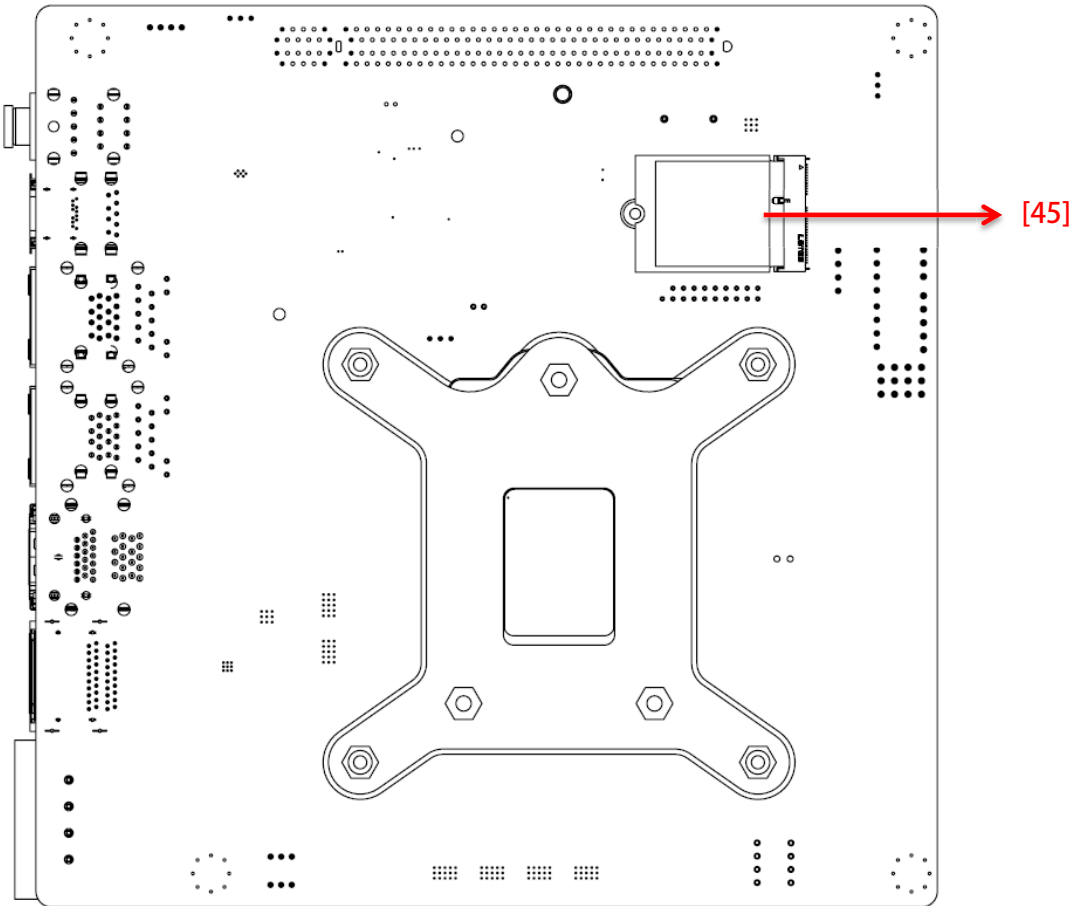

Figure 1.2 Jumper and Connector Location (Bottom Side)

45. M2E1

1.6 AIMB-276 Board Diagram

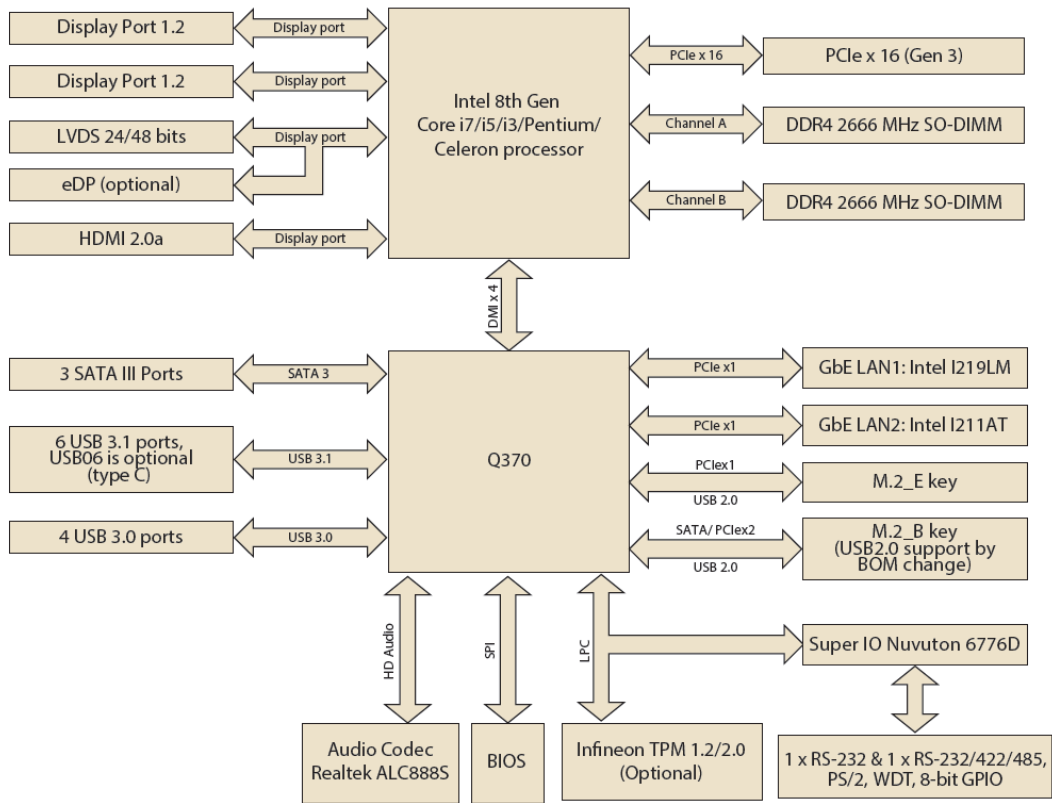

Figure 1.3 AIMB-276 Board Diagram

1.7 Safety Precautions

Warning! *Always completely disconnect the power cord from chassis whenever you work with the hardware. Do not make connections while the power is on. Sensitive electronic components can be damaged by sudden power surges. Only experienced electronics personnel should open the PC chassis.*



Caution! *Always ground yourself to remove any static charge before touching the motherboard. Modern electronic devices are very sensitive to electrostatic discharges. As a safety precaution, use a grounding wrist strap at all times. Place all electronic components on a static-dissipative surface or in a static-shielded bag when they are not in the chassis.*



Caution! *The computer is provided with a battery-powered real-time clock circuit. There is a danger of explosion if battery is incorrectly replaced. Replace only with same or equivalent type recommended by the manufacturer. Discard used batteries according to manufacturer's instructions.*



Caution! *There is a danger of a new battery exploding if it is incorrectly installed. Do not attempt to recharge, force open, or heat the battery. Replace the battery only with the same or equivalent type recommended by the manufacturer. Discard used batteries according to the manufacturer's instructions.*



1.8 Jumper Settings

This section provides instructions on how to configure your motherboard by setting the jumpers. It also includes the motherboards's default settings and your options for each jumper.



1.8.1 How to Set Jumpers

You can configure your motherboard to match the needs of your application by setting the jumpers. A jumper is a metal bridge that closes an electrical circuit. It consists of two metal pins and a small metal clip (often protected by a plastic cover) that slides over the pins to connect them. To “close” (or turn ON) a jumper, you connect the pins with the clip. To “open” (or turn OFF) a jumper, you remove the clip. Sometimes a jumper consists of a set of three pins, labeled 1, 2, and 3. In this case you connect either pins 1 and 2, or 2 and 3. A pair of needle-nose pliers may be useful when setting jumpers.

1.8.2 CMOS Clear (CMOS1)

The AIMB-276 motherboard contains a jumper that can erase CMOS data and reset the system BIOS information. Normally this jumper should be set with pins 1-2 closed. If you want to reset the CMOS data, set CMOS1 to 2-3 closed for just a few seconds, and then move the jumper back to 1-2 closed. This procedure will reset the CMOS to its default setting.

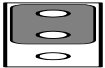
Table 1.3: CMOS1

Function	Jumper Setting
	1 2 3
*Keep CMOS data	 1-2 closed
	1 2 3
Clear CMOS data	 2-3 closed

* Default

1.8.3 Power Switch/HDD LED/SMBUS/Speaker Pin Header (JFP1)

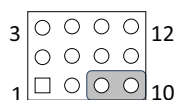

Table 1.4: Power Switch/HDD LED/SMBUS/Speaker Pin Header (JFP1)

Pin	Signal	Pin	Signal
1	+5V	2	HDDLED+
3	Power Button+	4	NC
5	HDDLED-	6	Power Button-
7	SPK_P3	8	SMB_DATA
9	System Reset+	10	SPK_P4
11	SMB_CLK	12	System Reset-

1.8.4 Power LED and Keyboard Lock Pin Header (JFP2)

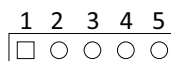
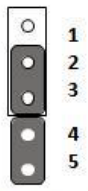
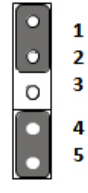

Table 1.5: Power LED and Keyboard Lock Pin Header (JFP2)

Pin	Signal
1	LED Power
2	NC
3	GND
4	Keyboard LOCK#
5	GND



1.8.5 Watchdog Timer Output and OBS Beep (JWDT1+JOBS1)

Table 1.6: Watchdog Timer Output and OBS Beep (JWDT1+JOBS1)

Function	Jumper Setting
Watchdog Timer Output(2-3) (Default) OBS BEEP(4-5) (Default)	 <p>(2 and 3)+(4 and 5)</p>
Watchdog Timer Disable (1-2) OBS BEEP(4-5) (Default)	 <p>(1 and 2)+(4 and 5)</p>

1.8.6 ATX/AT Mode Selection (PSON1)

Table 1.7: ATX/AT Mode Selection (PSON1)

Function	Jumper Setting
AT Mode	<p>1 2 3</p>  <p>1-2 closed</p>
ATX Mode (Default)	<p>1 2 3</p>  <p>2-3 closed</p>

1.8.7 LVDS Panel Voltage Selection (JLVDS1)

Table 1.8: LVDS Panel Voltage Selection (JLVDS1)

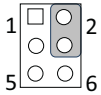
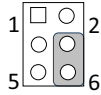
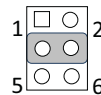
Function	Jumper Setting
Jumper position for 5V	 JLVDS1 (2-4)
Jumper position for 3.3V (Default)	 JLVDS1 (4-6)
Jumper position for 12V	 JLVDS1 (3-4)

1.8.8 COM2 RI# Pin RI#/5V/12V Select (JSETCOM2_V1)

Table 1.9: COM2 RI# Pin RI#/5V/12V Select (JSETCOM2_V1)

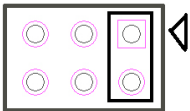
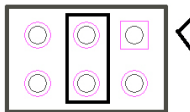
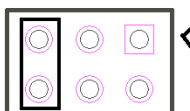
Function	Jumper Setting
Jumper position for RI#(Default)	 1 and 2
Jumper position for 5V	 3 and 4
Jumper position for 12V	 5 and 6

1.9 System Memory

AIMB-276 has two sockets for a 260 pins DDR4 SO-DIMM. This socket uses a 1.2 V unbuffered double data rate synchronous DRAM (DDR SDRAM). DRAM is available in capacities of 4GB, 8GB and 16GB. The sockets can be filled in any combination with SODIMMs of any size, giving a total memory size between 4GB, 8GB, 16GB, and up to max 32GB. AIMB-276 does NOT support ECC (error checking and correction).

1.10 Memory Installation Procedures

To install SODIMMs, first make sure the two handles of the SODIMM socket are in the “open” position, i.e., the handles lean outward. Slowly slide the SODIMM module along the plastic guides on both ends of the socket. Then firmly but gently (avoid pushing down too hard) press the SODIMM module well down into the socket, until you hear a click when the two handles have automatically locked the memory module into the correct position of the SODIMM socket. To remove the memory module, just push both handles outward, and the memory module will be ejected by the mechanism.

1.11 Cache Memory

The AIMB-276 supports a CPU with one of the following built-in full speed Last Level Cache:

8MB for Intel Core i7-6700 / i7-6700TE

6MB for Intel Core i5-6500 / i5-6500TE

4MB for Intel Core i3-6100 / i3-6100TE

3MB for Pentium G4400 / G4400GE

2MB for Celeron G3900 / G3900GE

The built-in second-level cache in the processor yields much higher performance than conventional external cache memories.

1.12 Processor Installation

The AIMB-276 is designed to supported Intel 6th Gen LGA1151, Core i7/Core i5/ Core i3, Pentium, Celeron processor.

Chapter 2

Connecting
Peripherals

2.1 Introduction

You can access most of the connectors from the top of the board as it is being installed in the chassis. If you have a number of cards installed or have a packed chassis, you may need to partially remove the card to make all the connections.

2.2 USB Ports (LAN1_USB12/LAN2_USB34/USB56/USB78/USB910)

The AIMB-276 provides up to ten USB ports. Eight USB3.1 on the rear side and two pin header on the board. The USB interface complies with USB Specification Rev. 3.1 supporting transmission rates up to 10 Gbps. The USB interface can be disabled in the system BIOS setup.

The AIMB-276 is equipped with two high-performance 1000 Mbps Ethernet LAN adapter, which are supported by all major network operating systems. The RJ-45 jacks on the rear panel provides for convenient LAN connection.

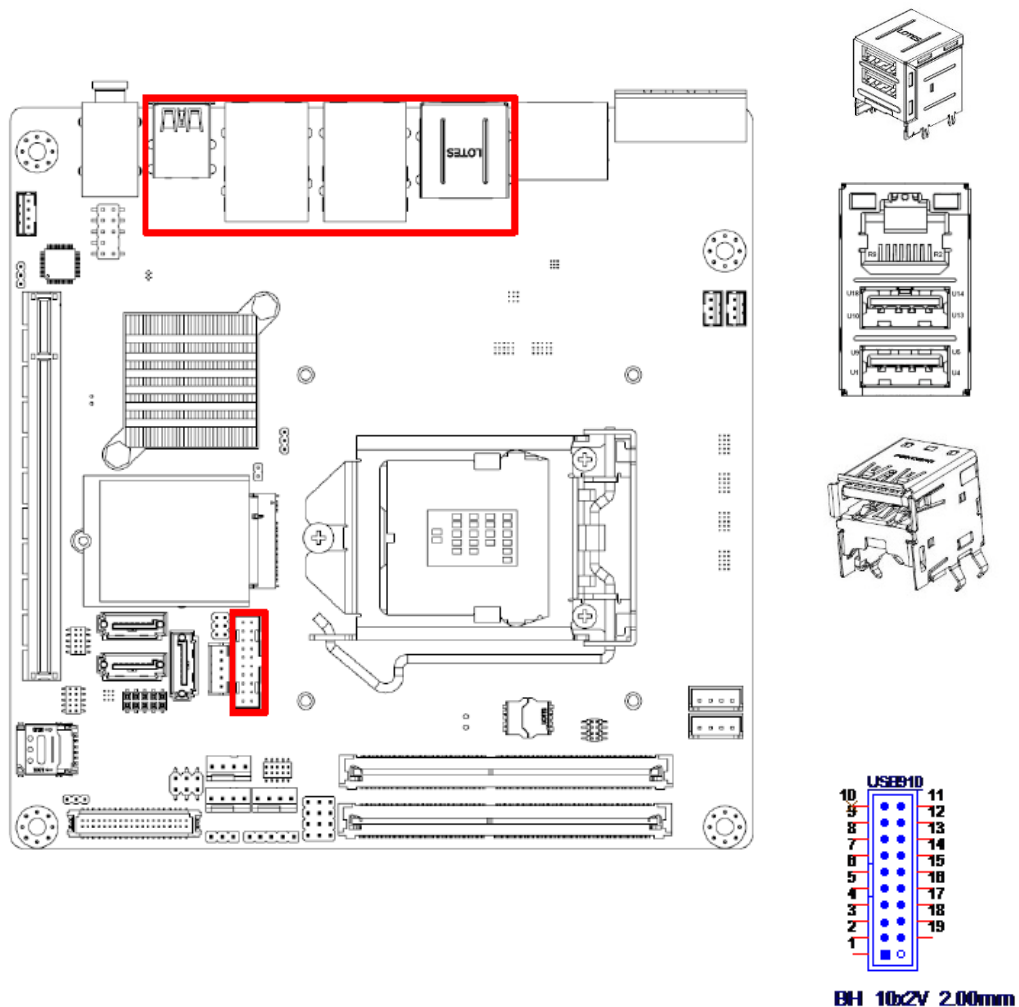
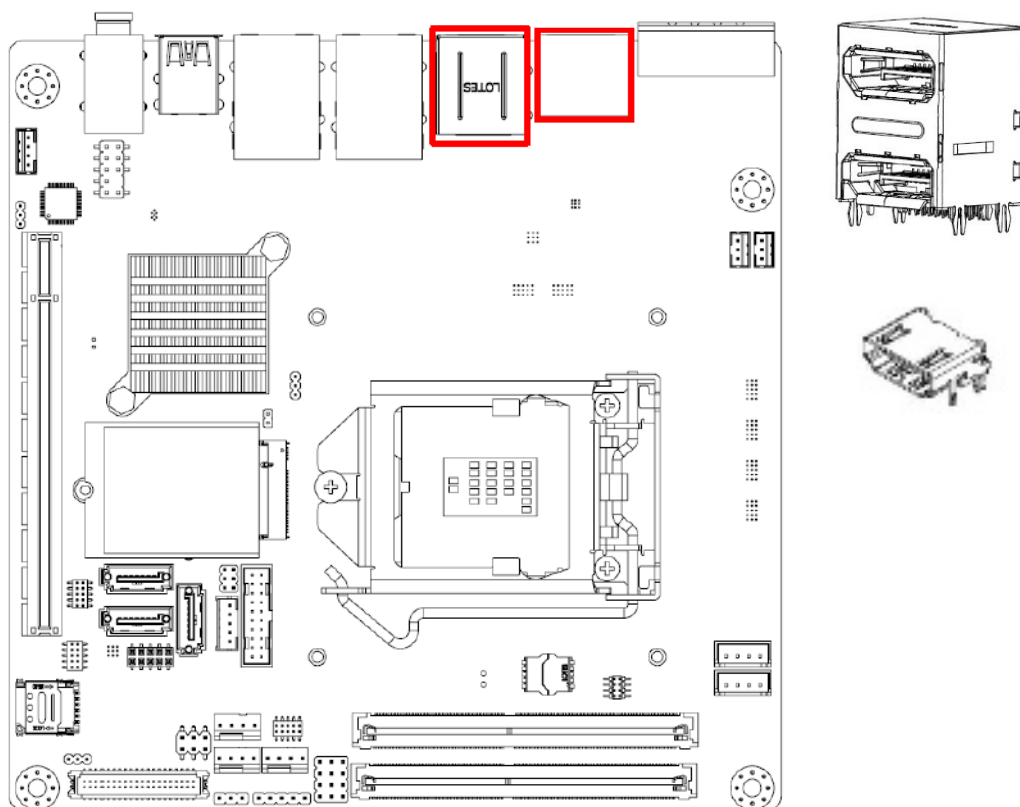

Table 2.1: LAN LED Indicator

LAN Mode	LAN Indicator	
LAN1 indicator	LED1 (Right)	off for mal-link; Link (On) / Active (Flash)
	LED2 (Left)	100 Mbps (On) / 10 Mbps (Off); Color: Orange (10/100 Mbps)
	LED2 (Left)	1000 Mbps (On); Color: Green (1000 Mbps)
LAN2 indicator	LED1 (Right)	off for mal-link; Link (On) / Active (Flash)
	LED2 (Left)	100 Mbps (On) / 10 Mbps (Off); Color: Orange (10/100 Mbps)
	LED2 (Left)	1000 Mbps (On); Color: Green (1000 Mbps)

2.3 DisplayPort1/2 (DP12) / High-Definition Multimedia Interface connector (HDMI1)

The AIMB-276 includes two DP and one HDMI connector, which can support DP and HDMI outputs. Pin assignments for DP & HDMI are detailed in Appendix B.



2.4 Serial Ports (COM1~COM2)

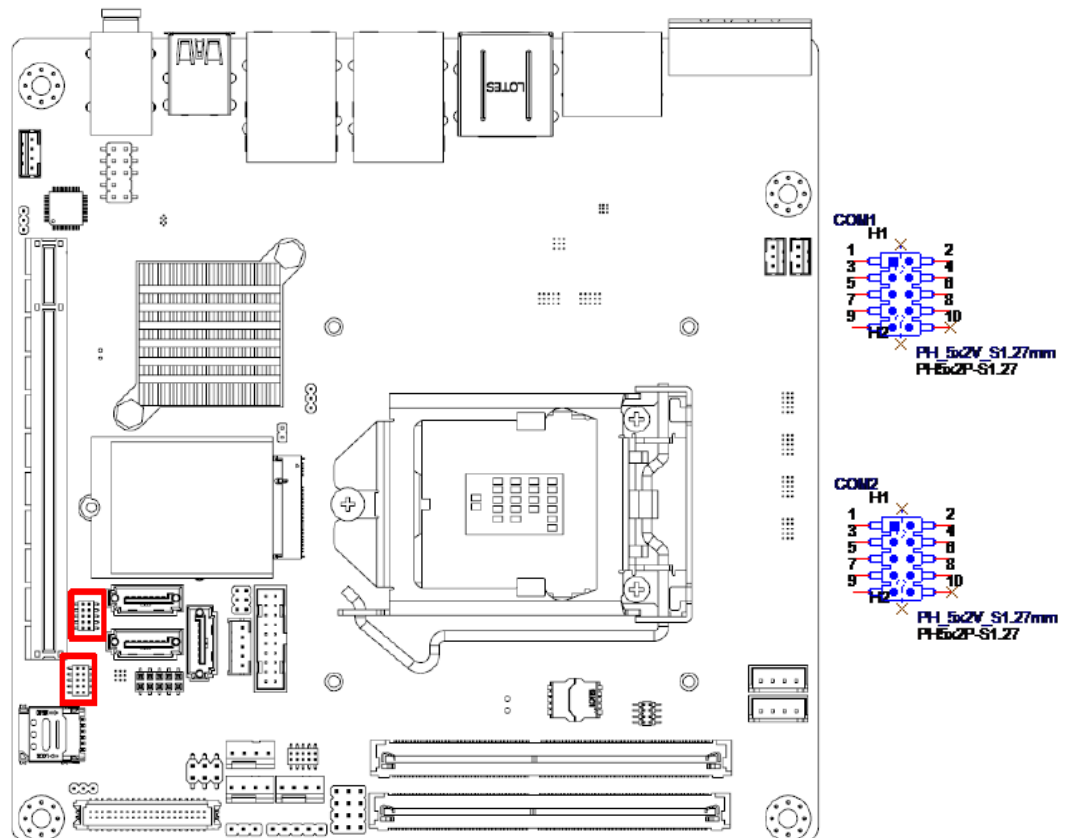

AIMB-276 supports two serial ports, COM1 supports RS-232 function, COM2 supports RS-232/422/485 function by BIOS selection. These ports can connect to serial devices, such as a mouse or a printer, or to a communications network. The IRQ and address ranges for both ports are fixed. However, if you want to disable the port or change these parameters later, you can do this in the system BIOS setup. Different devices implement the RS-232 standards in different ways. If you have problems with a serial device, be sure to check the pin assignments for the connector

2.5 CPU Fan Connector (CPU_FAN1)

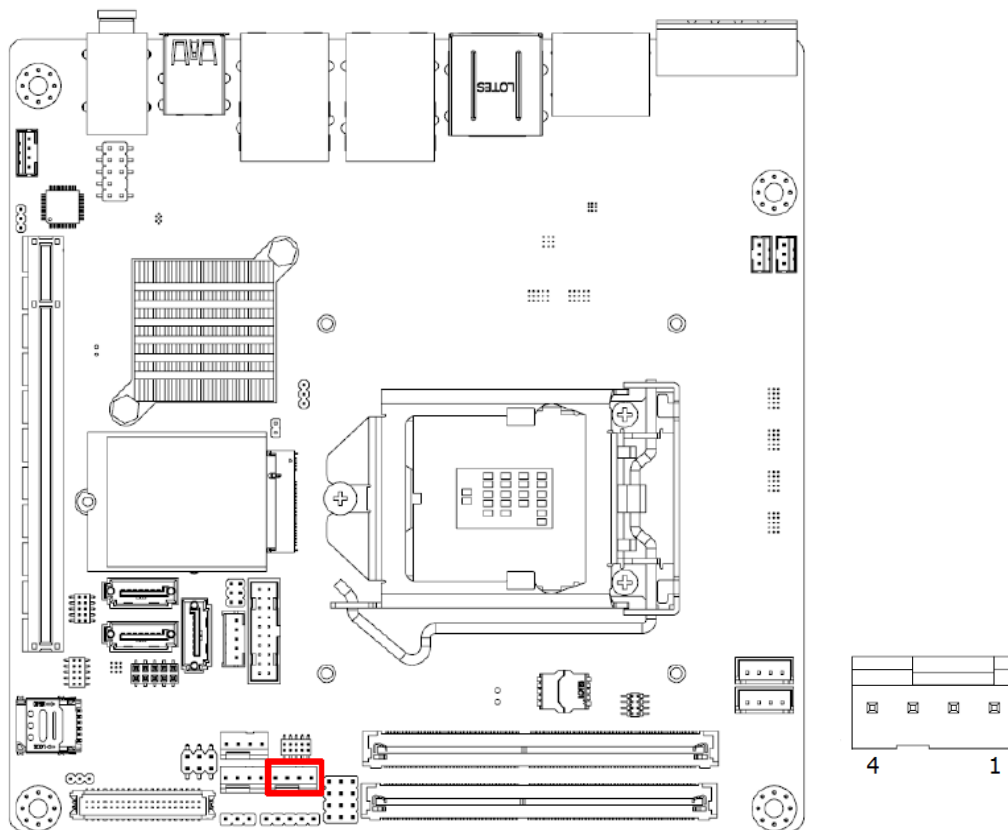

If a fan is used, this connector supports cooling fans of 500 mA (6 W) or less.

2.6 System FAN Connector (SYSFAN1/2)

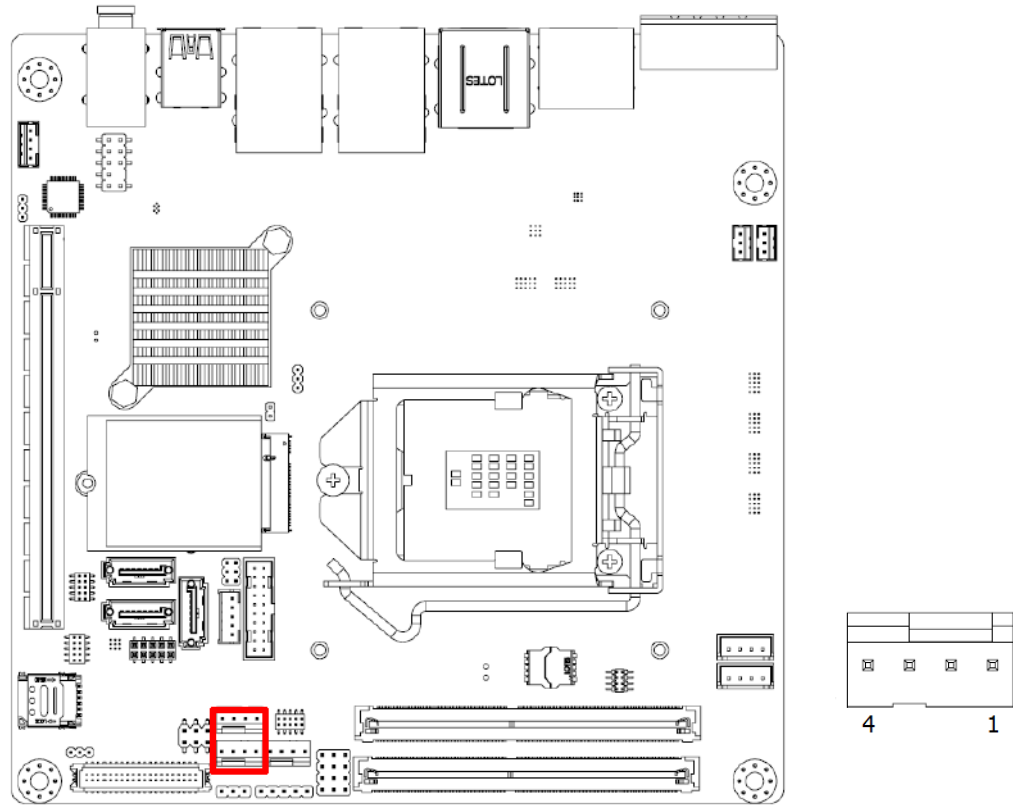

If a fan is used, this connector supports cooling fans of 500 mA (6 W) or less.

2.7 Power Switch/HDD LED/SMBUS/Speaker Pin Header (JFP1) & Power LED and Keyboard Lock Pin Header (JFP2)

There are several headers for monitoring and controlling the AIMB-276.

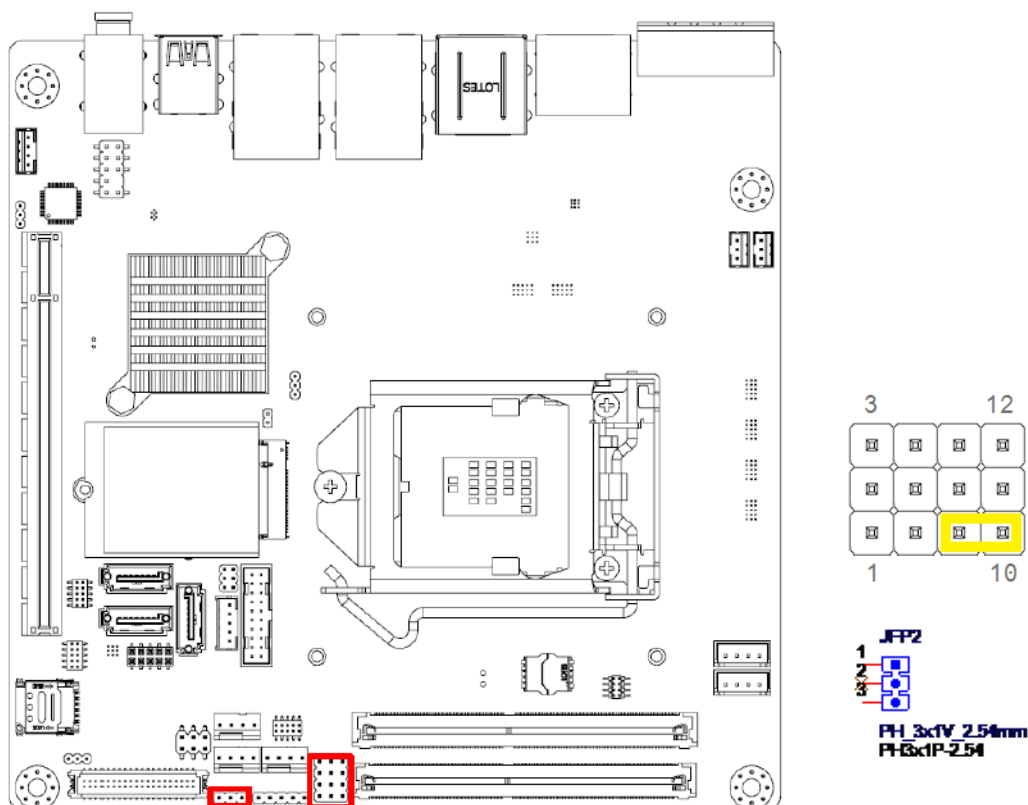

2.7.1 ATX soft power switch (JFP1/PWR_SW)

If your computer case is equipped with an ATX power supply, you should connect the power on/off button on your computer case to (JFP1/ PWR_SW), for convenient power on and off.

2.7.2 Reset (JFP1/RESET)

Many computer cases offer the convenience of a reset button. Connect the wire for the reset button.

2.7.3 HDD LED (JFP1/HDDLED)

You can connect an LED to connector (JFP1/HDDLED) to indicate when the HDD is active.

2.7.4 External speaker (JFP1/SPEAKER)

JFP1/SPEAKER is a 4-pin connector for an external speaker. If there is no external speaker, the AIMB-276 provides an onboard buzzer as an alternative. To enable the buzzer, set pins 7 & 10 as closed.

2.8 DC Input Phoenix Connector (DCIN1)

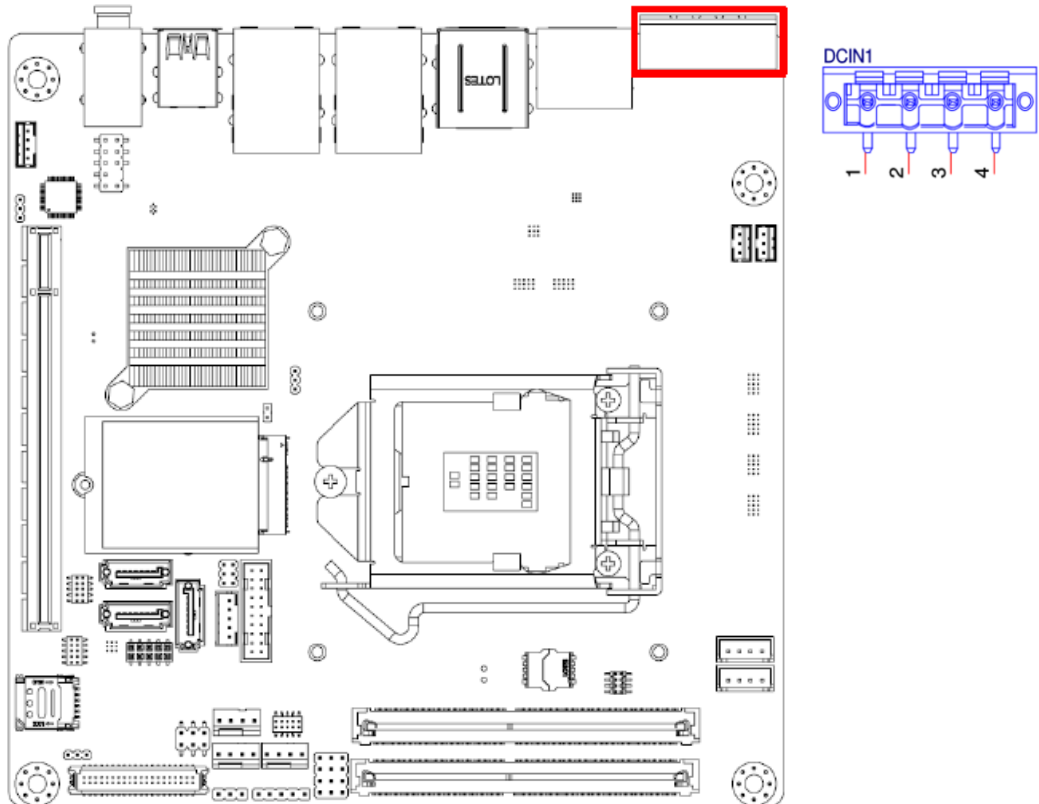

2.9 SATA Signal & Power Connector (SATA1~SATA3 / SATA_PWR1~2)

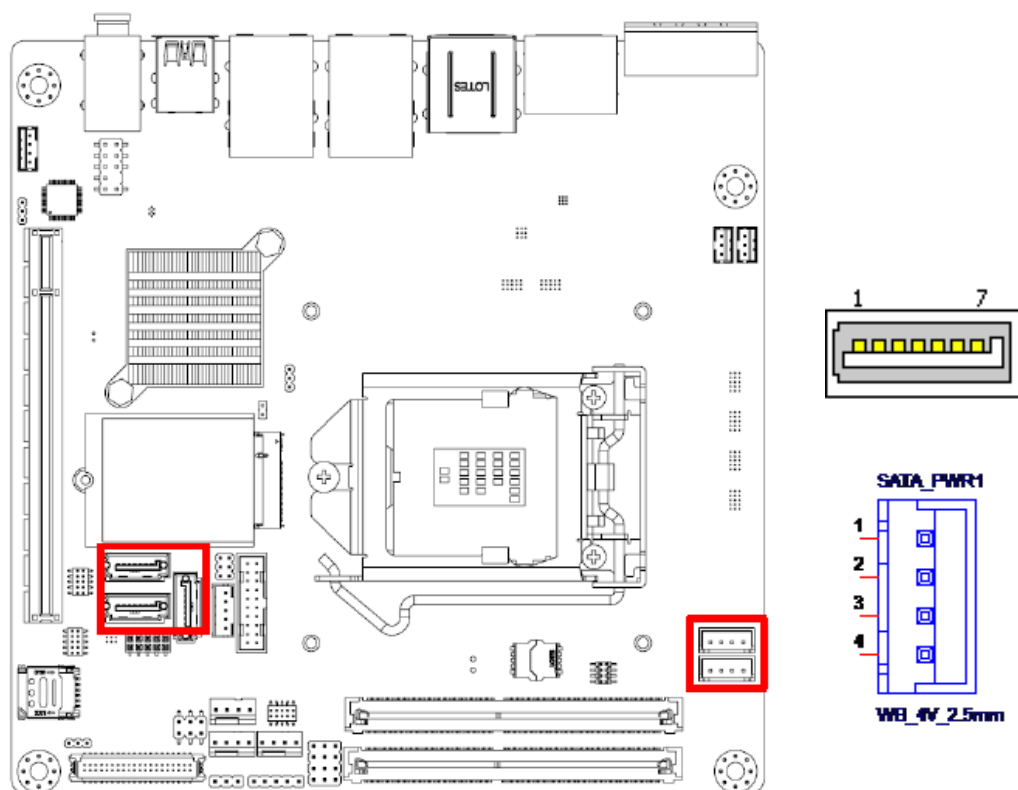

AIMB-276 features a high performance Serial ATA III interface (up to 600 MB/s) which eases hard drive cabling with thin, space-saving cables.

2.10 HD Analog Audio Interface (AUDIO1, FPAUD1)

Front headphone connector (FPAUD1) is for a chassis-mounted front panel audio I/O module that supports either HD Audio or legacy AC'97 (optional) audio standard. Connect this connector with the front panel audio I/O module cable.

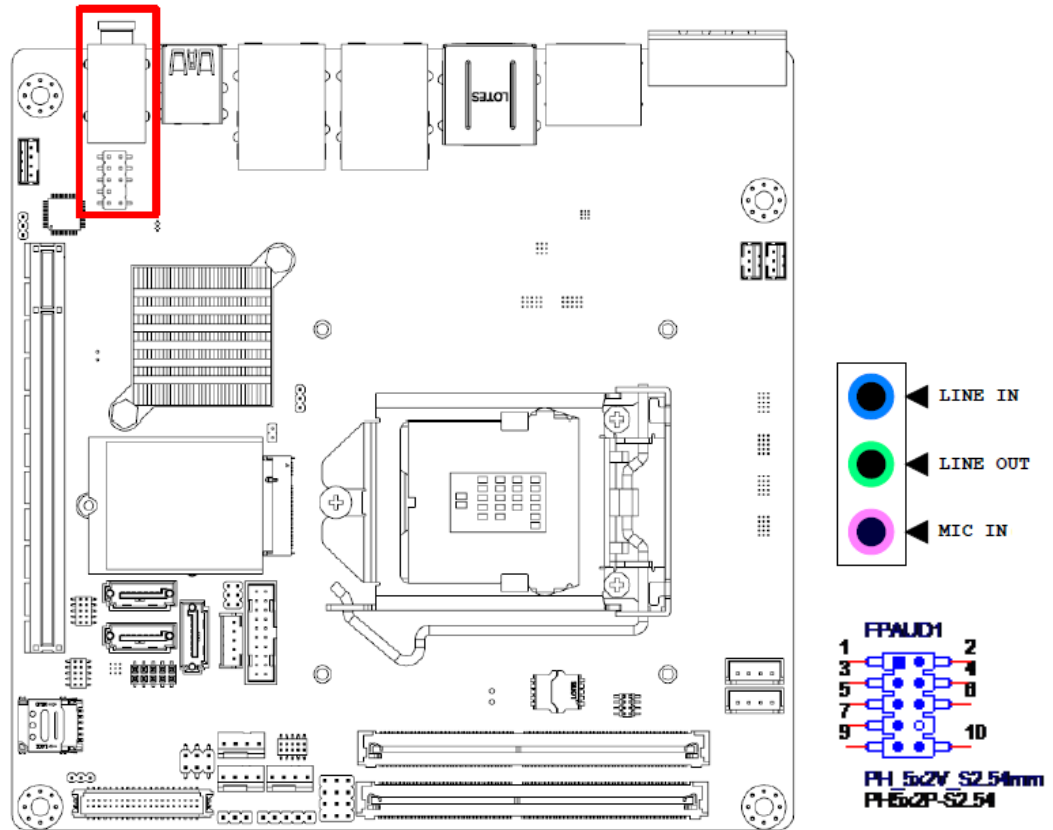

Note! *For motherboards with the optional HD Audio feature, we recommend that you connect a high-definition front panel audio module to this connector to take advantage of the motherboard's high definition audio capability.*



2.11 PCI-E x16 Slot (PCIEX16_1)

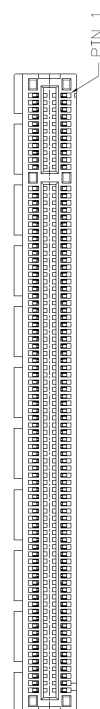
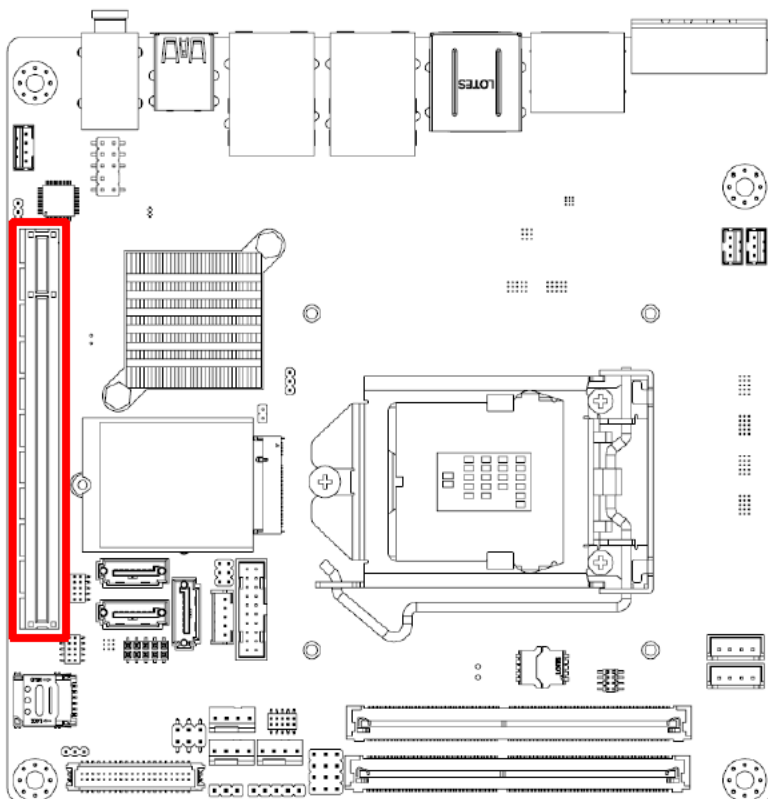

AIMB-276 provides 1 x PCI express x16 slot.

2.12 Low-voltage differential signaling interface/ Embedded display port (LVDS_EDP1)

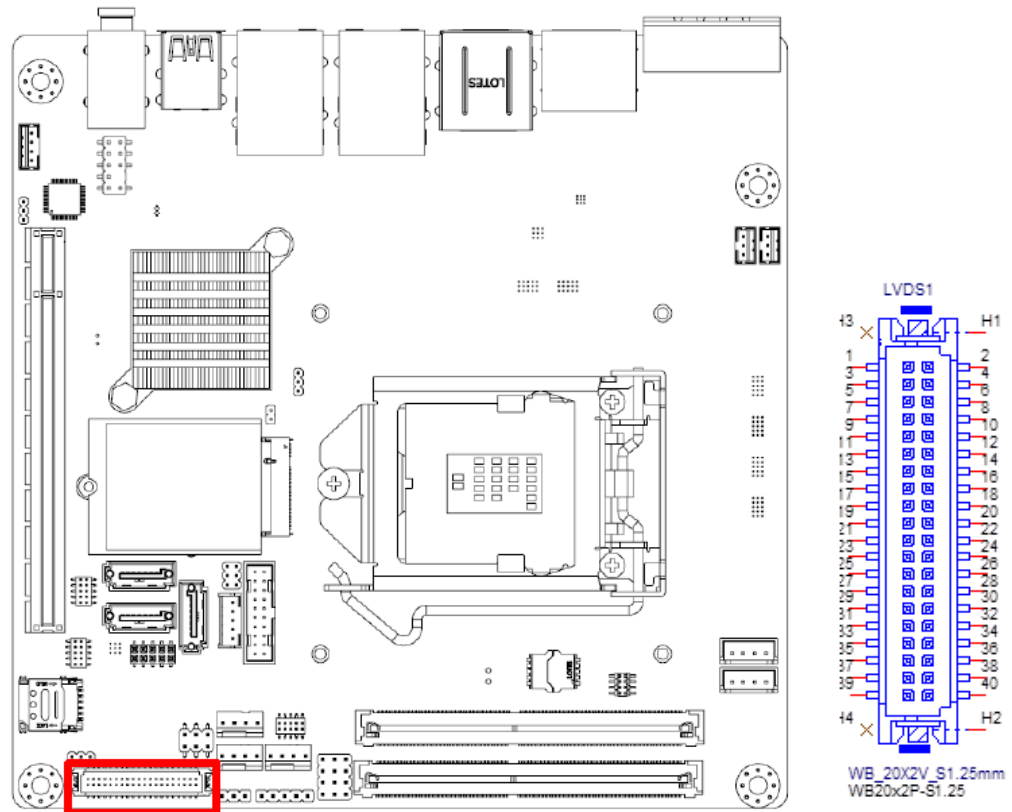

2.13 LVDS Backlight Inverter Power Connector (INV1)

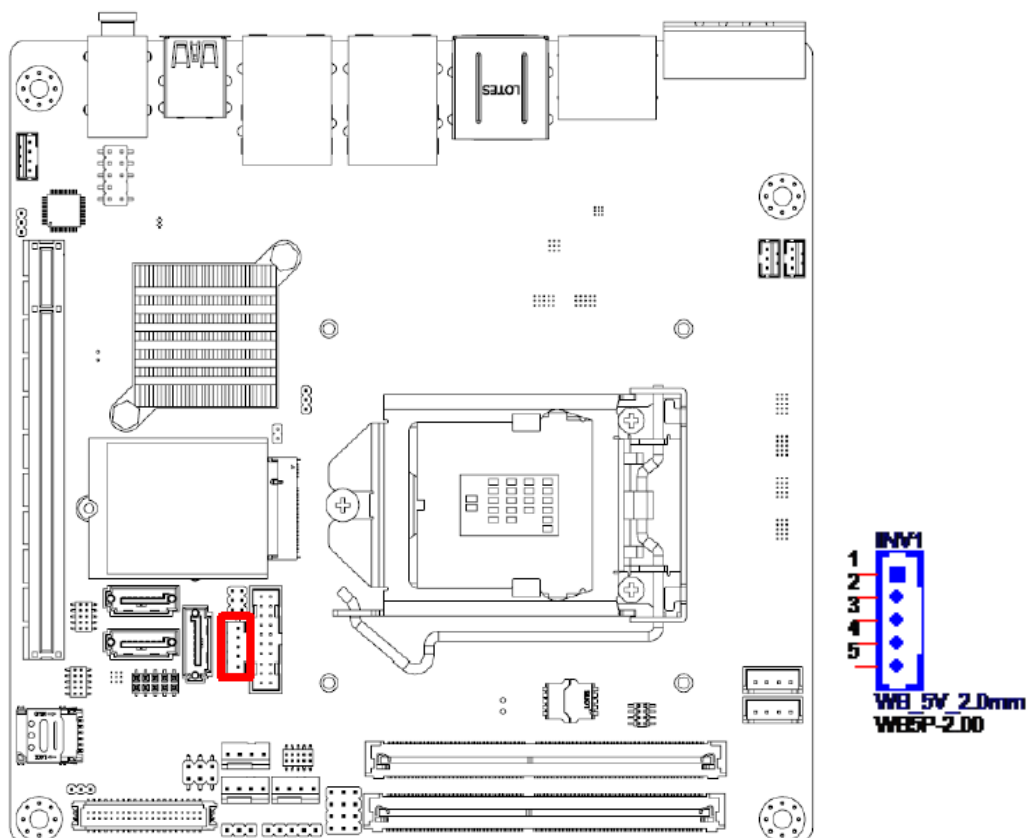

Note! ■ **Signal Description**



Signal

VR

ENBKL

Signal Description

Vadj=0.75 V

(Recommended: 4.7 kΩ > 1/16 W)

LCD backlight ON/OFF control signal

2.14 NGFF M.2 B-Key & E-Key connector (M2B1 & M2E1)

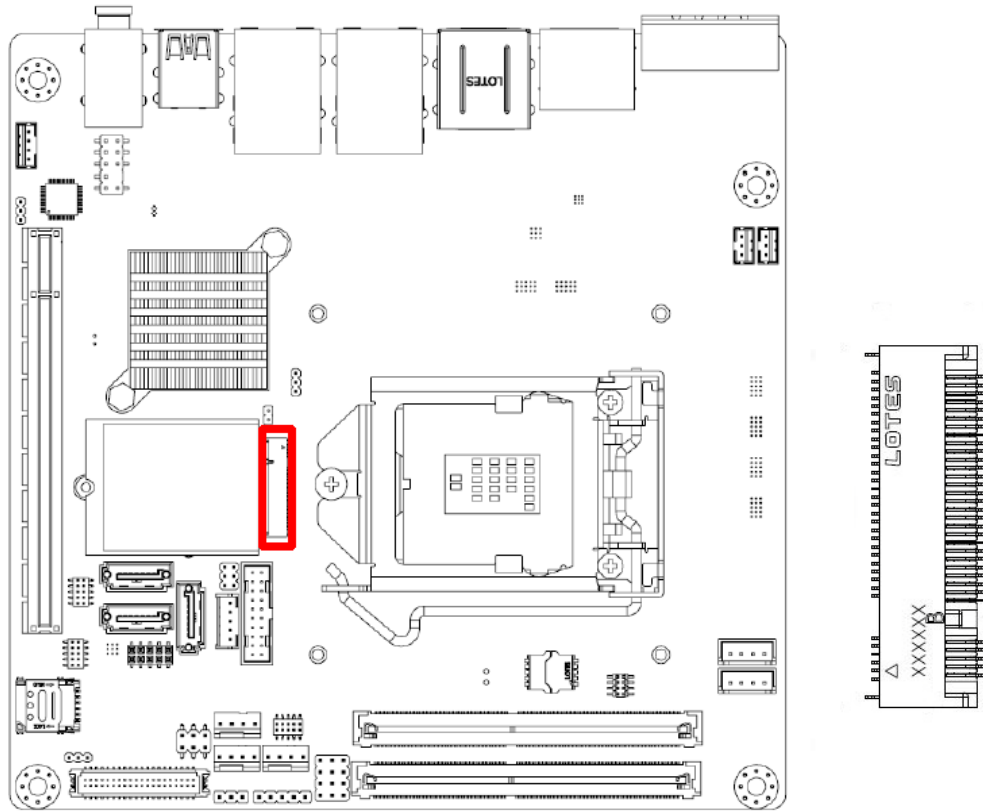

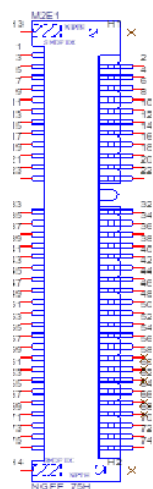
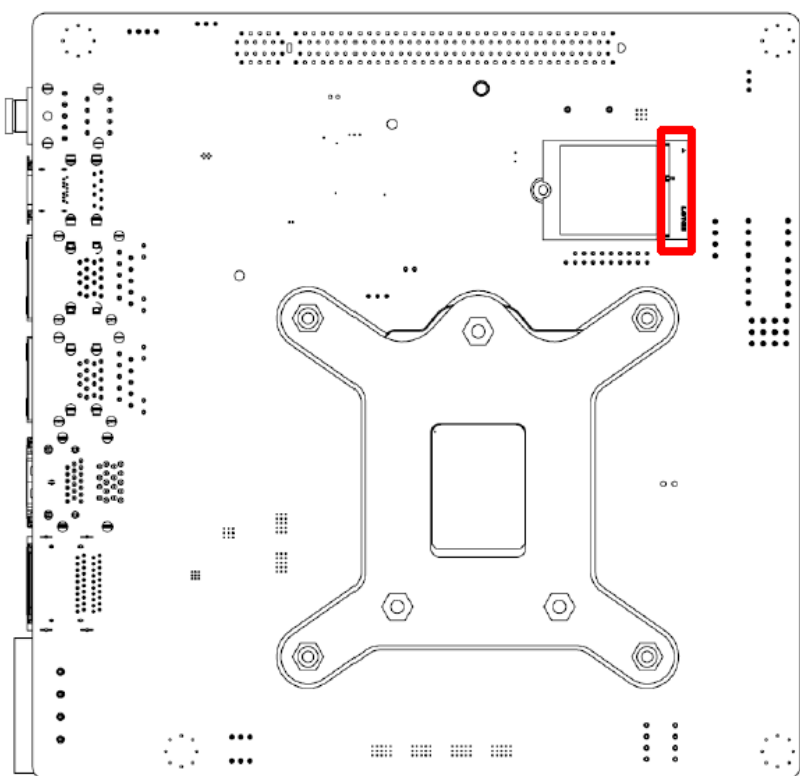

2.15 Audio Amplifier Output Connector (AMP1), BOM optional

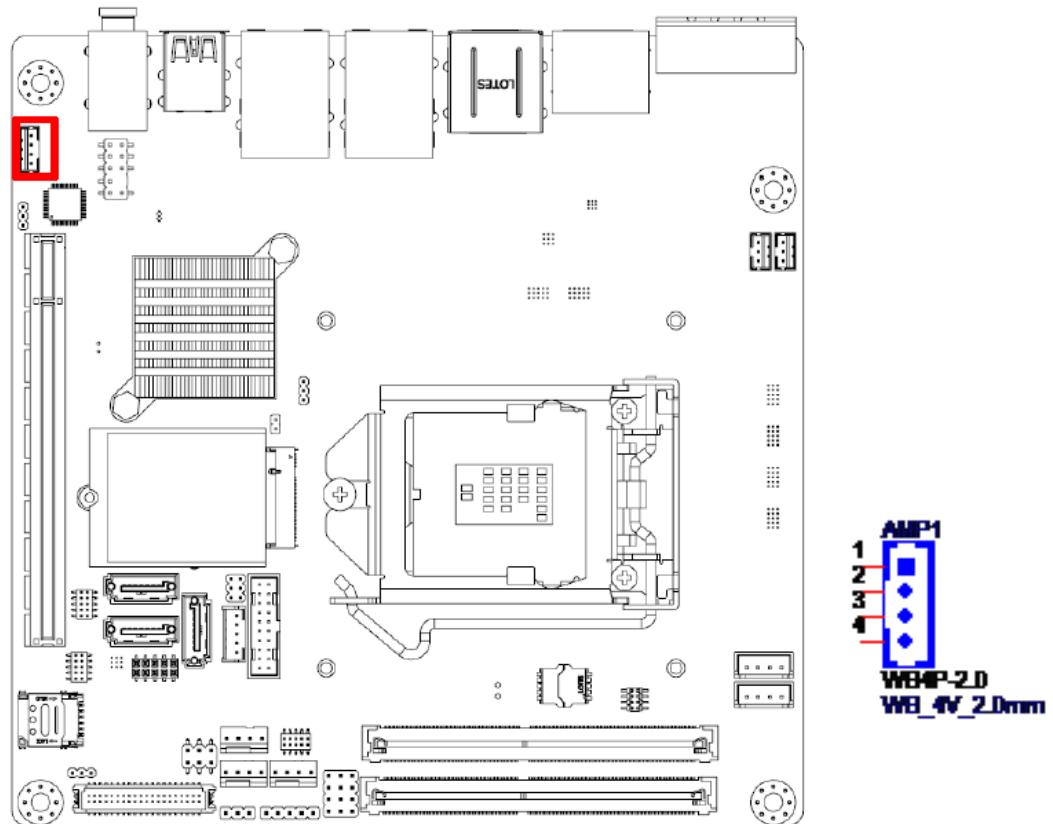

2.16 General Purpose I/O Pin Header (GPIO1)

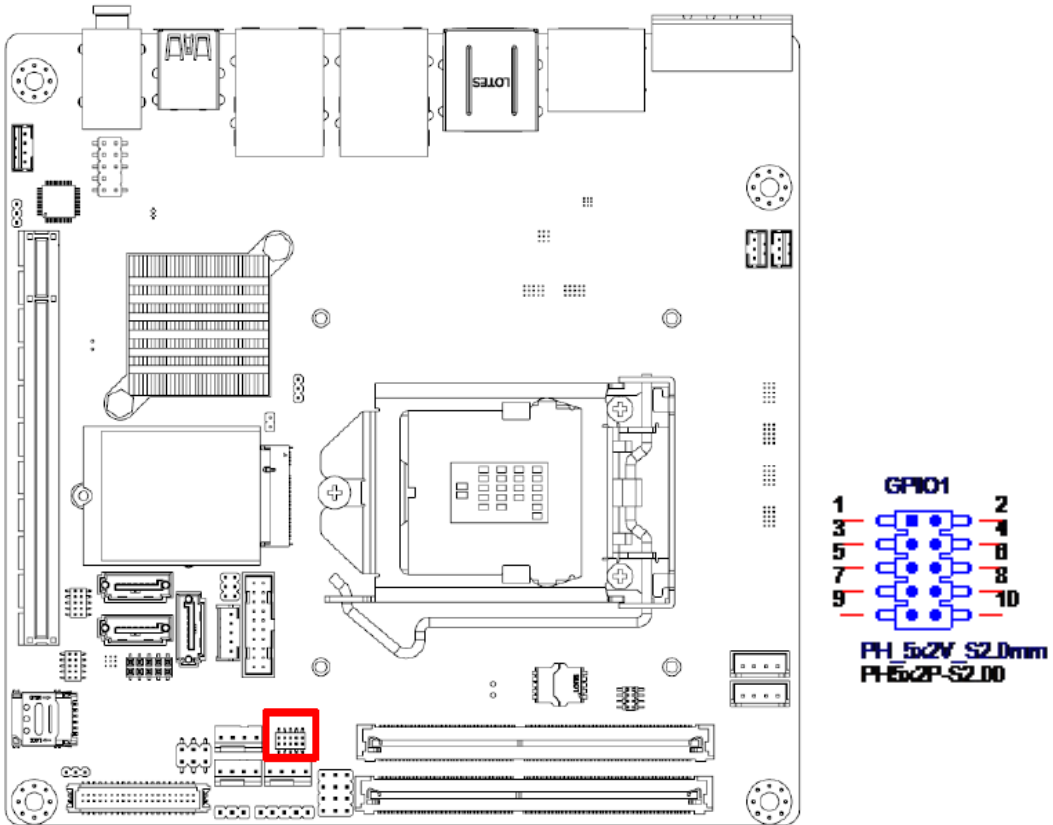

2.17 SPI BIOS Flash Socket (SPI1)

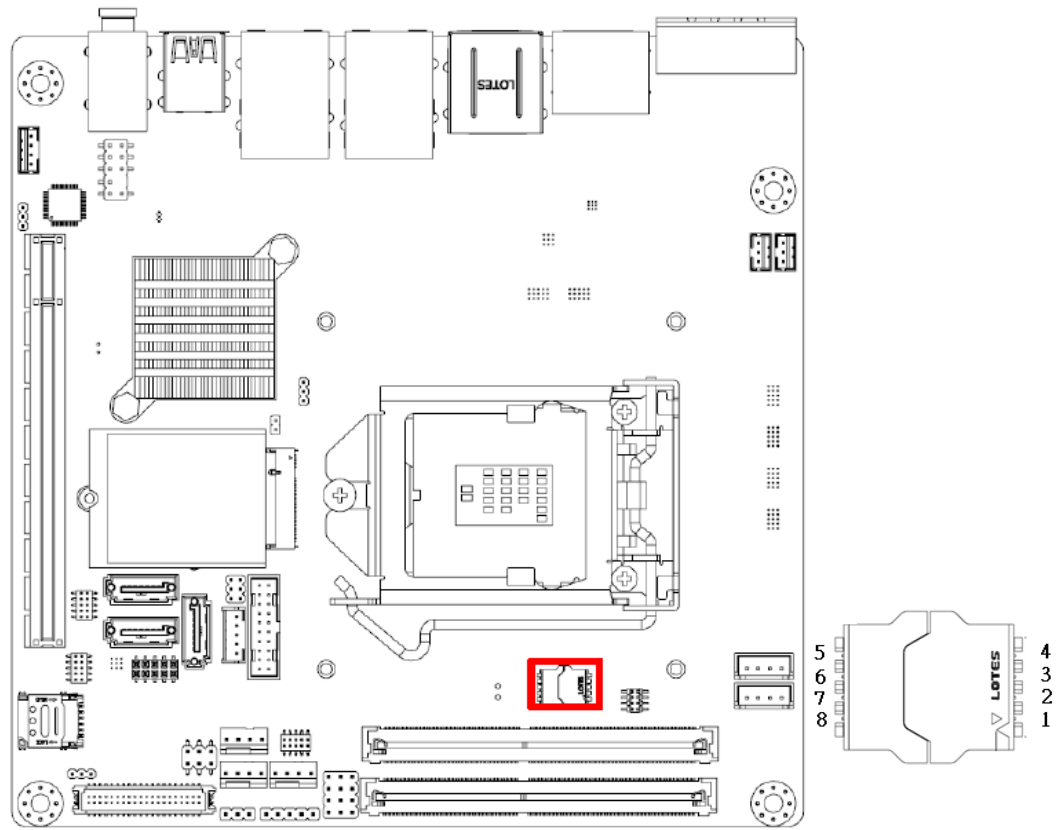

2.18 SPI Programming Pin Header (SPI_CN1)

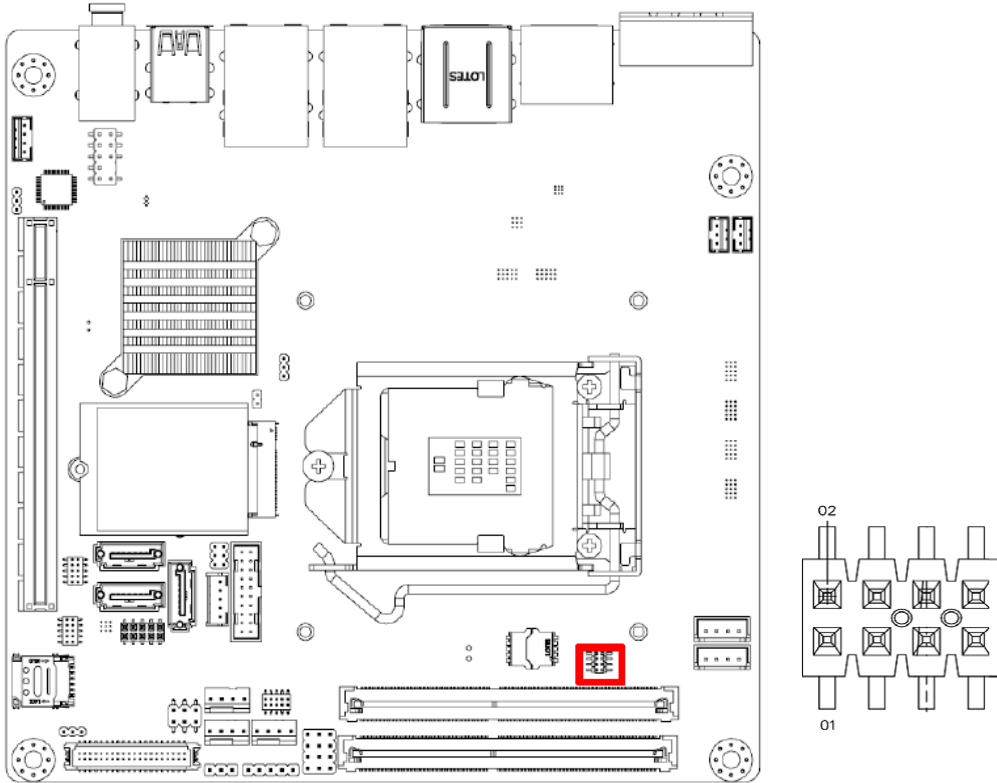

2.19 Low Pin Count Header (LPC1)

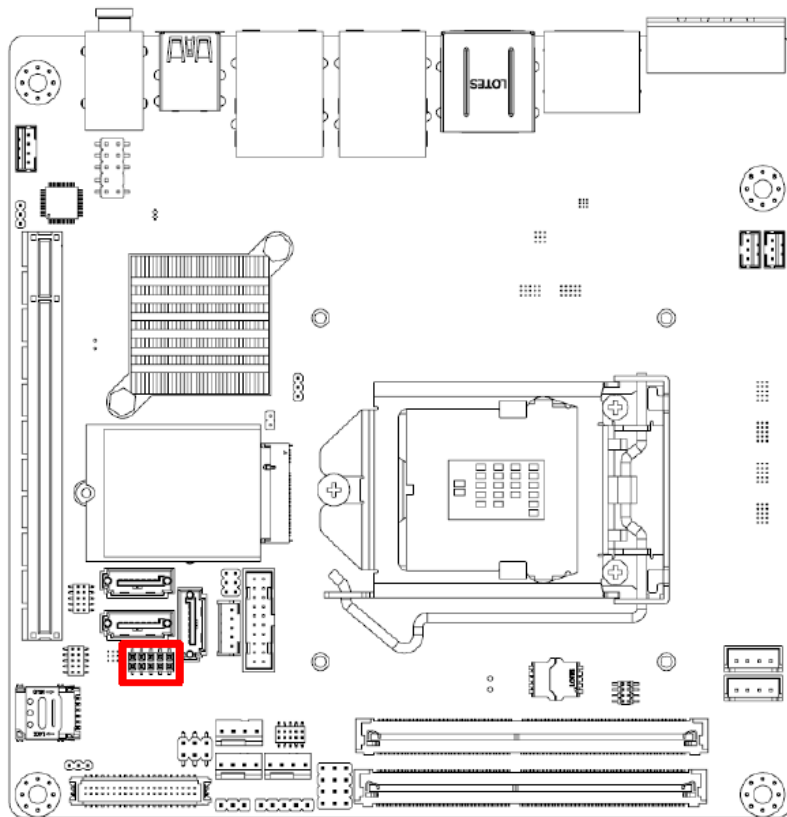

2.20 Case-Open Detect Connector (JCASE1)

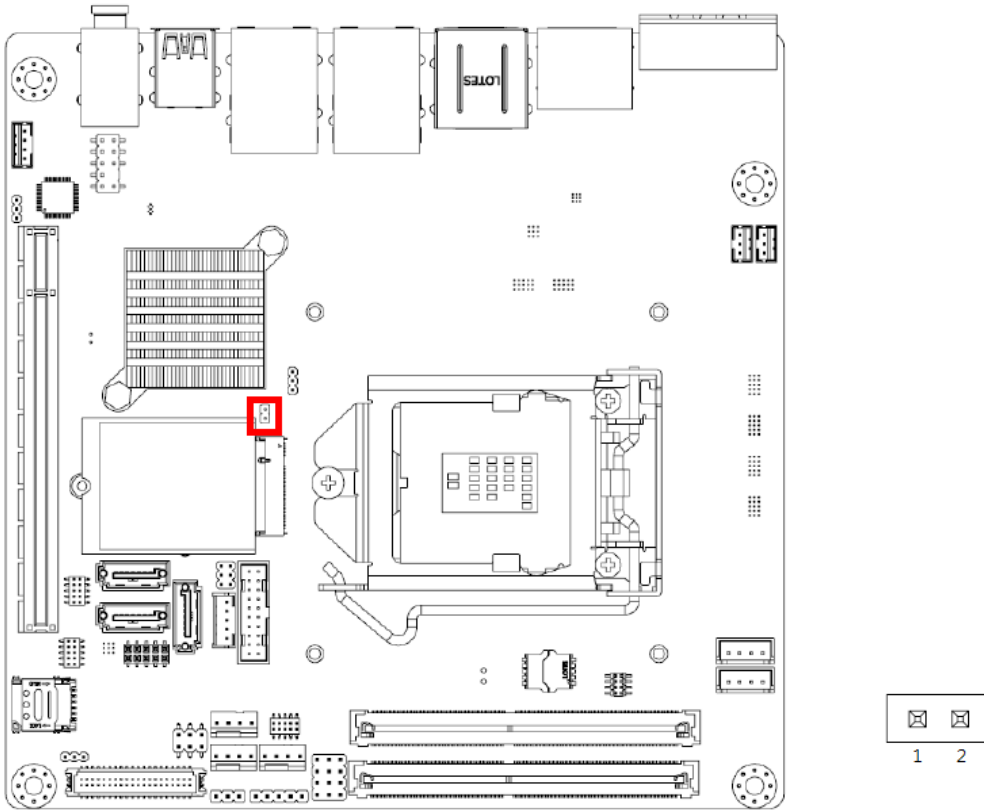

2.21 CMOS battery connector (BAT1)

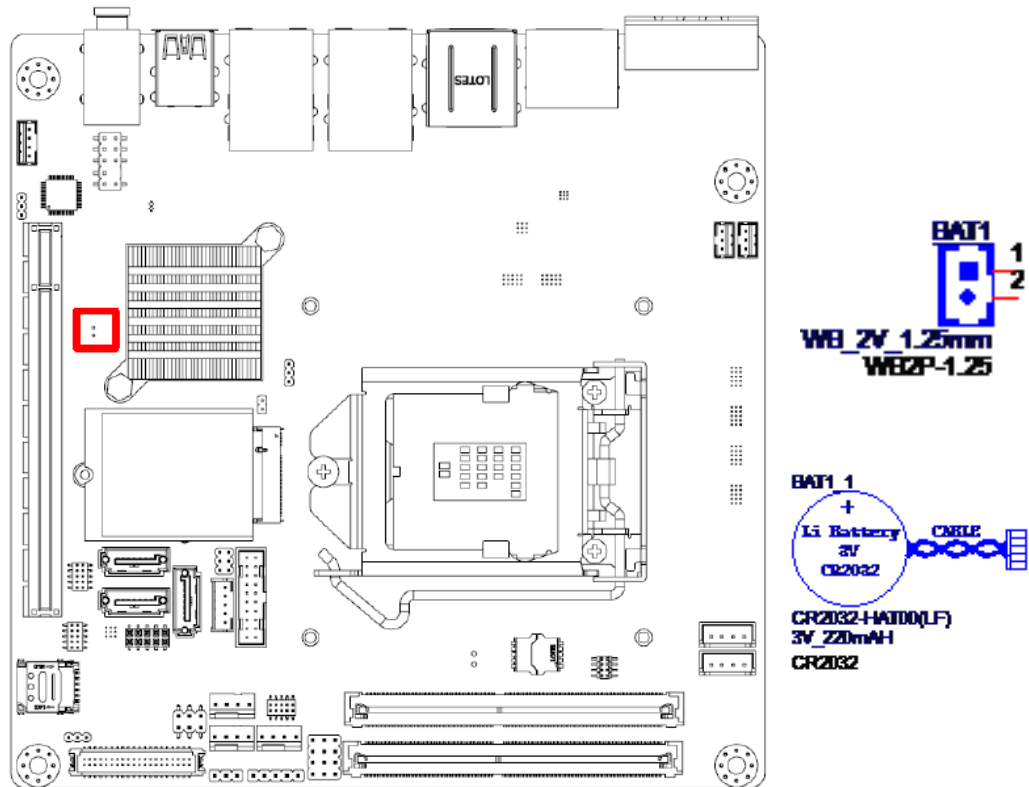

2.22 CPU Socket (CPU1)

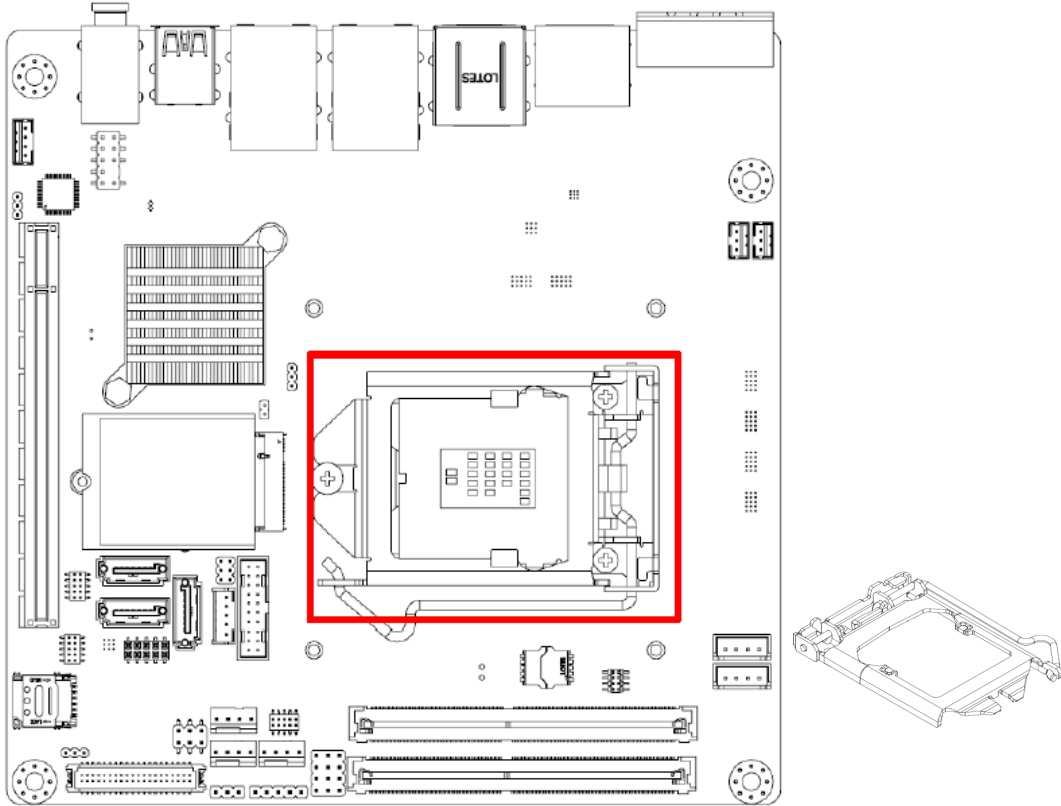

2.23 DDR4 SO-DIMM Socket (DIMMA1, DIMMB1)

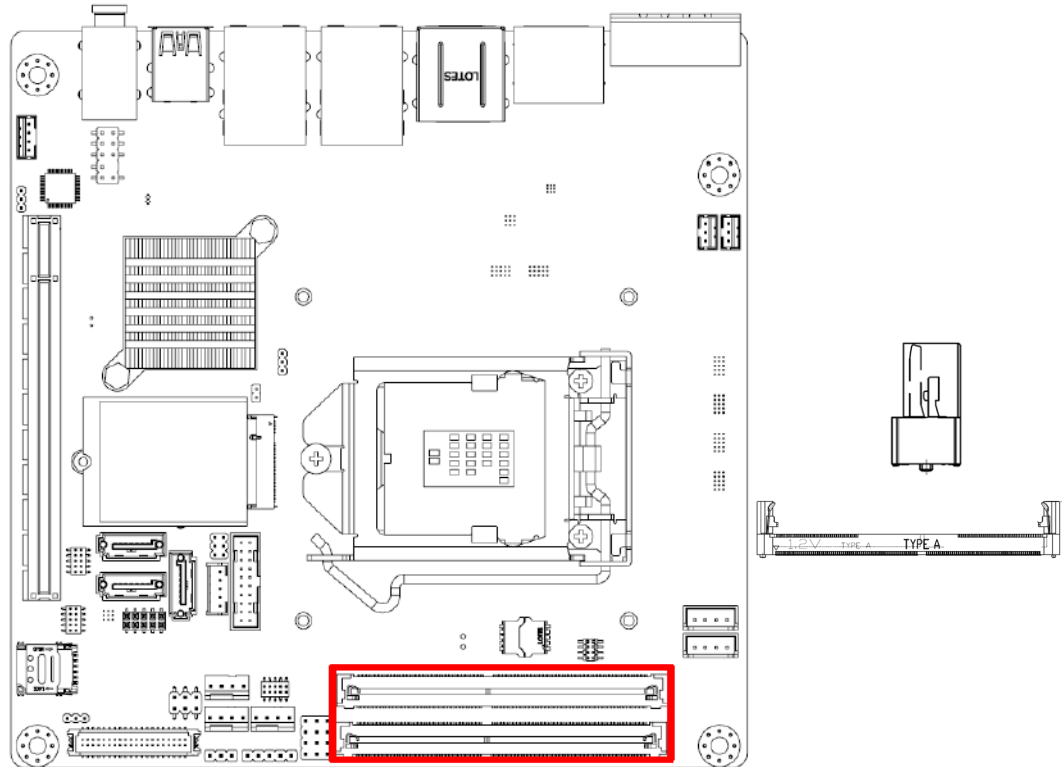

Chapter 3

BIOS Operation

3.1 Introduction

With the AMI BIOS Setup program, you can modify BIOS settings and control the special features of your computer. The Setup program uses a number of menus for making changes and turning special features on or off. This chapter describes the basic navigation of the AIMB-276 setup screens.

3.2 BIOS Setup

The AIMB-276 Series system has AMI BIOS built in, with a CMOS SETUP utility that allows users to configure required settings or to activate certain system features. The CMOS SETUP saves the configuration in the CMOS RAM of the motherboard. When the power is turned off, the battery on the board supplies the necessary power to preserve the CMOS RAM. When the power is turned on, press the button during the BIOS POST (Power-On Self Test) to access the CMOS SETUP screen.

Control Keys

< ↑ >< ↓ >< ← >< → >	Move to select item
----------------------	---------------------

<Enter>	Select Item
---------	-------------

<Esc>	Main Menu - Quit and not save changes into CMOS Sub Menu - Exit current page and return to Main Menu
-------	---

<Page Up/+>	Increase the numeric value or make changes
-------------	--

<Page Down/->	Decrease the numeric value or make changes
---------------	--

<F1>	General help, for Setup Sub Menu
------	----------------------------------

<F2>	Item Help
------	-----------

<F5>	Load Previous Values
------	----------------------

<F7>	Load Setup Defaults
------	---------------------

<F10>	Save all CMOS changes
-------	-----------------------

3.2.1 Main Menu

Press to enter AMI BIOS CMOS Setup Utility, the Main Menu will appear on the screen. Use arrow keys to select among the items and press <Enter> to accept or enter the sub-menu.



The Main BIOS setup screen has two main frames. The left frame displays all the options that can be configured. Grayed-out options cannot be configured; options in blue can. The right frame displays the key legend.

Above the key legend is an area reserved for a text message. When an option is selected in the left frame, it is highlighted in white. Often a text message will accompany it.

■ System time / System date

Use this option to change the system time and date. Highlight System Time or System Date using the <Arrow> keys. Enter new values through the keyboard. Press the <Tab> key or the <Arrow> keys to move between fields. The date must be entered in MM/DD/YY format. The time must be entered in HH:MM:SS format.

3.2.2 Advanced BIOS Features

Select the Advanced tab from the AIMB-276 setup screen to enter the Advanced BIOS Setup screen. You can select any of the items in the left frame of the screen, such as CPU Configuration, to go to the sub menu for that item. You can display an Advanced BIOS Setup option by highlighting it using the <Arrow> keys. All Advanced BIOS Setup options are described in this section. The Advanced BIOS Setup screen is shown below. The sub menus are described on the following pages.

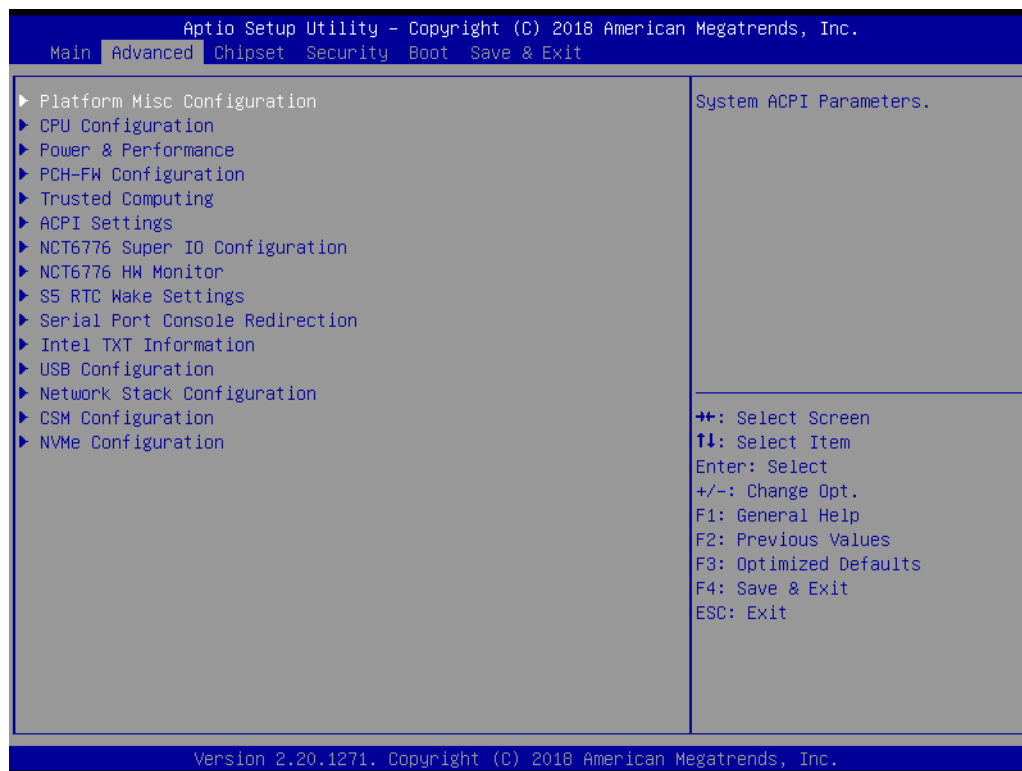

3.2.2.1 Trusted Computing

To enable/disable TPM (TPM 1.2/2.0) set up in BIOS. TPM (Trusted Platform Module) is a secure key generator and key cache management component, enables protected storage of encryption keys and authentication credentials for enhanced security capabilities.

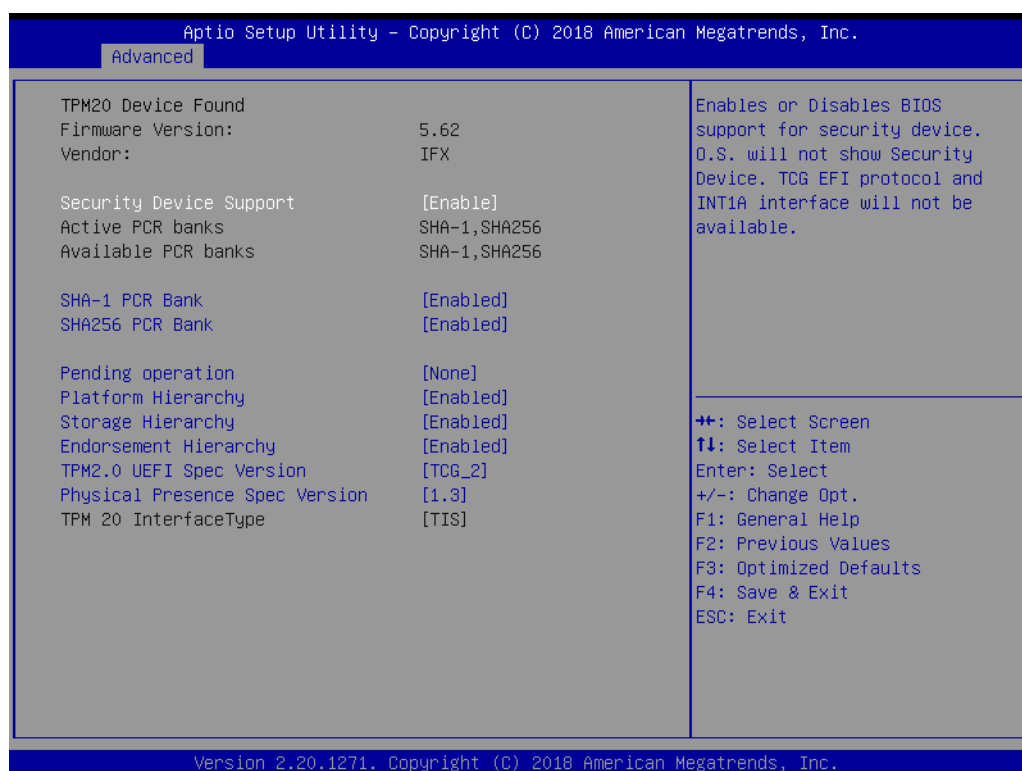

- **Security Device Support [Disable]**

Note! TCG EFI Protocol and INT1A interface won't be available.



3.2.2.2 ACPI Settings

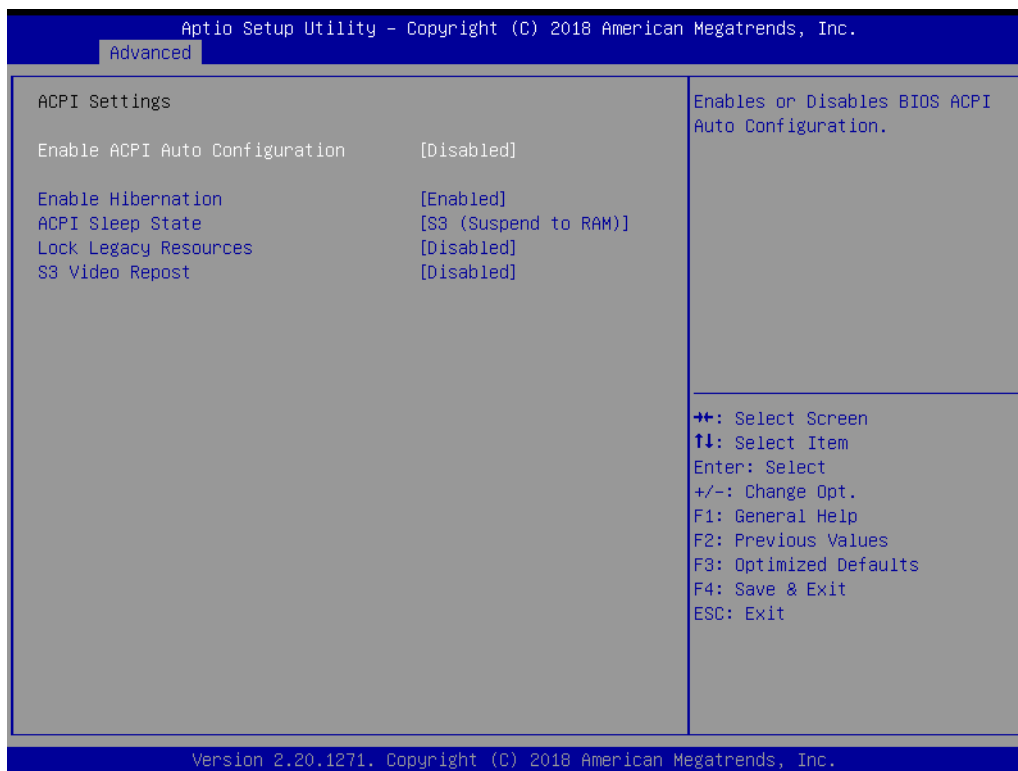

- **Enable ACPI Auto Configuration [Disabled]**
Enable or disable BIOS ACPI auto configuration.
- **Enable Hibernation [Enabled]**
Enables or Disables System ability to Hibernate (OS/S4 Sleep State). This option may be not effective with some OS.
- **ACPI Sleep State [Auto]**
Select ACPI sleep state the system will enter when the SUSPEND button is pressed.
- **Lock Legacy Resources [Disabled]**
Enables or Disables Lock of Legacy Resources.
- **S3 Video Repost [Disabled]**
Enable or Disable S3 Video Repost.

3.2.2.3 PCH Configuration

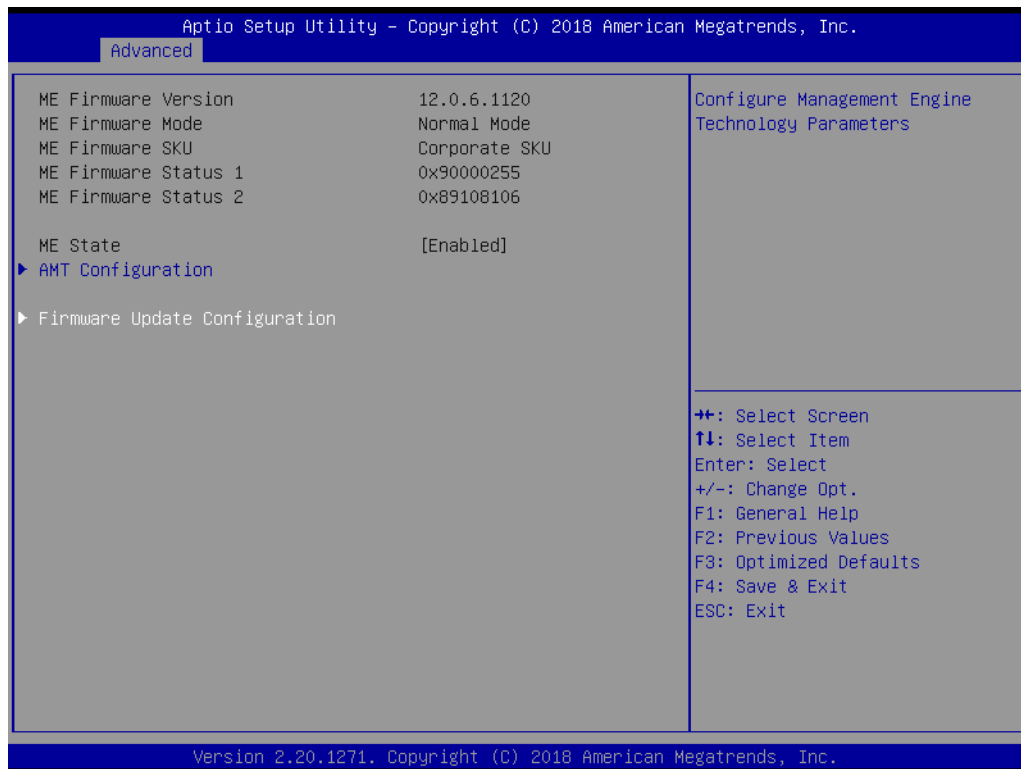

■ Firmware update Configuration

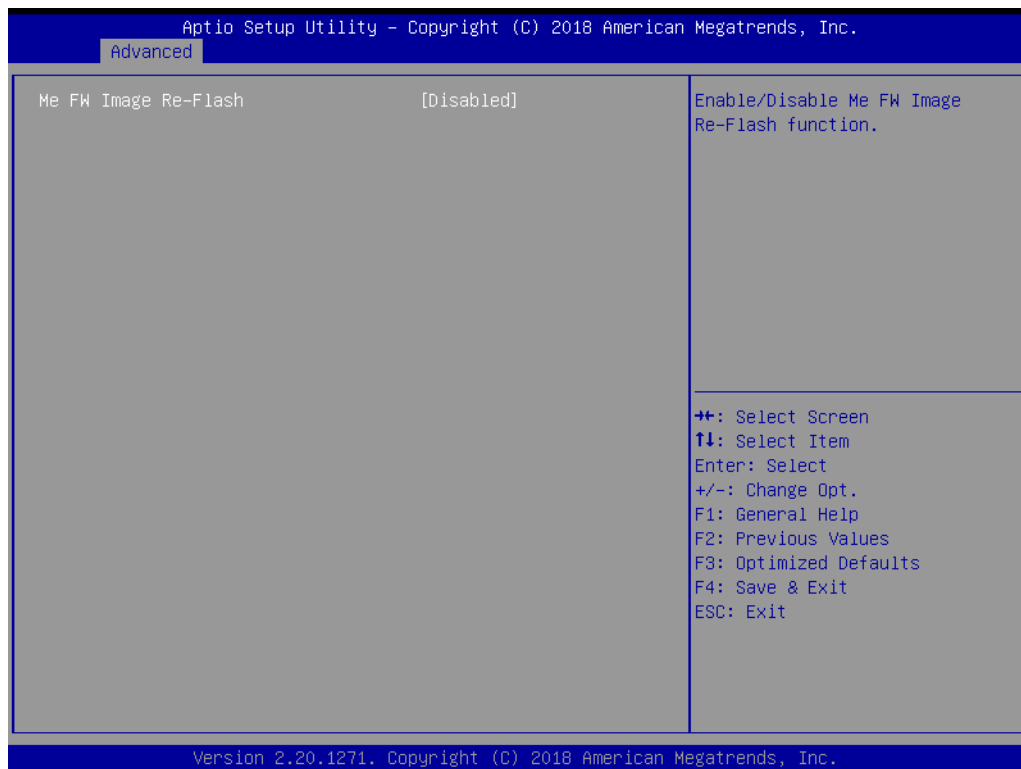

– ME FW Image Re-Flash [Disabled]

3.2.2.4 AMT Configuration

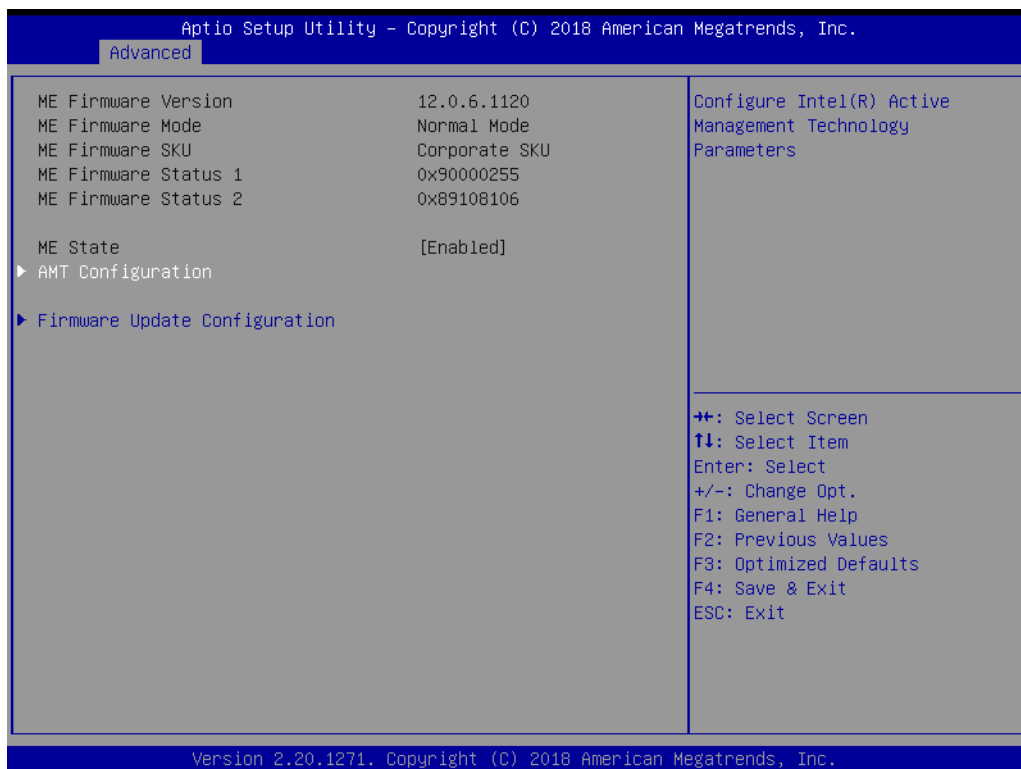

- **ASF support [Enabled]**
Enable/Disable Alert Specification Format
- **USB Provisioning of AMT [Disabled]**
- **CIRA Configuration**
 - **Active Remote Assistance Process [Disabled]**
Trigger CIRA boot.

- **ASF Configuration**
 - **PET Progress [Enable]**
User can Enable/Disable PET Events progress to receive PET events or not.
 - **Watchdog [Disabled]**
When set to [Enabled], the Watchdog timer will monitor the time taken for each task performed by a software or hardware.
 - **OS Timer [0]**
Set OS watchdog timer
 - **BIOS Timer [0]**
Set BIOS watchdog timer.
- **Secure Erase Configuration**
- **OEM Flags Settings**
- **MEBx Resolution Settings**

3.2.2.5 NCT6776 Super IO Configuration

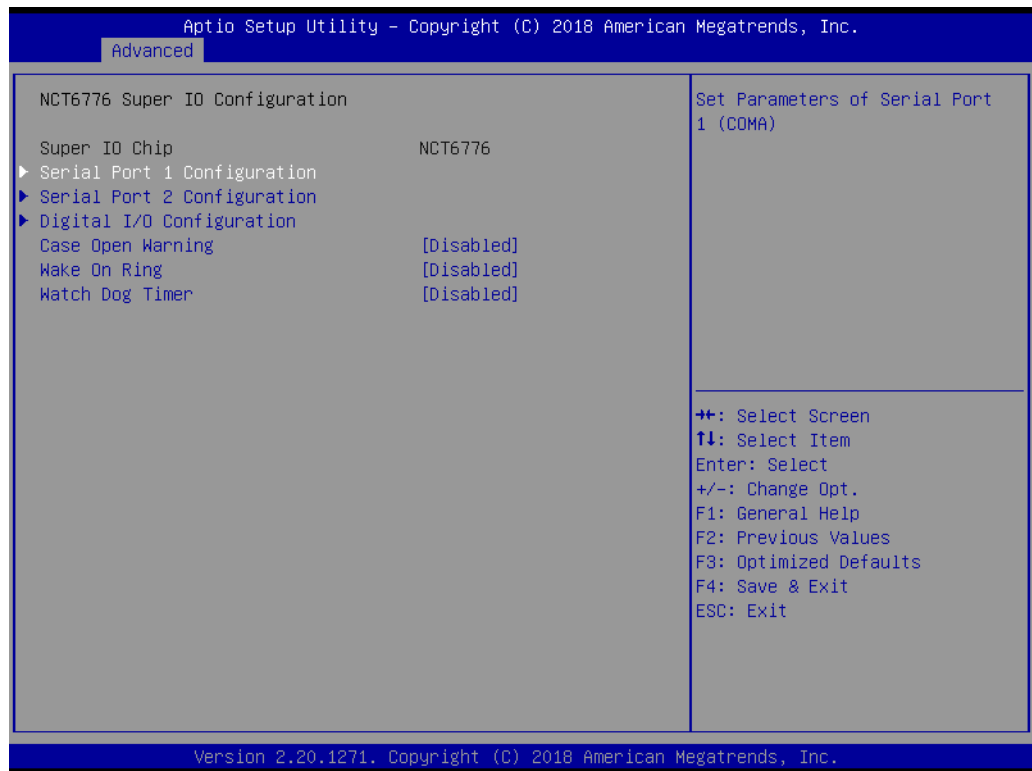

- **Super IO Chip [NCT6776]**
- **Serial Port 1 Configuration**

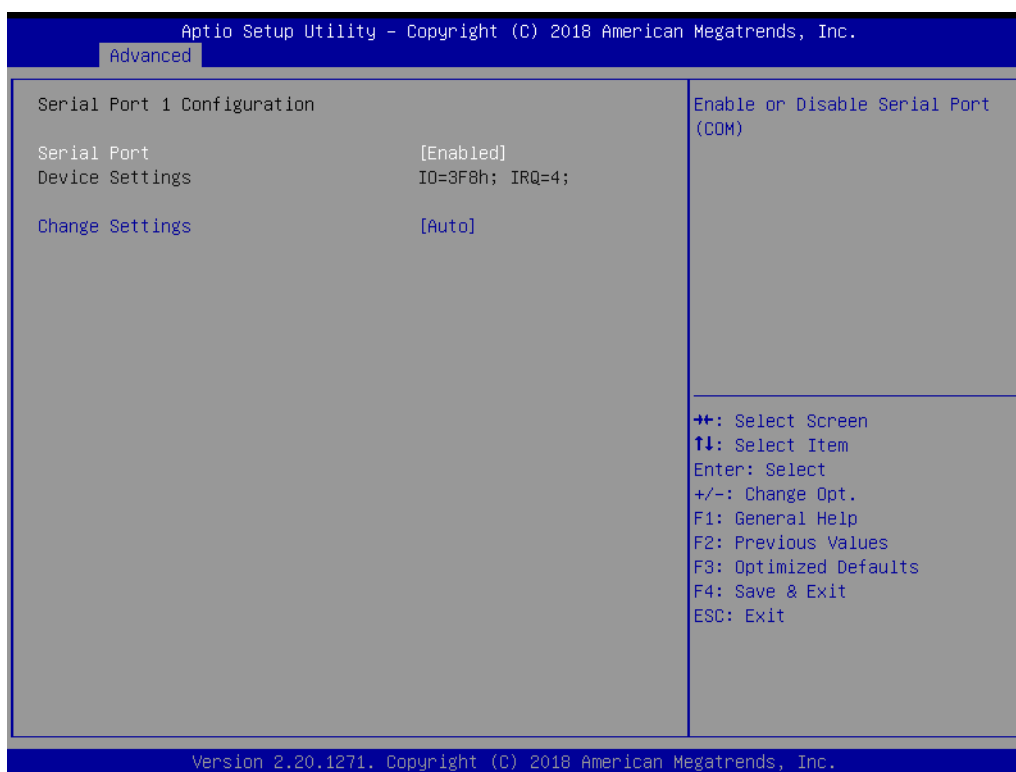

- **Serial Port [Enabled]**
 - **Device Settings: IO=3F8h; IRQ =4**
 - **Change Settings [Auto]**
To select an optimal setting for serial port 1.
- **Serial Port 2 Configuration**



- **Serial Port [Enabled]**
 - **Device Settings: IO=2F8h; IRQ =3**
 - **Change Setting [Auto]**
To select an optimal setting for serial port 2.
- **Digital I/O Configuration**

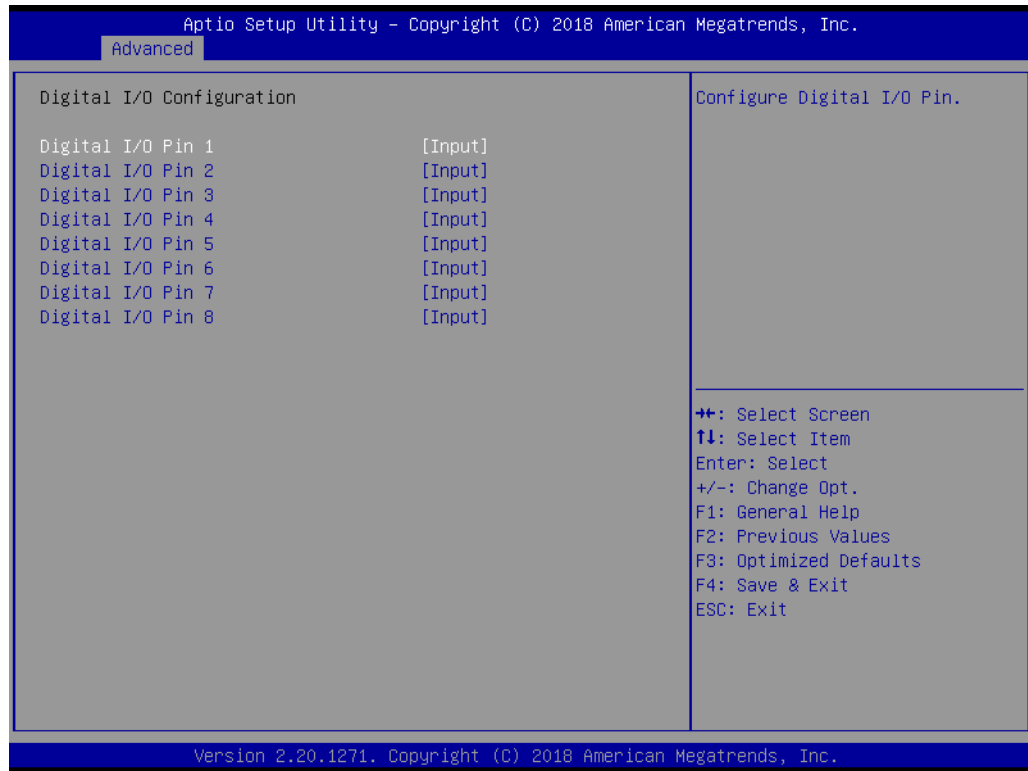

Digital I/O Pin 1 - 8 [Input]

3.2.2.6 NCT6776 HW Monitor

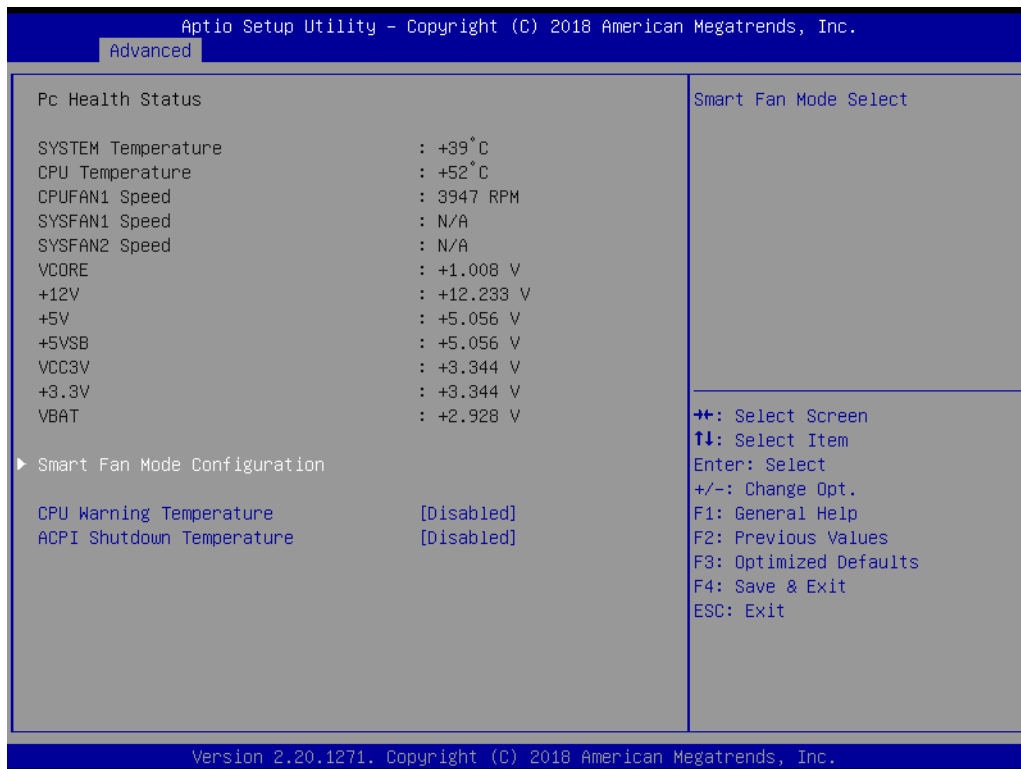

- **CPU Warning Temperature [Disabled]**
Use this to set the CPU warning temperature threshold. When the system-reaches the warning temperature, the speaker will beep.
- **ACPI Shutdown Temperature [Disabled]**
Use this to set the ACPI shutdown temperature threshold. When the system-reaches the shutdown temperature, it will be automatically shut down by ACPI OS to protect the system from overheating damage.

- **Smart Fan Mode Configuration**

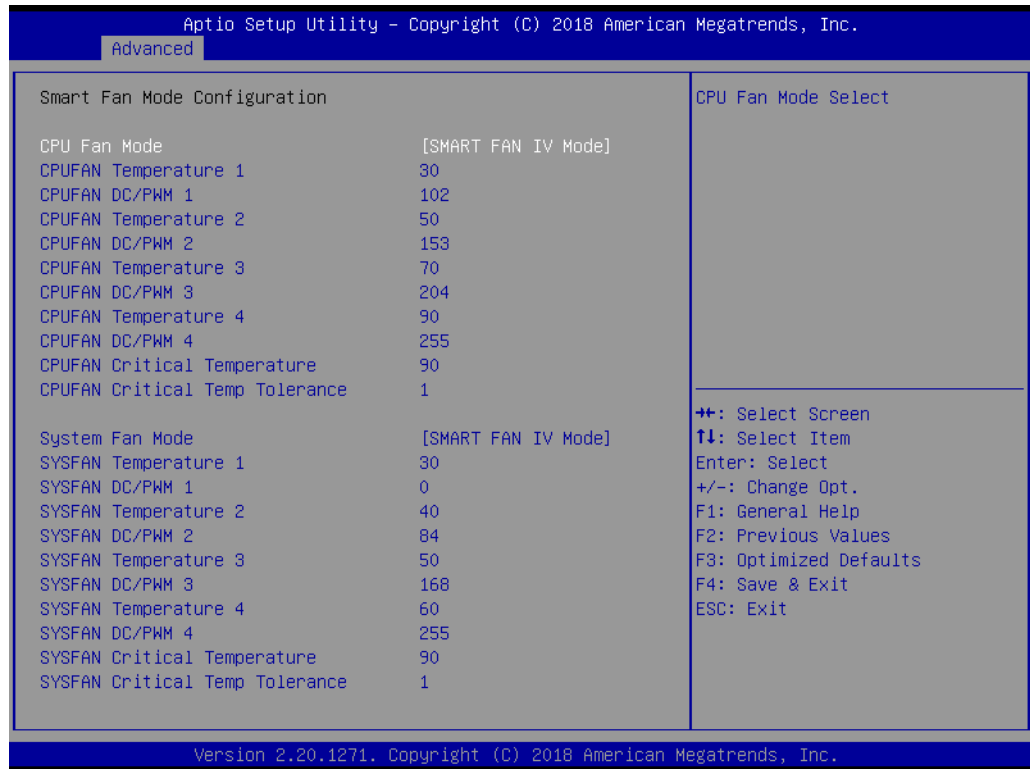

- **CPU FAN Mode [SMART FAN IV Mode]**
The item shows you CPU temperature and fan speed (PWM) information.
- **SYSFAN Mode [SMART FAN IV Mode]**
The item shows you system temperature and fan speed (PWM) information.

3.2.2.7 S5 RTC Wake Settings

The item allow you enable or disable system wake up on alarm event.

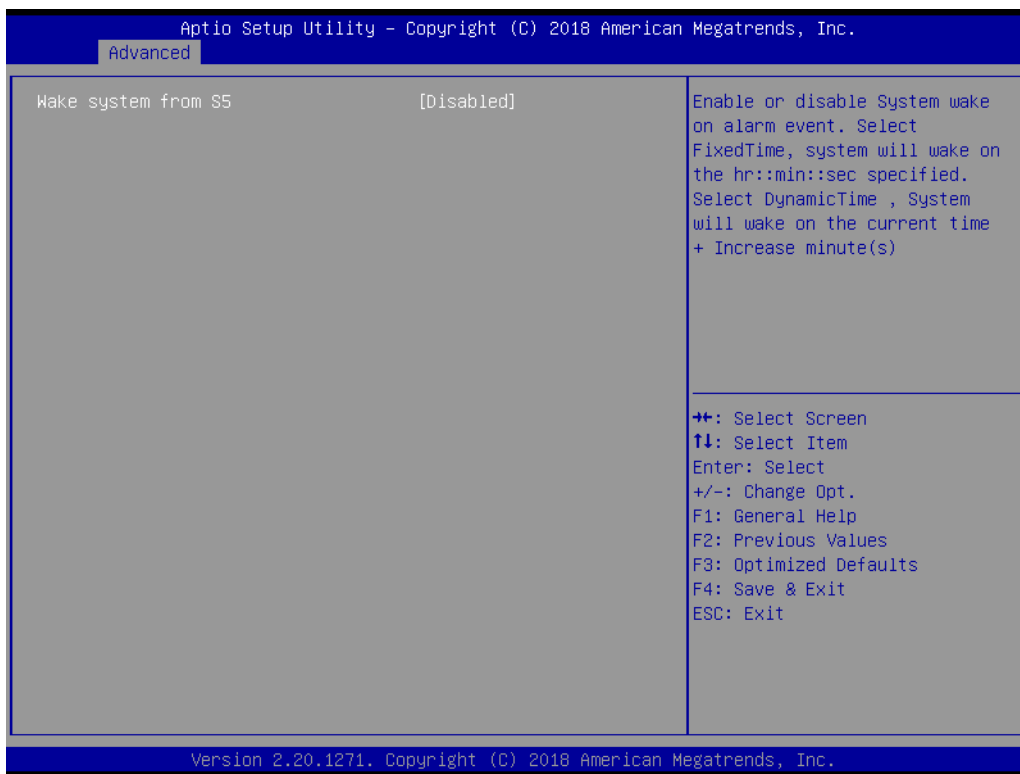

■ Wake system with Fixed Time [Disabled]

Note! When enabled, system will wake up on the specified time.



3.2.2.8 Serial Port Console Redirection

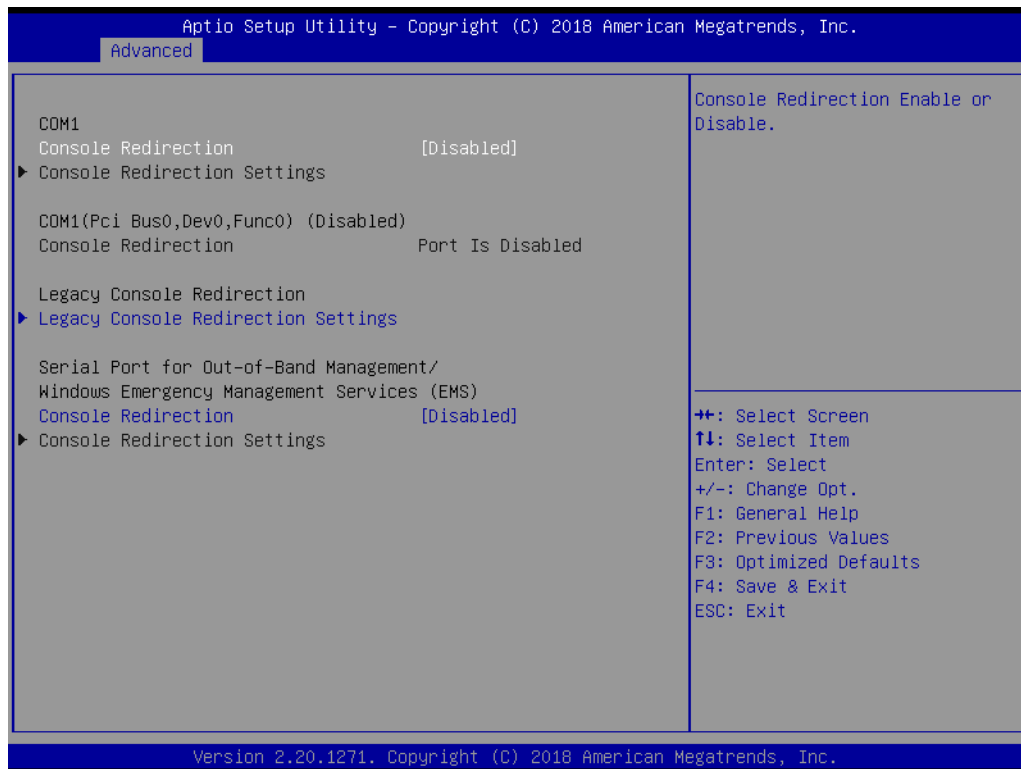

- **Console Redirection [Enabled]**
Enable or disable the console redirection feature

3.2.2.9 Network Stack Configuration [Disabled]



- **Network Stack [Disabled]**

Note! When network stack [enable]
 item must enable :LANx PXE OpROM [enable]



3.2.2.10 CSM Configuration

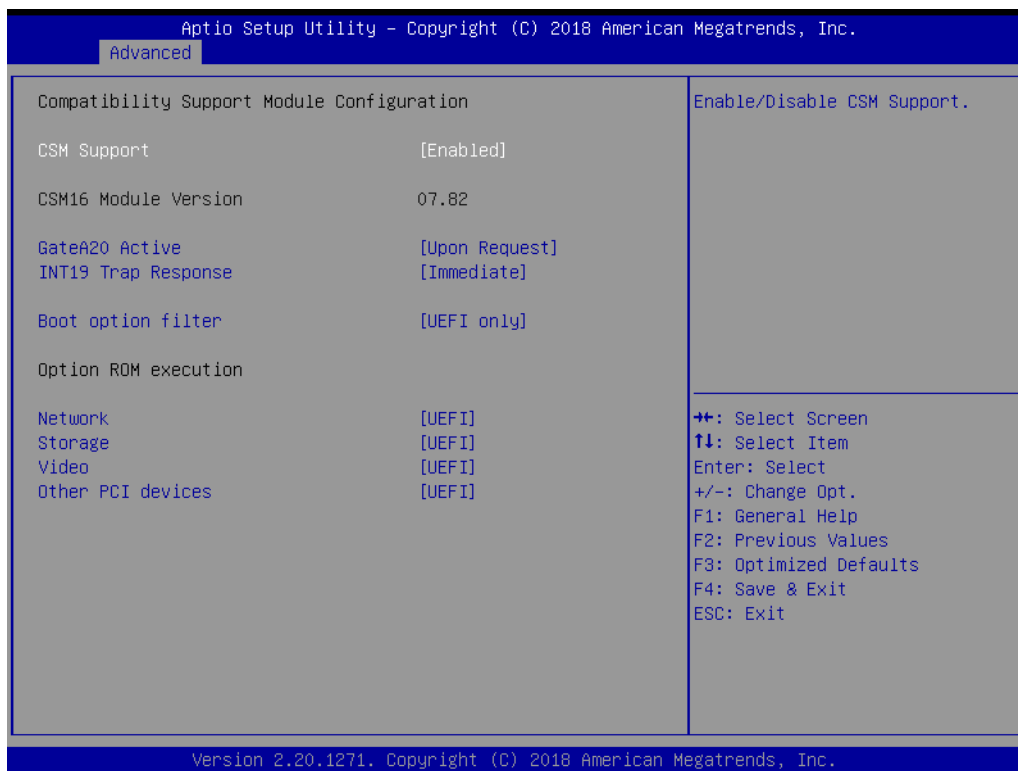

- **Boot option filter [UEFI only]**
- **Network [UEFI]**
- **Storage [UEFI]**
- **Video [UEFI]**
- **Other PCI device [UEFI]**

Note! If your HDD or other boot device is installed as Legacy mode, it may cause blue screen situation. There are 2 ways to solve this:



1. Re-install your OS as UEFI Mode
 2. Change all of settings above as " Legacy"
- * Boot option filter-> Legacy Only
 - * Network -> Legacy
 - * Storage -> Legacy
 - * Video -> Legacy
 - * Other PCI devices -> Legacy

3.2.2.11 USB Configuration

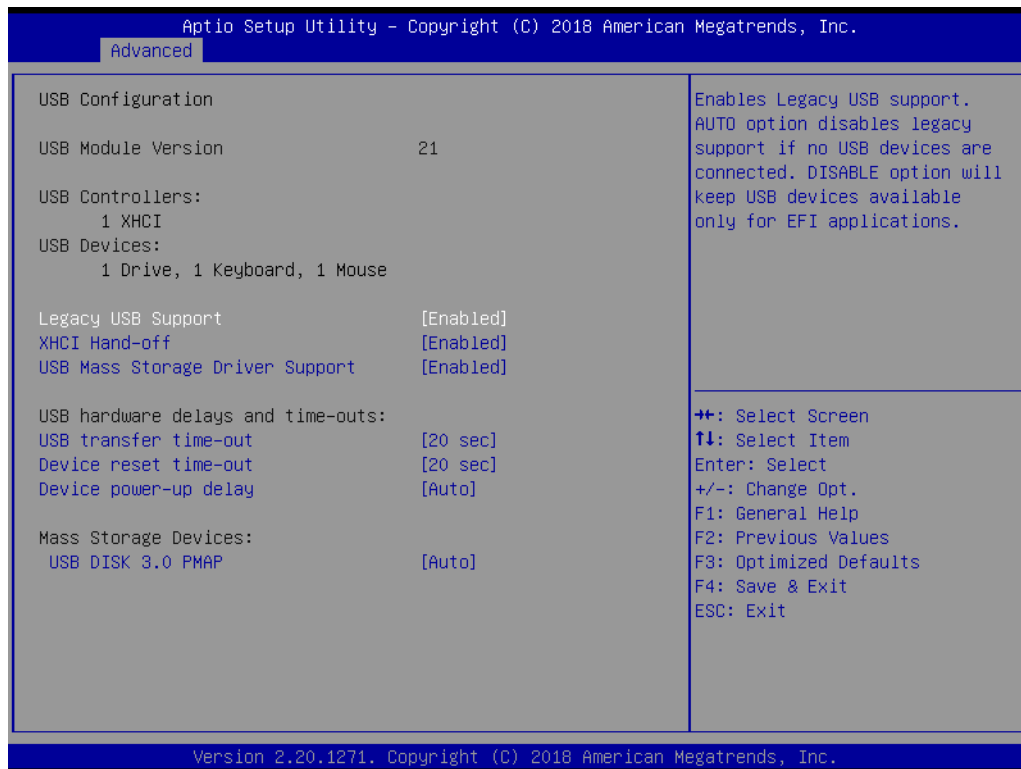

- **Legacy USB Support [Enabled]**
Enables support for legacy USB. Auto option disables legacy support if no USB devices are connected.
- **XHCI Hand-off [Enabled]**
- **USB Mass Storage Driver Support [Enabled]**
- **USB hardware delays and time-outs**
USB Device transfer & reset time-out and delay setting.
- **Mass Storage Devices [Auto]**
Shows USB mass storage device information.

3.3 Chipset Configuration Setting

Select the chipset tab from the BIOS setup screen to enter the Chipset Setup screen. Users can select any item in the left frame of the screen, such as PCI express Configuration, to go to the sub menu for that item. Users can display a Chipset Setup option by highlighting it using the <Arrow> keys. All Chipset Setup options are described in this section. The Chipset Setup screens are shown below. The sub menus are described on the following pages.



3.3.1 System Agent (SA) Configuration

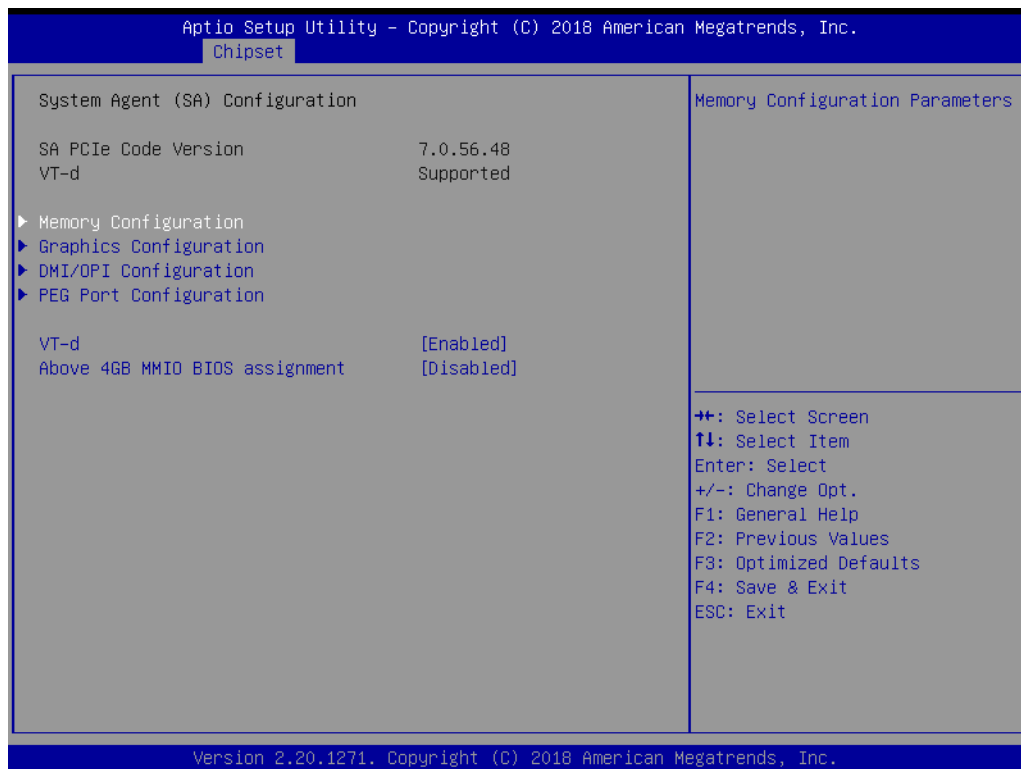

- **VT-d [Enabled]**
Disable or enable VT-d function on MCH.

3.3.1.1 Graphics Configuration

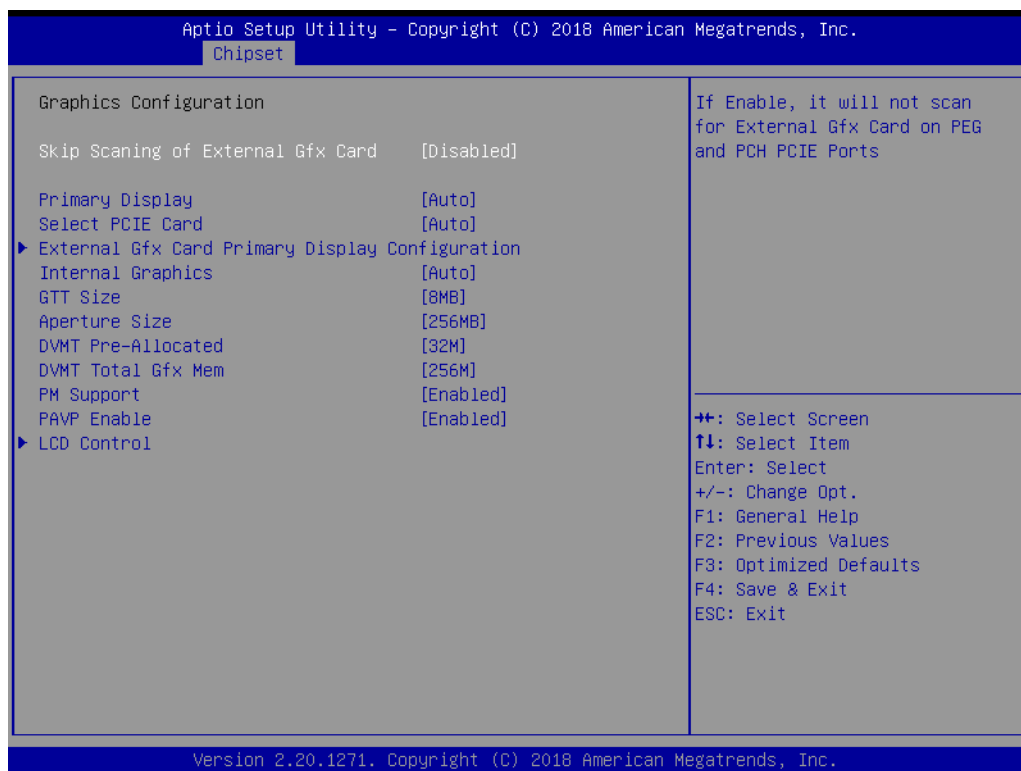

- **Skip Scanning of External Gfx Card [disabled]**
- **Primary Display [Auto]**
Select which of IGFX/PEG/PCI Graphics device should be Primary Display
- **Internal Graphics [Auto]**
Keep IGD enabled based on the setup options.
- **GTT size [8MB]**
- **Aperture Size [256MB]**
- **DVMT Pre-Allocated [32M]**
Select DVMT 5.0 Pre-Allocated (Fixed) Graphics Memory size used by the Internal Graphics Device.
- **DVMT Total Gfx Mem [256M]**
Select DVMT5.0 Total Graphic Memory size used by the Internal Graphics Device.

3.3.1.2 DMI Configuration

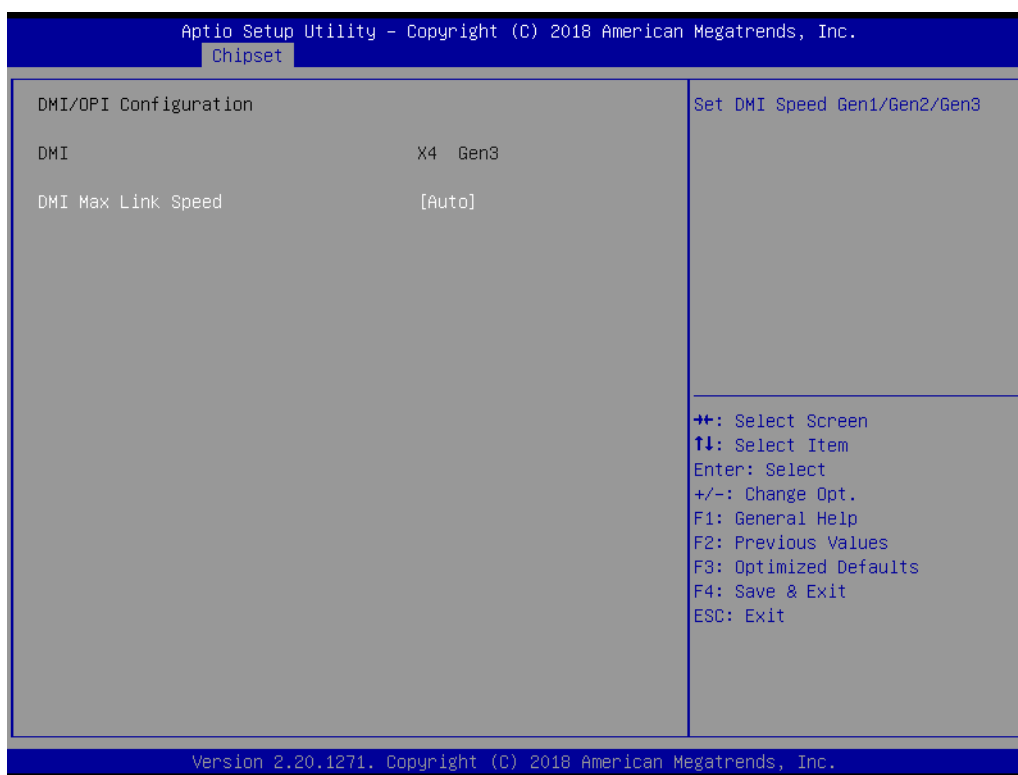

- **DMI Max Link Speed [AUTO]**

3.3.1.3 PEG Port Configuration

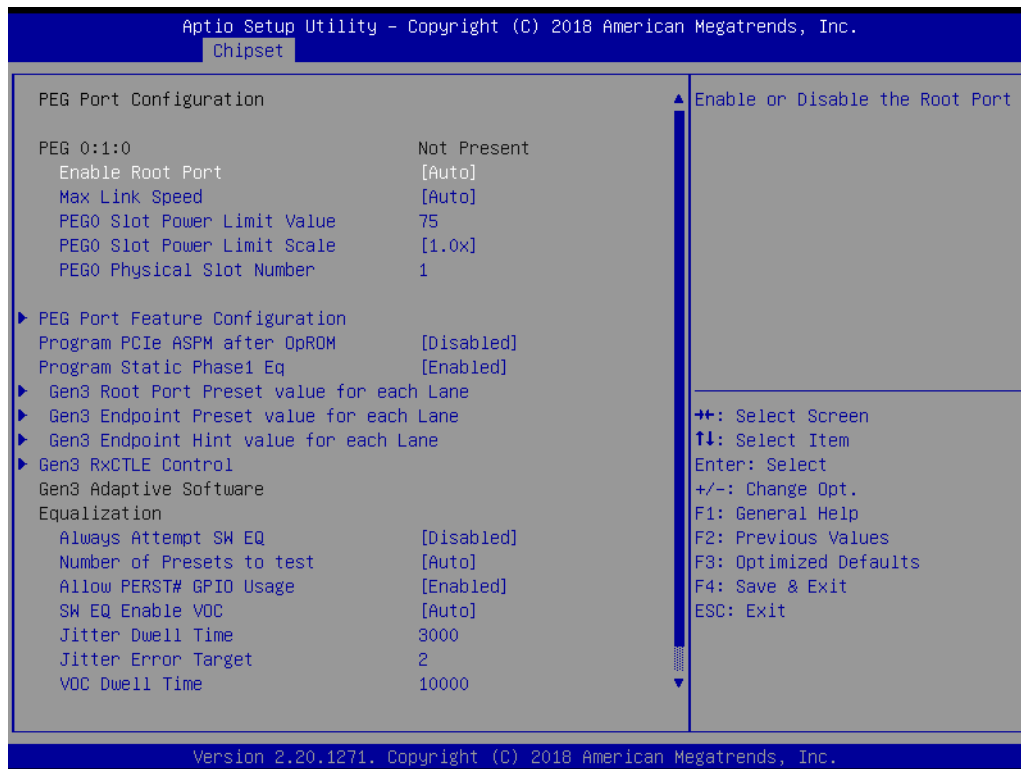

- **Enable Root Port [Auto]**
- **Max Link Speed [Auto]**
- **Program PCIe ASPM after OpROM [Disabled]**
Enabled: PCIe ASPM will be programmed after OpROM.
Disabled: PCIe ASPM will be programmed before OpROM.
- **Program Static Phase1 Eq [Enabled]**
- **PEG Gen3 Root Port Preset Value for each Lane**
Root Port Preset Value Per lane for Gen3 Equalization.
- **PEG Gen3 Endpoint Preset Value each Lane**
Endpoint Preset Value Per lane for Gen3 Equalization.
- **PEG Gen3 Endpoint Hint Value each Lane**
Endpoint Hint Value Per lane for Gen3 Equalization.

3.3.1.4 Memory Configuration

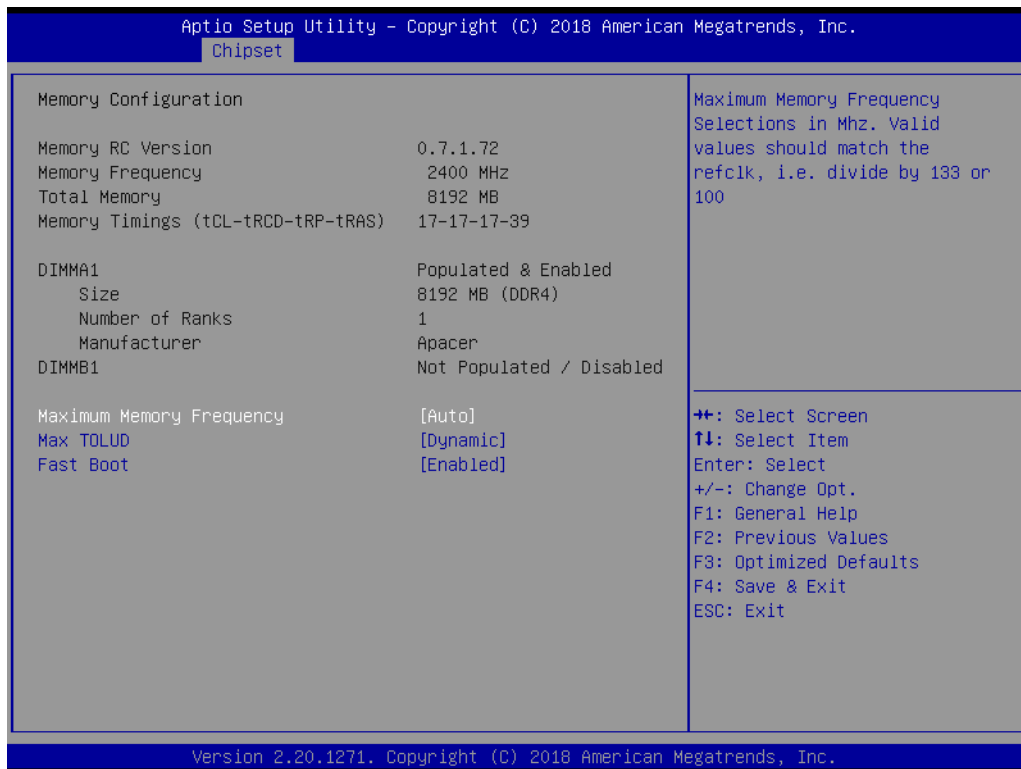

The item shows you memory specification included RC version, Frequency, size and voltage information etc.

- **Max TOLUD [Dynamic]**
Maximum Value of TOLUD. Dynamic assignment would adjust TOLUD automatically based on largest MMIO length of installed graphic controller.
- **Fast Boot [Enabled]**
Enable or disable Fast Boot support.

3.3.2 PCH-IO Configuration

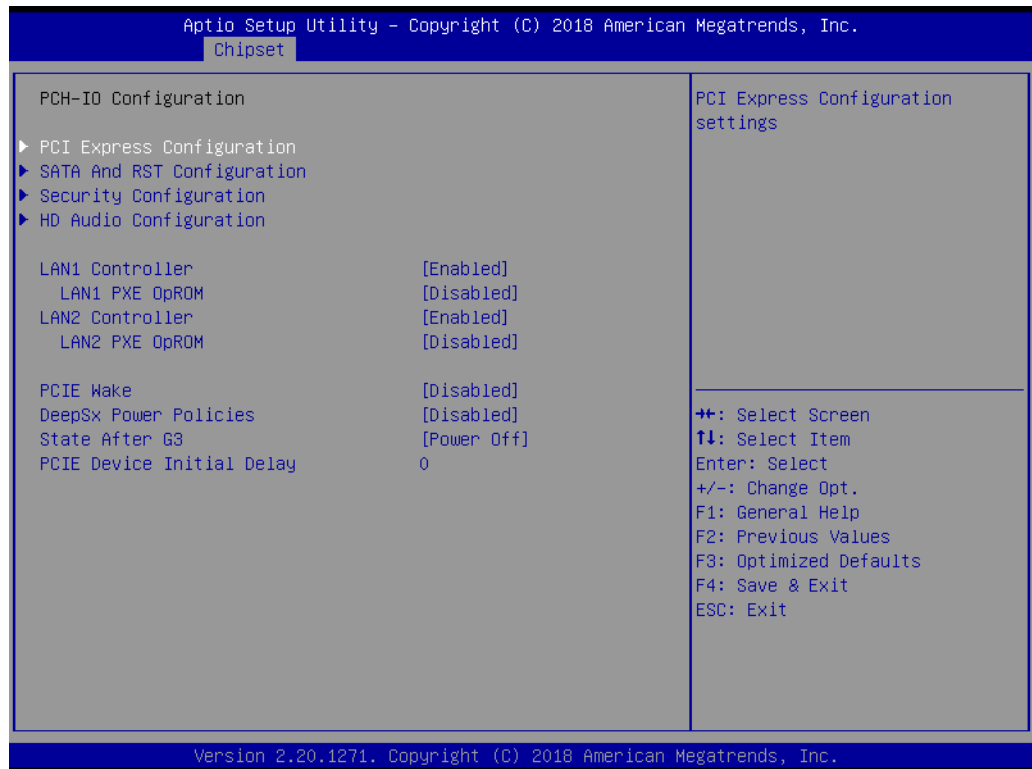

- **PCI Express Configuration**
Details of PCI Express items. (See 3.3.2.1)
- **Security Configuration**
Details of BIOS security items. (See 3.3.2.3)
- **LAN 1controller [Enabled]**
Enable or disable the LAN 1 controller.
- **LAN 2 controller [Enabled]**
Enable or disable the LAN 2 controller.
- **PCIE Wake [Disabled]**
Enable or disable PCIE to wake the system from S5.
- **State After G3 [Power Off]**
This item allows users to select off, on and last state.

3.3.2.1 PCI Express Configuration

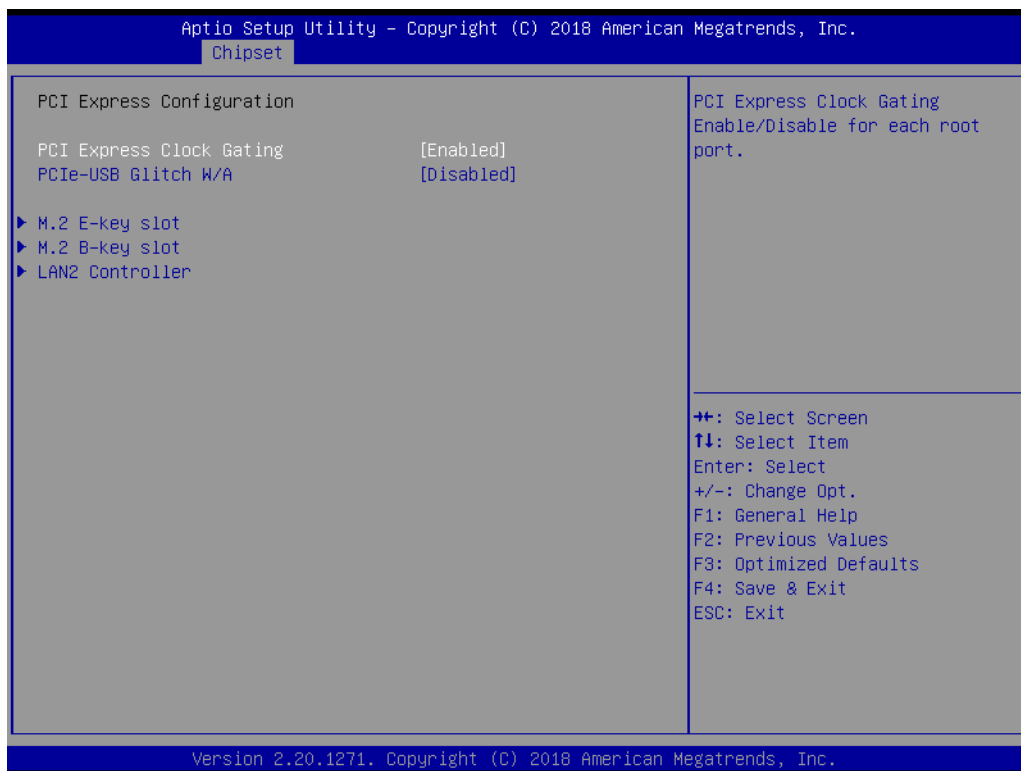

- **PCI Express Clock Gating [Enabled]**
Enable or Disable PCI Express clock gating for each port.
- **PCIe-USB Glitch W/A [Disabled]**
PCIe-USB Glitch W/A for bad USB device(s) connected behind PCIE/PEG Port.

■ M.2 E-key slot

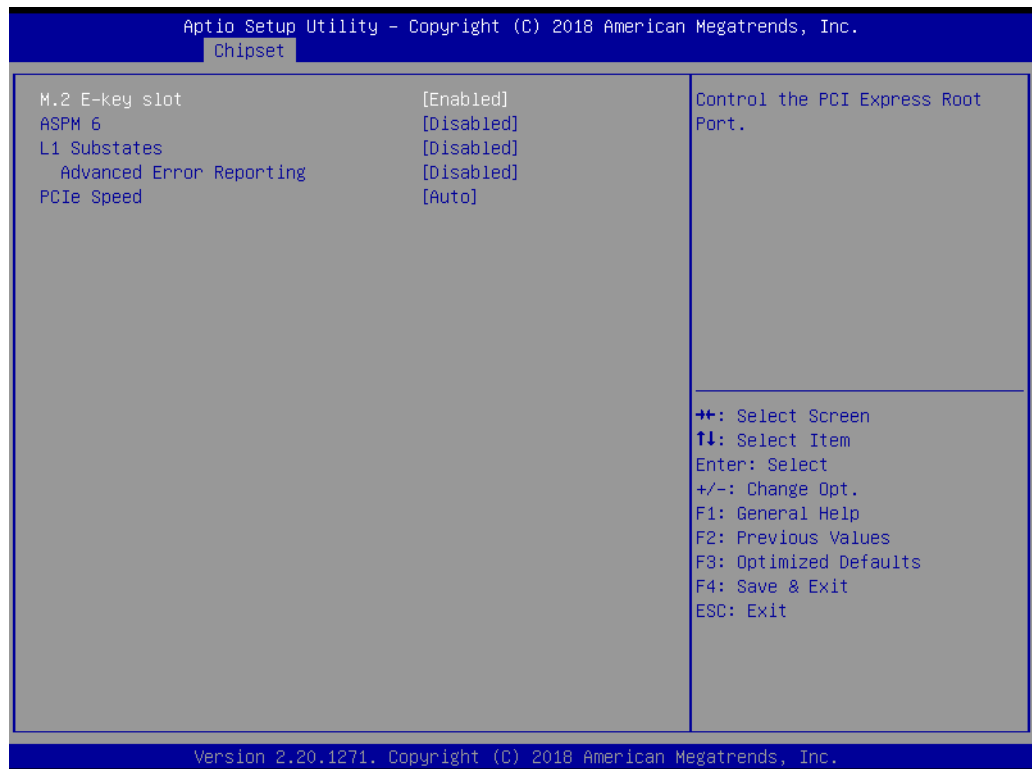

- **M.2 E-Key slot [Enabled]**
Control the M.2 E-Key Root Port.
- **ASPM 6 [Disabled]**
Set the ASPM Level: Force L0s - Force all links to L0s State : AUTO - BIOS-
auto configure : DISABLE - Disables ASPM
- **L1 Substates PCI Express L1 Substates settings [Disabled].**
- **PCIe Speed [Auto]**
Select M.2 E-Key port speed.

■ M.2 B-key slot

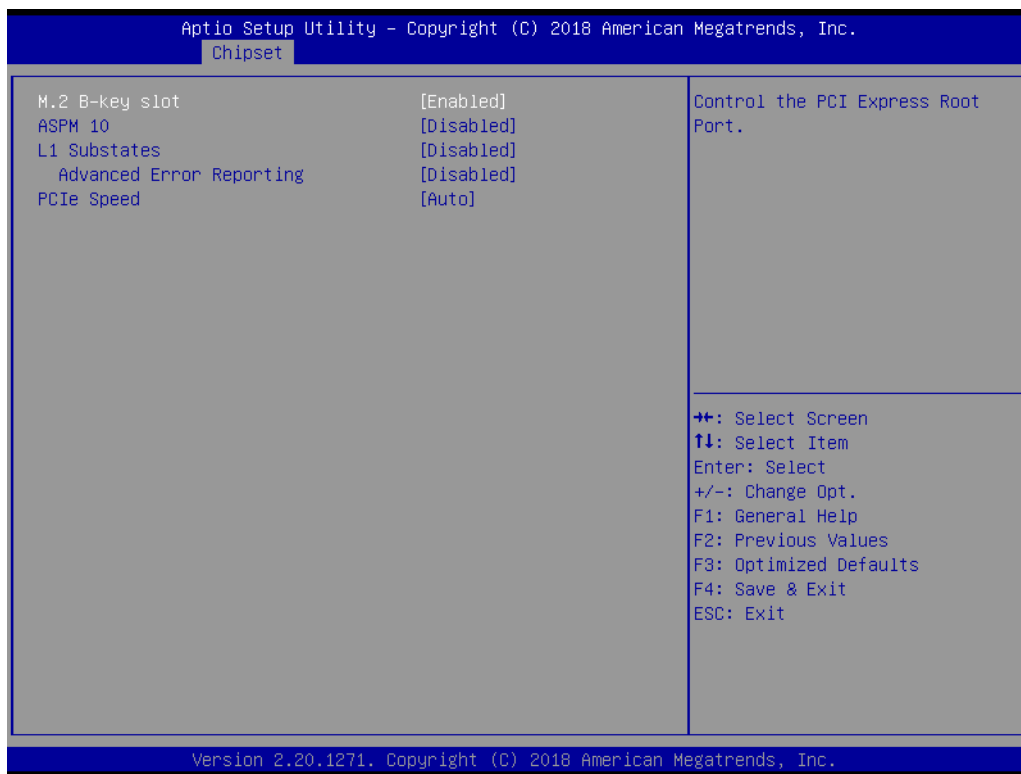

- **M.2 B-Key slot [Enabled]**
Control the M.2 B-Key Root Port.
- **ASPM Support [Disabled]**
Set the ASPM Level: Force L0s - Force all links to L0s State : AUTO - BIOS-auto configure : DISABLE - Disables ASPM
- **L1 Substates PCI Express L1 Substates settings [Disabled].**
- **PCIe Speed [Auto]**
Select M.2 B-Key port speed.

■ LAN2 Controller



- **LAN2 Controller [Enabled]**
Control the LAN2 controller Root Port.
- **ASPM Support [Disabled]**
Set the ASPM Level: Force L0s - Force all links to L0s State : AUTO - BIOS-
auto configure : DISABLE - Disables ASPM
- **L1 Substates PCI Express L1 Substates settings [Disabled].**
- **PCIe Speed [Auto]**
Select M.2 B-Key port speed.

3.3.2.2 SATA and RST Configuration

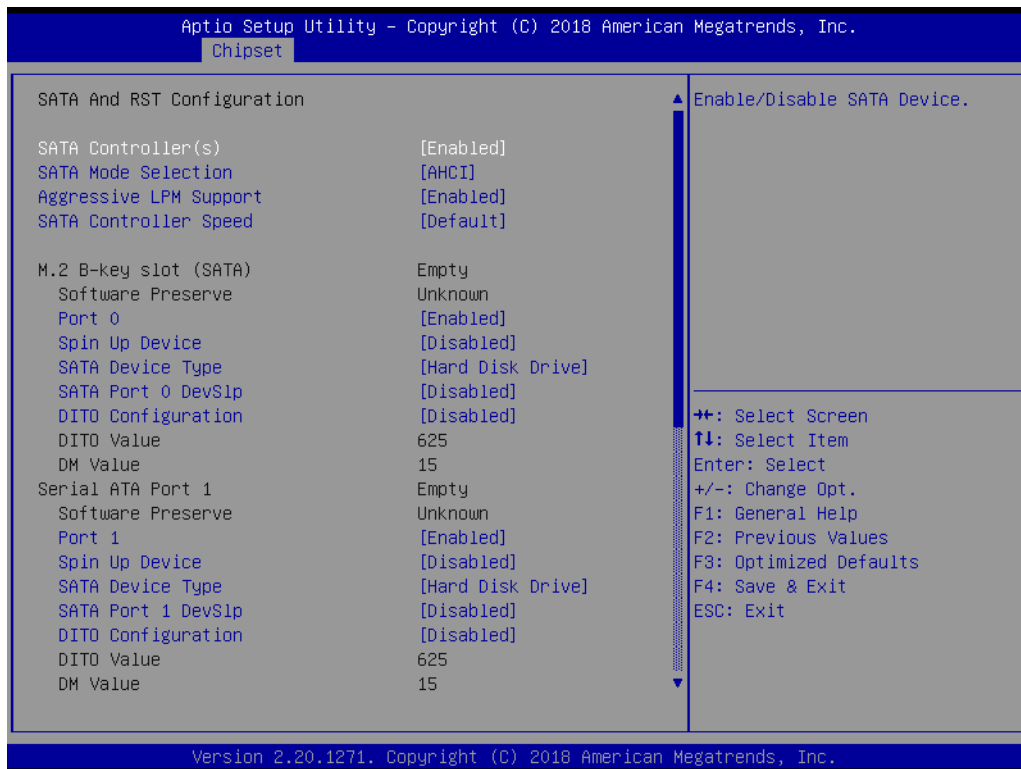

3.4 Security Setting



- **Administrator Password**
Select this option and press <ENTER> to access the sub menu, and then type in the password. Set the Administrator password.
- **User Password**
Select this option and press <ENTER> to access the sub menu, and then type in the password. Set the User Password.

3.5 Boot Setting

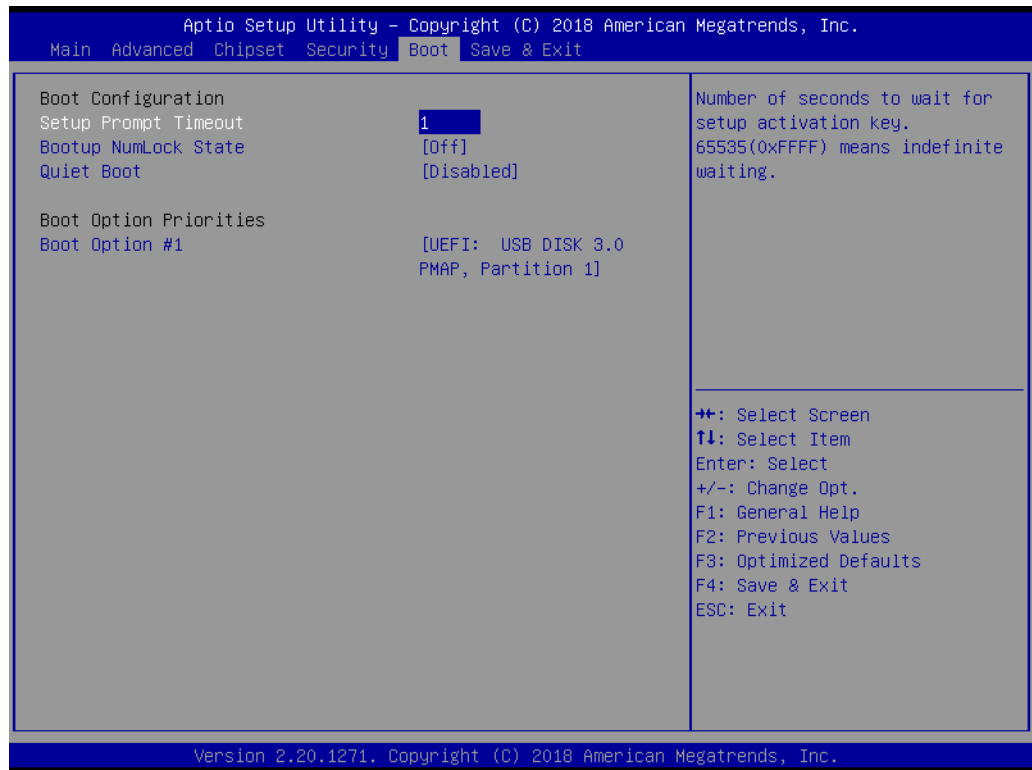

- **Setup Prompt Timeout**
User the <+> and <-> keys to adjust the number of seconds to wait for setup activation key.
- **Bootup NumLock State [On]**
On or Off power on state for the NumLock
- **Quiet Boot [Disabled]**
If this option is set to disabled, the BIOS displays normal POST messages. If enabled, an OEM logo is shown instead of POST messages.
- **Boot Option #1/#2**
Choose boot priority from boot device

3.6 Save & Exit Configuration

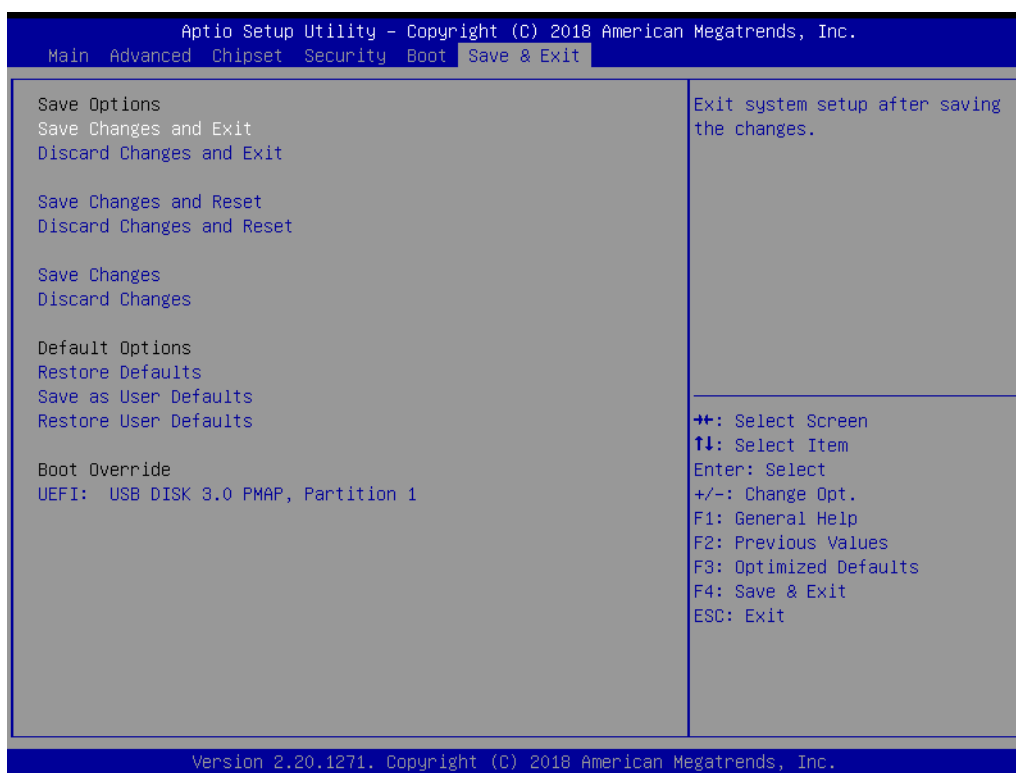

■ Save Changes and Exit

When users have completed system configuration, select this option to save changes, exit BIOS setup menu and reboot the computer to take effect all system configuration parameters.

1. Select Exit Saving Changes from the Exit menu and press <Enter>. The following message appears: Save Configuration Changes and Exit Now? [Ok] [Cancel]
2. Select [Ok] or [Cancel]

■ Discard Changes and Exit

Select this option to quit Setup without making any permanent changes to the system configuration.

1. Select Exit Discarding Changes from the Exit menu and press <Enter>. The following message appears: Discard Changes and Exit Setup Now? [Ok] or [Cancel]
2. Select Ok to discard changes and exit. Discard Changes Select Discard Changes from the Exit menu and press <Enter>.

■ Save Changes and Reset

When users have completed system configuration, select this option to save changes, exit BIOS setup menu and reboot the computer to take effect all system configuration parameters.

1. Select Exit Saving Changes from the Exit menu and press <Enter>. The following message appears: Save Configuration Changes and Exit Now? [Ok] or [Cancel]
2. Select [Ok] or [Cancel]

■ Discard Changes and Reset

Select this option to quit Setup without making any permanent changes to the system configuration.

1. Select Reset Discarding Changes from the Exit menu and press <Enter>. The following message appears: Discard Changes and Exit Setup Now? [Ok] or [Cancel]
2. Select Ok to discard changes and reset. Discard Changes Select Discard Changes from the Exit menu and press <Enter>.

■ **Restore Default**

The BIOS automatically configures all setup items to optimal settings when users select this option. Defaults are designed for maximum system performance, but may not work best for all computer applications. In particular, do not use the Defaults if the user's computer is experiencing system configuration problems. Select Restore Defaults from the Exit menu and press <Enter>.

■ **Save as User Default**

Save the all current settings as a user default.

■ **Restore User Default**

Restore all settings to user default values.

Chapter 4

Software Introduction
& Service

4.1 Introduction

The mission of Advantech Embedded Software Services is to "Enhance quality of life with Advantech platforms and Microsoft® Windows® embedded technology." We enable Windows® Embedded software products on Advantech platforms to more effectively support the embedded computing community. Customers are freed from the hassle of dealing with multiple vendors (hardware suppliers, system integrators, embedded OS distributors) for projects. Our goal is to make Windows® Embedded Software solutions easily and widely available to the embedded computing community.

4.2 Value-Added Software Services

Software API: An interface that defines the ways by which an application program may request services from libraries and/or operating systems. Provides not only the underlying drivers required but also a rich set of user-friendly, intelligent and integrated interfaces, which speeds development, enhances security and offers add-on value for Advantech platforms. It plays the role of catalyst between developer and solution, and makes Advantech embedded platforms easier and simpler to adopt and operate with customer applications.

4.2.1 Software API

4.2.1.1 Control

GPIO



General Purpose Input/Output is a flexible parallel interface that allows a variety of custom connections. It allows users to monitor the level of signal input or set the output status to switch on/off the device. Our API also provide Programmable GPIO, which allows developers to dynamically set the GPIO input or output status.

SMBus



SMBus is the System Management Bus defined by Intel Corporation in 1995. It is used in personal computers and servers for low-speed system management communications. The SMBus API allows a developer to interface a embedded system environment and transfer serial messages using the SMBus protocols, allowing multiple simultaneous device control.

4.2.1.2 Display

Brightness Control



The Brightness Control API allows a developer to access embedded devices and easily control brightness.

Backlight



The Backlight API allows a developer to control the backlight (screen) on/off in embedded devices.

4.2.1.3 Monitor

Watchdog



A watchdog timer (WDT) is a device that performs a specific operation after a certain period of time if something goes wrong and the system does not recover on its own. A watchdog timer can be programmed to perform a warm boot (restarting the system) after a certain number of seconds.

Hardware Monitor



The Hardware Monitor (HWM) API is a system health supervision API that inspects certain condition indexes, such as fan speed, temperature and voltage.

4.2.1.4 Power Saving

CPU Speed



Makes use of Intel SpeedStep technology to save power consumption. The system will automatically adjust the CPU speed depending on the system loading.

System Throttling

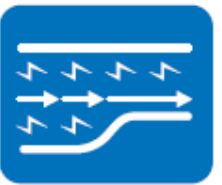

Refers to a series of methods for reducing power consumption in computers by lowering the clock frequency. This API allows the user to adjust the clock from 87.5% to 12.5%.

4.2.2 Software Utility

BIOS Flash

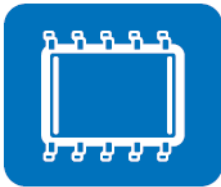

The BIOS Flash utility allows customers to update the flash ROM BIOS version, or use it to back up current BIOS by copying it from the flash chip to a file on customers' disk. The BIOS Flash utility also provides a command line version and an API for fast implementation into customized applications.

Embedded Security ID



The embedded application is the most important property of a system integrator. It contains valuable intellectual property, design knowledge and innovation, but it is easy to copy! Embedded Security ID utility provides reliable security functions for customers to secure their application data within the embedded BIOS.

Monitoring



The Monitoring is a utility for customer to monitor the system health, like voltage, CPU and system temperature and fan speed. These items are important to a device, if the critical errors occur and are not solved immediately, permanent damage may be caused.

eSOS



The eSOS is a small OS stored in BIOS ROM. It will boot up in case of a main OS crash. It will diagnose the hardware status, and then send an e-mail to the designated administrator. The eSOS also provide for remote connection via Telnet server and FTP server so the administrator can attempt to rescue the system. Note: This function requires BIOS customization.

Chapter 5

Chipset Software
Installation Utility

5.1 Before You Begin

To facilitate the installation of the enhanced display drivers and utility software, read the instructions in this chapter carefully. The drivers for the AIMB-276 are located on Advantech support website: <http://support.advantech.com/Support/>. The driver on the support website will guide and link you to the utilities and drivers under a Windows system. Updates are provided via Service Packs from Microsoft*.

Note! *The driver files on the website are compressed. Do not attempt to install the drivers by copying the files manually. You must download the files and decompress them first. Also, please use the supplied SETUP program to install the drivers.*



Before you begin, it is important to note that most display drivers need to have the relevant software application already installed in the system prior to installing the enhanced display drivers. In addition, many of the installation procedures assume that you are familiar with both the relevant software applications and operating system commands. Review the relevant operating system commands and the pertinent sections of your application software's user manual before performing the installation.

5.2 Introduction

The Intel® Chipset Software Installation (CSI) utility installs the Windows INF files that outline to the operating system how the chipset components will be configured. This is needed for the proper functioning of the following features:

- Core PCI PnP services
- Serial ATA interface support
- USB support
- Identification of Intel® chipset components in the Device Manager

Note! *This utility is used for the following versions of Windows, and it has to be installed before installing all the other drivers:*



- Windows 7 (32-bit)
- Windows 7 (64-bit)
- Windows 8 (64-bit)
- Windows 10 (64 bit)

5.3 Windows 10 Driver Setup

When enter the website of Advantech, then search product AIMB-276. There is "Chipset" driver inside.

Win 10(64bits) Driver for AIMB-276

Solution : Win 10(64bits) Driver for AIMB-276

Download File	Released Date	Download Site	
AIMB-276_Audio_Win10(64bits).zip	2018-11-23	Primary	Secondary
AIMB-276_Graphic_Win10(64bits).zip	2018-11-23	Primary	Secondary
AIMB-276_Chip_Win10(64bits).zip	2018-11-23	Primary	Secondary
AIMB-276_Intel RAID_AHCI_Win10(64bits).zip	2018-11-23	Primary	Secondary
AIMB-276_Intel Serial IO_Win10(64bits).zip	2018-11-23	Primary	Secondary
AIMB-276_LAN_Win10(64bits).zip	2018-11-23	Primary	Secondary

Chapter 6

VGA Setup

6.1 Introduction

The 6th Gen Intel Core i processors are embedded with an integrated graphics controller. You need to install the VGA driver to enable the function.

Optimized integrated graphic solution: With Intel Graphics Flexible, it supports versatile display options and 32-bit 3D graphics engine. Dual independent display, enhanced display modes for widescreen flat panels for extend, twin, and clone dual display mode, and optimized 3D support deliver an intensive and realistic visual experience.

6.2 Windows 10

Note! *Before installing this driver, make sure the CSI utility has been installed in your system. See Chapter 5 for information on installing the CSI utility.*



When enter the website of Advantech, then search product AIMB-276. There is "Graphic" driver inside.

[Support](#) / [Downloads](#) / [Driver](#) /

Document No. 1-3609082897			
Date Updated	11-23-2018	Date Created	11-23-2018
Document Type	Driver	Related OS	
Related Product	AIMB-276		

Win 10(64bits) Driver for AIMB-276

Solution : Win 10(64bits) Driver for AIMB-276

Download File	Released Date	Download Site	
AIMB-276_Audio_Win10(64bits).zip	2018-11-23	Primary	Secondary
AIMB-276_Graphic_Win10(64bits).zip	2018-11-23	Primary	Secondary
AIMB-276_Chip_Win10(64bits).zip	2018-11-23	Primary	Secondary
AIMB-276_Intel RAID_AHCI_Win10(64bits).zip	2018-11-23	Primary	Secondary
AIMB-276_Intel Serial IO_Win10(64bits).zip	2018-11-23	Primary	Secondary
AIMB-276_LAN_Win10(64bits).zip	2018-11-23	Primary	Secondary

Chapter 7

LAN Configuration

7.1 Introduction

The AIMB-276 has dual Gigabit Ethernet LANs via dedicated PCI Express x1 lanes (Intel I219LM (LAN1) and I211AT (LAN2)) that offer bandwidth of up to 500 MB/sec, eliminating the bottleneck of network data flow and incorporating Gigabit Ethernet at 1000 Mbps.

7.2 Features

- Integrated 10/100/1000 Mbps transceiver
- 10/100/1000 Mbps triple-speed MAC
- High-speed RISC core with 24-KB cache
- On-chip voltage regulation
- Wake-on-LAN (WOL) support
- PCI Express X1 host interface

7.3 Installation

Note! *Before installing the LAN drivers, make sure the CSI utility has been installed on your system. See Chapter 5 for information on installing the CSI utility.*



The AIMB-276's Intel I219LM (LAN1) and I211AT (LAN2) Gigabit integrated controllers support all major network operating systems. However, the installation procedure varies from system to system. Please find and use the section that provides the driver setup procedure for the operating system you are using.

7.4 Windows 10 Driver Setup

When enter the website of Advantech, then search product AIMB-276. There is "LAN" driver inside.

[Support](#) / [Downloads](#) / [Driver](#) /

Document No. 1-3609082897			
Date Updated	11-23-2018	Date Created	11-23-2018
Document Type	Driver	Related OS	
Related Product	AIMB-276		

Win 10(64bits) Driver for AIMB-276

Solution : Win 10(64bits) Driver for AIMB-276

Download File	Released Date	Download Site	
AIMB-276_Audio_Win10(64bits).zip	2018-11-23	Primary	Secondary
AIMB-276_Graphic_Win10(64bits).zip	2018-11-23	Primary	Secondary
AIMB-276_Chip_Win10(64bits).zip	2018-11-23	Primary	Secondary
AIMB-276_Intel RAID_AHCI_Win10(64bits).zip	2018-11-23	Primary	Secondary
AIMB-276_Intel Serial IO_Win10(64bits).zip	2018-11-23	Primary	Secondary
AIMB-276_LAN_Win10(64bits).zip	2018-11-23	Primary	Secondary

Appendix **A**

I/O Pin Assignments

A.1 Direct Current input connector (DCIN1)

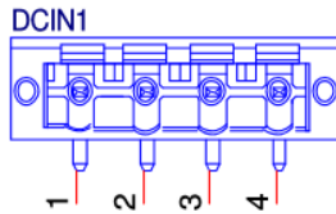

Pin	Signal
1	GND
2	+VDCIN_ADP_IN
3	+VDCIN_ADP_IN
4	GND

A.2 DisplayPort1/2 (DP12)

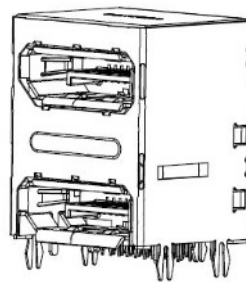

Pin	Signal	Pin	Signal
1	DP1_0+	11	GND
2	GND	12	DP1_3-
3	DP1_0-	13	DP1_AUX_EN#
4	DP1_1+	14	GND
5	GND	15	DP1_AUX+
6	DP1_1-	16	GND
7	GND	17	DP1_AUX-
8	GND	18	DP1_HPD
9	DP1_2-	19	GND
10	DP1_3+	20	+V3.3_DP
Pin	Signal	Pin	Signal
21	DP2_0+	31	GND
22	GND	32	DP2_3-
23	DP2_0-	33	DP2_AUX_EN#
24	DP2_1+	34	GND
25	GND	35	DP2_AUX+
26	DP2_1-	36	GND
27	DP2_2+	37	DP2_AUX-
28	GND	38	DP2_HPD

29	DP2_2-	39	GND
30	DP2_3+	40	+V3.3_DP

A.3 High-Definition Multimedia Interface connector (HDMI1)



Pin	Signal	Pin	Signal
A1	HDMI1_z_D2+	A11	GND
A2	GND	A12	HDMI1_z_CLK-
A3	HDMI1_z_D2-	A13	NC
A4	HDMI1_z_D1+	A14	NC
A5	GND	A15	HDMI1_SCL
A6	HDMI1_z_D1-	A16	HDMI1_SDA
A7	HDMI1_z_D0+	A17	GND
A8	GND	A18	+V5_HDMI
A9	HDMI1_z_D0-	A19	HDMI1_HPD
A10	HDMI1_z_CLK+		

A.4 Universal Serial Bus Port 3.1 Gen1 #7/ #8 (USB78)

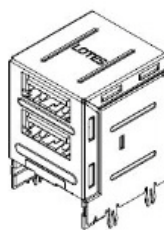

Pin	Signal	Pin	Signal
B11	+USB2V78	B21	+USB2V78
B12	USB_D7-	B22	USB_D8-
B13	USB_D7+	B23	USB_D8+
B14	GND	B24	GND
B15	USB3X7_z_RX-	B25	USB3X8_z_RX-
B16	USB3X7_z_RX+	B26	USB3X8_z_RX+
B17	GND	B27	GND
B18	USB3X7_z_TX-	B28	USB3X8_z_TX-

A.5 Universal Serial Bus Port 3.1 Gen2 #1/ #2 (USB12)

A.6 RJ45 #1(LAN1)

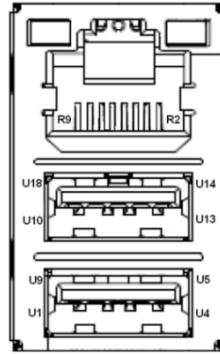

Pin	Signal	Pin	Signal
U1	+USBV1	U10	+USBV1
U2	USB_D1-	U11	USB_D2-
U3	USB_D1+	U12	USB_D2+
U4	GND	U13	GND
U5	USB31X1_z_RX-	U14	USB31X2_z_RX-
U6	USB31X1_z_RX+	U15	USB31X2_z_RX+
U7	GND	U16	GND
U8	USB31X1_z_TX-	U17	USB31X2_z_TX-
U9	USB31X1_z_TX+	U18	USB31X2_z_TX+
Pin	Signal	Pin	Signal
R2	MDI_LAN1_DP0	R6	MDI_LAN1_DP2
R3	MDI_LAN1_DN0	R7	MDI_LAN1_DN2
R4	MDI_LAN1_DP1	R8	MDI_LAN1_DP3
R5	MDI_LAN1_DN1	R9	MDI_LAN1_DN3

A.7 Universal Serial Bus Port 3.1 Gen2 #3/ #4 (USB34)

A.8 RJ45 #2(LAN2)

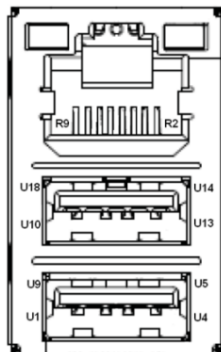

Pin	Signal	Pin	Signal
U1	+USBV2	U10	+USBV2
U2	USB_D3-	U11	USB_D4-
U3	USB_D3+	U12	USB_D4+
U4	GND	U13	GND
U5	USB31X3_z_RX- -	U14	USB31X4_z_RX-
U6	USB31X3_z_RX+	U15	USB31X4_z_RX+
U7	GND	U16	GND
U8	USB31X3_z_TX-	U17	USB31X4_z_TX-
U9	USB31X3_z_TX+	U18	USB31X4_z_TX+
Pin	Signal	Pin	Signal
R2	LAN2_MDI0+	R6	LAN2_MDI2+
R3	LAN2_MDI0-	R7	LAN2_MDI2-
R4	LAN2_MDI1+	R8	LAN2_MDI3+
R5	LAN2_MDI1-	R9	LAN2_MDI3-

A.9 Universal Serial Bus Port 3.1 Gen2 #6 (Type-C) (USB6)

Pin	Signal	Pin	Signal
A1	GND	B1	GND
A2	USB31X6_z_TX1+	B2	USB31X6_z_TX2+
A3	USB31X6_z_TX1-	B3	USB31X6_z_TX2-
A4	+USBV6	B4	+USBV6
A5	PI5USB31213_CC1	B5	PI5USB31213_CC2
A6	USB_D6+	B6	USB_D6+
A7	USB_D6-	B7	USB_D6-
A8	NC	B8	NC
A9	+USBV6	B9	+USBV6

A10	USB31X6_z_RX2-	B10	USB31X6_z_RX1-
A11	USB31X6_z_RX2+	B11	USB31X6_z_RX1+
A12	GND	B12	GND

A.10 Universal Serial Bus Port 3.1 Gen2 #5 (USB5)

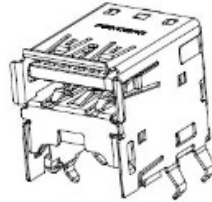

Pin	Signal	Pin	Signal
1	+USBV5	6	USB31X5_z_RX+
2	USB_D5-	7	GND
3	USB_D5+	8	USB31X5_z_TX-
4	GND	9	USB31X5_z_TX+
5	USB31X5_z_RX-		

A.11 HD Audio Interface (Analog) (AUDIO1)

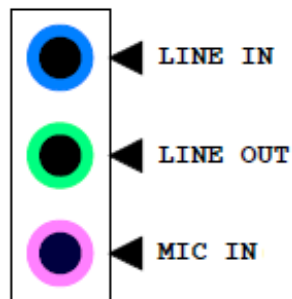

Pin	Signal
1	MIC IN
2	LINE OUT
3	LINE IN

A.12 Amplifier connector (AMP1)

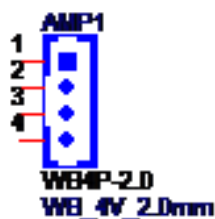

Pin	Signal
1	SPK_R+
2	SPK_R-
3	SPK_L-
4	SPK_L+

A.13 Front panel audio header (FPAUD1)

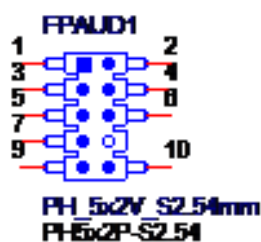

Pin	Signal	Pin	Signal
1	A_z_MIC2-L	2	GND
3	A_z_MIC2-R	4	AFP_PRESEN#
5	A_z_LINE2-R	6	A_MIC2-JD
7	SENSE	8	KEY
9	A_z_LINE2-L	10	A_LINE2-JD

A.14 CMOS Mode selection (JCMOS1)



Pin	Signal
1	N/A
2	RTC RESET#
3	GND

A.15 PCI Express x16 slot (PCIEX16_1)

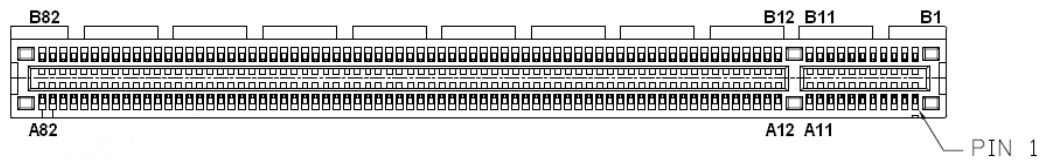

Pin	Signal	Pin	Signal
B1	+12V	A1	PRSNT1#
B2	+12V	A2	+12V
B3	+12V	A3	+12V
B4	GND	A4	GND
B5	SMB_CLK	A5	Reserved
B6	SMB_DATA	A6	Reserved
B7	GND	A7	Reserved
B8	+3.3V	A8	Reserved
B9	Reserved	A9	+3.3V
B10	+3.3VAUX	A10	+3.3V
B11	WAKE#	A11	PWRGD
B12	Reserved	A12	GND
B13	GND	A13	REFCLK+
B14	TX0+	A14	REFCLK-
B15	TX0-	A15	GND
B16	GND	A16	RX0+
B17	Reserved	A17	RX0-
B18	DETECT#	A18	GND
B19	TX1+	A19	CONFIG1
B20	TX1-	A20	GND
B21	GND	A21	RX1+
B22	GND	A22	RX1-
B23	TX2+	A23	GND
B24	TX2-	A24	GND
B25	GND	A25	RX2+
B26	GND	A26	RX2-
B27	TX3+	A27	GND
B28	TX3-	A28	GND
B29	GND	A29	RX3+
B30	Reserved	A30	RX3-

B31	Reserved	A31	GND
B32	GND	A32	CONFIG2
B33	TX4+	A33	Reserved
B34	TX4-	A34	GND
B35	GND	A35	RX4+
B36	GND	A36	RX4-
B37	TX5+	A37	GND
B38	TX5-	A38	GND
B39	GND	A39	RX5+
B40	GND	A40	RX5-
B41	TX6+	A41	GND
B42	TX6-	A42	GND
B43	GND	A43	RX6+
B44	GND	A44	RX6-
B45	TX7+	A45	GND
B46	TX7-	A46	GND
B47	GND	A47	RX7+
B48	Reserved	A48	RX7-
B49	GND	A49	GND
B50	TX8+	A50	Reserved
B51	TX8-	A51	GND
B52	GND	A52	RX8+
B53	GND	A53	RX8-
B54	TX9+	A54	GND
B55	TX9-	A55	GND
B56	GND	A56	RX9+
B57	GND	A57	RX9-
B58	TX10+	A58	GND
B59	TX10-	A59	GND
B60	GND	A60	RX10+
B61	GND	A61	RX10-
B62	TX11+	A62	GND
B63	TX11-	A63	GND
B64	GND	A64	RX11+
B65	GND	A65	RX11-
B66	TX12+	A66	GND
B67	TX12-	A67	GND
B68	GND	A68	RX12+

B69	GND	A69	RX12-
B70	TX13+	A70	GND
B71	TX13-	A71	GND
B72	GND	A72	RX13+
B73	GND	A73	RX13-
B74	TX14+	A74	GND
B75	TX14-	A75	GND
B76	GND	A76	RX14+
B77	GND	A77	RX14-
B78	TX15+	A78	GND
B79	TX15-	A79	GND
B80	GND	A80	RX15+
B81	Reserved	A81	RX15-
B82	Reserved	A82	GND

A.16 CMOS battery connector (BAT1)



Pin	Signal
1	+VBAT
2	GND

A.17 Case Open connector (JCASEOP_SW1)

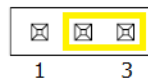

Pin	Signal
1	CASEOP#(Normal
2	HWM_CASEOP#
3	CASEOP (Normal

A.18 Case Open connector (JCASE1)



Pin	Signal
1	Case Open
2	GND

A.19 NGFF M.2 B-Key connector for 2242/3042 module (M2B1)

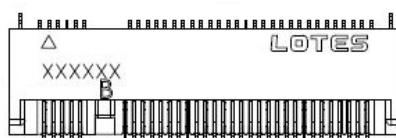

Pin	Signal	Pin	Signal
1	M.2_CONFIG_3	39	GND
2	+V3.3_M.2_B	40	M.2_ISH_SCL_R
3	GND	41	M.2_PCIE_RX11+
4	+V3.3_M.2_B	42	M.2_ISH_SDA_R
5	GND	43	M.2_PCIE_RX11-
6	M.2_POWER_OFF#_R	44	N/C
7	USB2_D11+	45	GND
8	M.2_W_DISABLE1#_R	46	N/C
9	USB2_D11-	47	M.2_PCIE_TX11-
10	LED3	48	N/C
11	GND	49	M.2_PCIE_TX11+
12	KEY	50	M.2_B_PLTRST#
13	KEY	51	GND
14	KEY	52	M.2_B_CKR_REQ#_R
15	KEY	53	CLK100M_M.2_B-
16	KEY	54	M.2_PCIE_WAKE#
17	KEY	55	CLK100M_M.2_B+
18	KEY	56	M.2_SMB_CLK_MAIN
19	KEY	57	GND
20	N/C	58	M.2_SMB_DATA_MAIN
21	M.2_CONFIG_0	59	N/C
22	N/C	60	N/C
23	M.2_PCIE_WAKE#	61	N/C
24	N/C	62	N/C
25	M.2_SAR_DPR	63	N/C
26	M.2_GNSS_DISABLE#_R	64	N/C

27	GND	65	N/C
28	N/C	66	N/C
29	M.2_PCIE_RX12-	67	M.2_RESET#_R
30	UIM-RESET	68	PCH_SUSCLK
31	M.2_PCIE_RX12+	69	M.2_CONFIG_1
32	UIM-CLK	70	+V3.3_M.2_B
33	GND	71	GND
34	UIM-DATA	72	+V3.3_M.2_B
35	M.2_PCIE_TX12-	73	GND
36	UIM-PWR	74	+V3.3_M.2_B
37	M.2_PCIE_TX12+	75	M.2_CONFIG_2
38	N/C		

A.20 Universal Serial Bus Port 3.1 Gen1 #9/ #10 box header (USB910)



BH_10x2V_2.00mm

Pin	Signal	Pin	Signal
1	+USB2V910	11	USB_D10+
2	USB3X9_z_RX-	12	USB_D10-
3	USB3X9_z_RX+	13	GND
4	GND	14	USB3X10_z_TX+
5	USB3X9_z_TX-	15	USB3X10_z_TX-
6	USB3X9_z_TX+	16	GND
7	GND	17	USB3X10_z_RX+
8	USB_D9-	18	USB3X10_z_RX-
9	USB_D9+	19	+USB2V910
10	NC		

A.21 COM1 RI# selection pin header (JSETCOM1_V1)

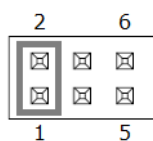

Pin	Signal	Pin	Signal
1	RI# [1]	2	Advantech define
3	Advantech define	4	+5V
5	+12V	6	Advantech define

A.22 Serial ATA interface connector #1~#3 (SATA1~SATA3)



Pin	Signal
1	GND
2	TX+
3	TX-
4	GND
5	RX-
6	RX+
7	GND

A.23 COM2 pin header (S1.27MM) (COM2)

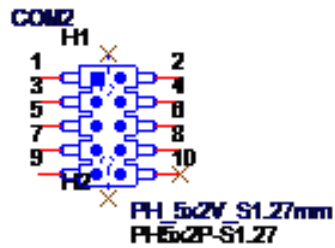

Pin	Signal	Pin	Signal
1	COM2_422_485_TX-	6	COM2_CTS#
2	COM2_DSR#	7	COM2_422_RX-
3	COM2_422_485_TX+	8	COM2_RI#
4	COM2_RTS#	9	GND
5	COM2_422_RX+	10	NC

A.24 EDP/LVDS Backlight inverter power connector (INV1)

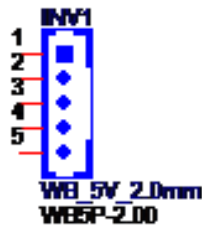

Pin	Signal
1	+V12_INV1
2	GND
3	INV1_ENBKL
4	INV1_VBR
5	+V5_INV1

A.25 COM1 pin header (S1.27MM) (COM1)

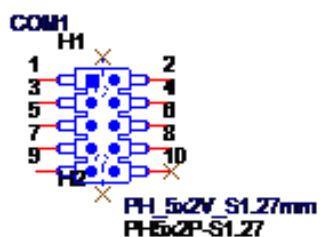

Pin	Signal	Pin	Signal
1	COM1_DCD#	6	COM1_CTS#
2	COM1_DSR#	7	COM1_DTR#
3	COM1_SIN	8	COM1_RI_V#
4	COM1_RTS#	9	GND
5	COM1_SOUT	10	NC

A.26 Low pin count interface connector (LPC1)

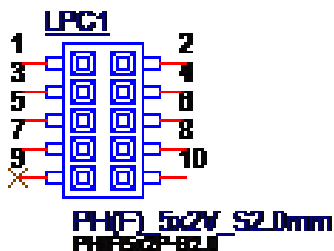

Pin	Signal	Pin	Signal
1	LPC_PCH_AD1	2	CLK24M_PCH_eSPI_LPC1
3	LPC_PCH_AD0	4	PLTRST_eSPI_LPC#
5	+V3.3	6	LPC_PCH_FRAME#
7	GND	8	LPC_PCH_AD3
11	NC	12	LPC_PCH_AD2

A.27 Subscriber Identity Module connector (SIM1)

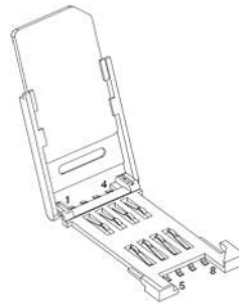

Pin	Signal
C1	UIM-PWR
C2	UIM-RESET
C3	UIM-CLK
C5	GND
C6	NC
C7	UIM-DATA

A.28 LVDS VESA, JEIDA format selection pin header (JLVDS_VCON1)

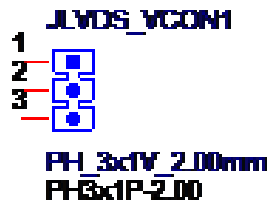

Pin	Signal	Pin	Signal
1	+V3.3	2	LVDS1_VCON
3	GND		

A.29 Low-voltage differential signaling interface/ Embedded displayport (LVDS_EDP1)

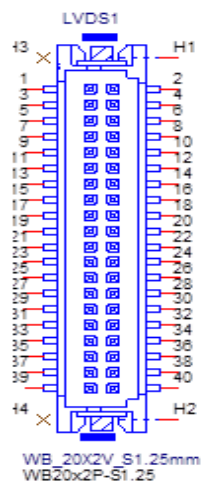

Pin	Signal	Pin	Signal
1	VDD	21	A2P
2	VDD	22	A6P
3	DET#	23	GND
4	GND	24	GND
5	VDD	25	CLK1N(EDP_CPU_TXN3)
6	VDD	26	CLK2N
7	A0N(EDP_CPU_TXN2)	27	CLK1P(EDP_CPU_TXP3)
8	A4N	28	CLK2P
9	A0P(EDP_CPU_TXP2)	29	GND
10	A4P	30	GND
11	GND	31	SCD
12	GND	32	SDD
13	A1N	33	GND
14	A5N	34	GND(EDP_CH7511_HPD)
15	A1P	35	A3N
16	A5P	36	A7N
17	GND	37	A3P
18	GND	38	A7P
19	A2N	39	ENBKL
20	A6N	40	VCON

A.30 Voltage selection for JLVDS connector (JLVDS1)

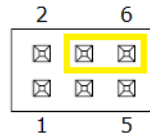

Pin	Signal	Pin	Signal
1	NC	2	+5V
3	+12V	4	VDD_LVDS1
5	NC	6	+3.3V

A.31 System Fan #1 connector /System Fan #2 connector (SYSFAN1/2)

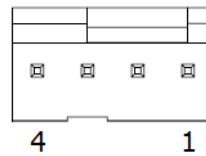

Pin	Signal(SYSFAN1)
1	GND
2	SYS1_FAN_OUT
3	SYSFAN1_SPEED
4	SYS1_FAN_PWMOUT_R
Pin	Signal(SYSFAN2)
1	GND
2	SYS2_FAN_OUT
3	SYS2_FAN_SPEED
4	SYS2_FAN_PWMOUT_R

A.32 Power LED and keyboard lock pin header (JFP2)

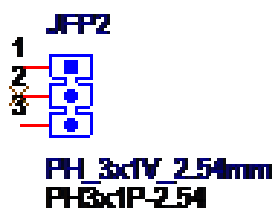

Pin	Signal
1	SIO_SUSLED_R
2	NC
3	SIO_SUSLED

A.33 Watchdog timer output and OBS beep (JWDT1+JOBS1)



Pin	Signal	Pin	Signal
1	NC	2	SIO_WG#
3	FP_SYS_RESET#	4	SIO_ERR_BEEP
5	SIO_OBS_BEEP		

A.34 CPU FAN connector (CPUFAN1)



Pin	Signal
1	GND
2	CPU FAN VCC
3	CPU FAN SPEED
4	CPU FAN PWM

A.35 8-bits General Purpose I/O pin header(S1.27MM) (GPIO1)

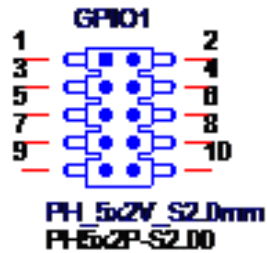

Pin	Signal	Pin	Signal
1	GPIO0	2	GPIO4
3	GPIO1	4	GPIO5
5	GPIO2	6	GPIO6
7	GPIO3	8	GPIO7
9	+V5_DUAL	10	GND

A.36 PWRBTN#/ RESET#/HDD LED/ Serial bus from HW monitor IC/Internal Buzzer / External Speaker header (JFP1)

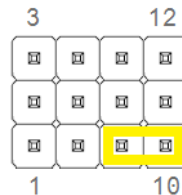

Pin	Signal	Pin	Signal
1	+5V	2	HDD LED+
3	Power Button+	4	SPK_P2
5	HDD LED-	6	Power Button-
7	SPK_P3	8	SMB_DATA
9	System Reset+	10	SPK_P4
11	SMB_CLK	12	System Reset-

A.37 SPI BIOS flash socket (SPI1)

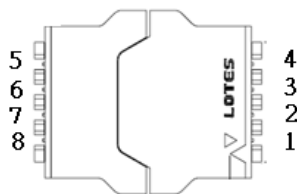

Pin	Signal	Pin	Signal
1	CS#	5	MOSI
2	MISO	6	SCLK
3	WP# / IO2	7	HOLD# / IO3
4	GND	8	+3.3V

A.38 Serial ATA interface power connector (SATA_PWR1/2)

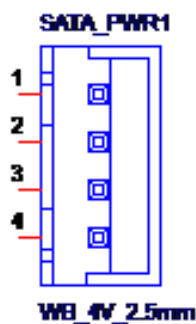

Pin	Signal
1	+5V
2	GND
3	GND
4	+12V

A.39 AT/ATX Mode selection (PSON1)

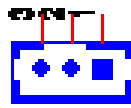

PSON2
WE_3V_2.0mm
WE3P-2.00

PSON1(2-3)1



MINIJUMPER_2_2.0mm
MINIJUMPER2P-2.00

Pin	Signal
1	VCCAT
2	+V3.3_DUAL
3	VCCATX

A.40 ATX supported 3-pin header on board (ATX_5VSB1)

ATX_5VSB1



WE_3V_2.0mm

Pin	Signal
1	+V5SB
2	GND
3	SPS_PS_ON#

A.41 NGFF M.2 E-Key connector for 2230 module (M2E1)

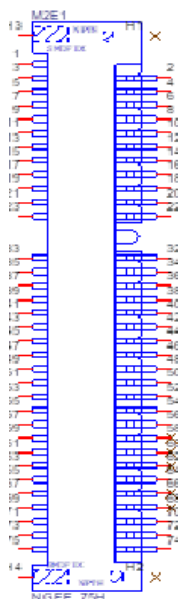

Pin	Signal	Pin	Signal
1	GND	39	GND
2	+V3.3_M.2_E	40	PCH_CLINK_DATA
3	USB2_D12+	41	M.2_PCIE_RX7+
4	+V3.3_M.2_E	42	PCH_CLINK_CLK
5	USB2_D12-	43	M.2_PCIE_RX7-
6	M.2_BT_LED1	44	CNV_GNSS_BLANKING_R
7	GND	45	GND
8	M.2_BT_PCMCLK	46	CNV_MFUART2_TXD_R
9	CNV_WR_z_D1-	47	CLK100M_M.2_E+
10	M.2_BT_PCMSYNC	48	CNV_MFUART2_RXD_R
11	CNV_WR_z_D1+	49	CLK100M_M.2_E-
12	M.2_BT_PCMIN	50	PCH_SUSCLK_R
13	GND	51	GND
14	M.2_BT_PCMOUT	52	M.2_E_PLTRST#
15	CNV_WR_z_D0-	53	M.2_E_CKR_REQ#_R
16	M.2_BT_LED2	54	M.2_BT_DISABLE#_R
17	CNV_WR_z_D0+	55	WLAN_PCIE_WAKE#
18	GND	56	M.2_WIFI_OFF#_R
19	GND	57	GND
20	UART_WAKE#	58	N/C
21	CNV_WR_z_CLK-	59	CNV_WT_z_D1-
22	CNV_BRI_RSP_R	60	N/C
23	CNV_WR_z_CLK+	61	CNV_WT_z_D1+
24	KEY	62	N/C
25	KEY	63	GND

26	KEY	64	M.2_38P4M_REFCLK_R
27	KEY	65	CNV_WT_z_D0-
28	KEY	66	N/C
29	KEY	67	CNV_WT_z_D0+
30	KEY	68	N/C
31	KEY	69	GND
32	CNV_RGI_DT_R	70	WIGI_PCIE_WAKE#
33	GND	71	CNV_WT_z_CLK-
34	CNV_RGI_RSP_R	72	+V3.3_M.2_E
35	M.2_PCIE_TX7+	73	CNV_WT_z_CLK+
36	CNV_BRI_DT_R	74	+V3.3_M.2_E
37	M.2_PCIE_TX7-	75	GND
38	PCH_CLINK_RST#		

ADVANTECH

Enabling an Intelligent Planet

www.advantech.com

Please verify specifications before quoting. This guide is intended for reference purposes only.

All product specifications are subject to change without notice.

No part of this publication may be reproduced in any form or by any means, electronic, photocopying, recording or otherwise, without prior written permission of the publisher.

All brand and product names are trademarks or registered trademarks of their respective companies.

© Advantech Co., Ltd. 2019