

EMMA-360

~170° side emitter

TECHNICAL SPECIFICATIONS:

Dimensions	9.9 x 9.9 mm
Height	5.7 mm
Fastening	glue, pin
ROHS compliant	yes ⓘ

MATERIAL SPECIFICATIONS:

Component	Type	Material	Colour	Finish
EMMA-360	Single lens	PMMA	clear	

ORDERING INFORMATION:

Component	Qty in box	MOQ	MPQ	Box weight (kg)
C13055_EMMA-360 » Box size:	5000	300	100	1.6



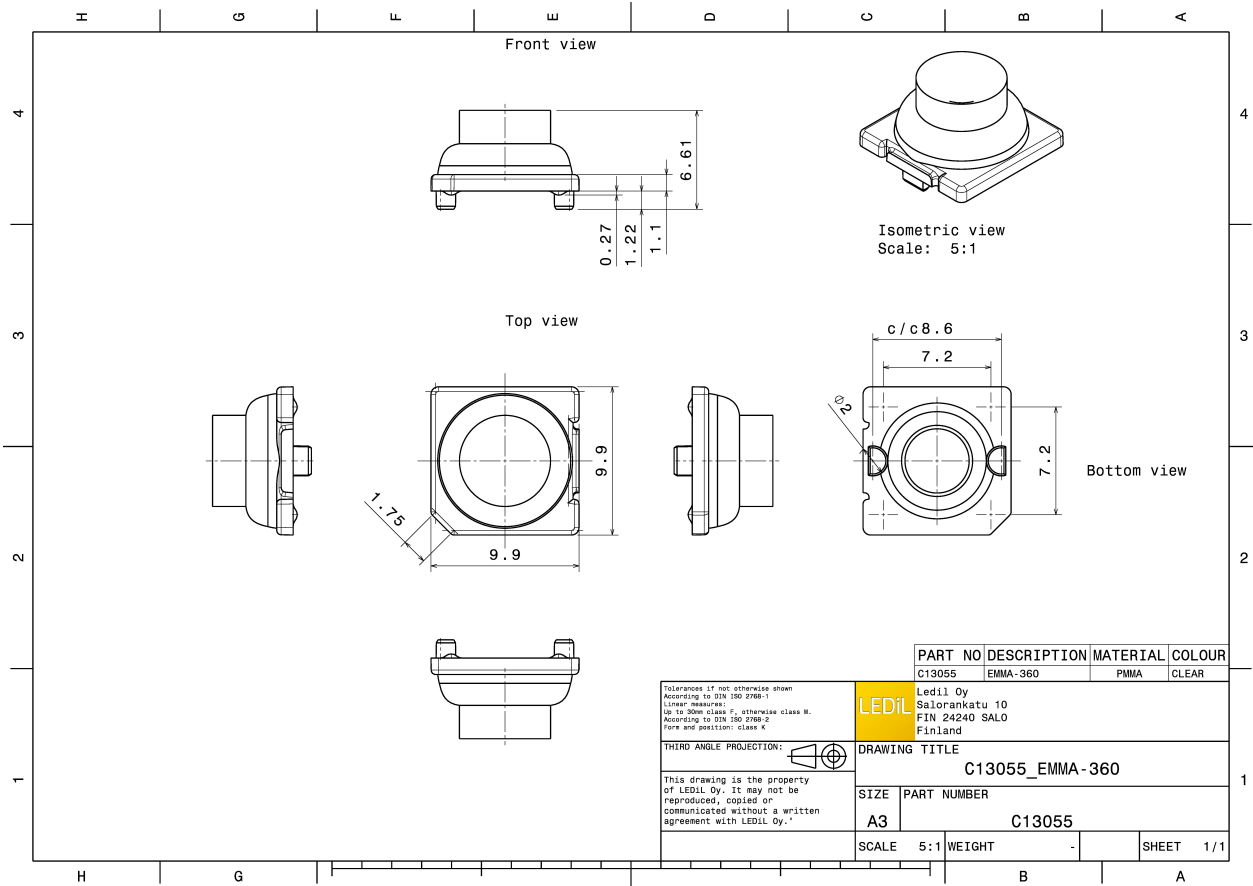

See also our general installation guide: www.ledil.com/installation_guide

PHOTOMETRIC DATA (MEASURED):

CREE

LED XB-D
 FWHM / FWTM 170.0°
 Efficiency 93 %
 Peak intensity 0.4 cd/lm
 LEDs/each optic 1
 Light colour White
 Required components:

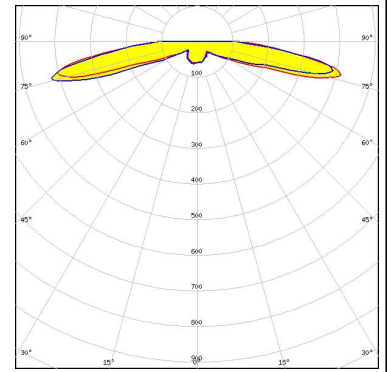

CREE

LED XP-E2
 FWHM / FWTM 172.0°
 Efficiency 94 %
 Peak intensity 0.4 cd/lm
 LEDs/each optic 1
 Light colour White
 Required components:

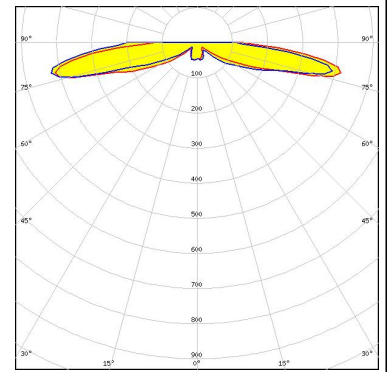

CREE

LED XP-G
 FWHM / FWTM 173.0°
 Efficiency 88 %
 Peak intensity 0.4 cd/lm
 LEDs/each optic 1
 Light colour White
 Required components:

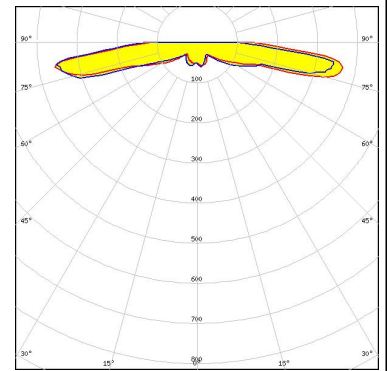

CREE

LED XP-G2
 FWHM / FWTM 172.0°
 Efficiency 90 %
 Peak intensity 0.4 cd/lm
 LEDs/each optic 1
 Light colour White
 Required components:

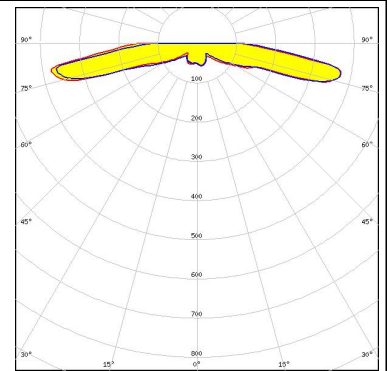

PHOTOMETRIC DATA (MEASURED):

CREE

LED XT-E
FWHM / FWTM 174.0° / 188.0°
Efficiency 94 %
Peak intensity 0.4 cd/lm
LEDs/each optic 1
Light colour White
Required components:

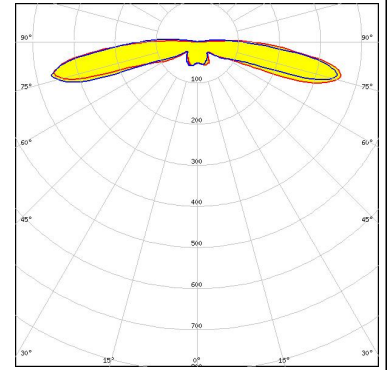

LUMILEDS

LED LUXEON 3535 2D
FWHM / FWTM 170.0°
Efficiency 94 %
Peak intensity 0.4 cd/lm
LEDs/each optic 1
Light colour White
Required components:

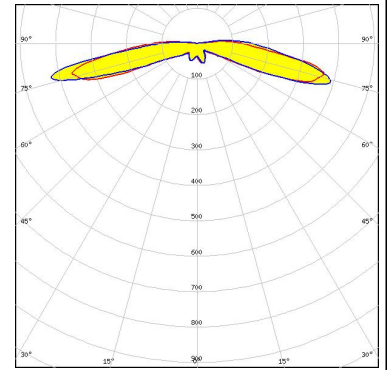

LUMILEDS

LED LUXEON A
FWHM / FWTM 173.0°
Efficiency 92 %
Peak intensity 0.4 cd/lm
LEDs/each optic 1
Light colour White
Required components:

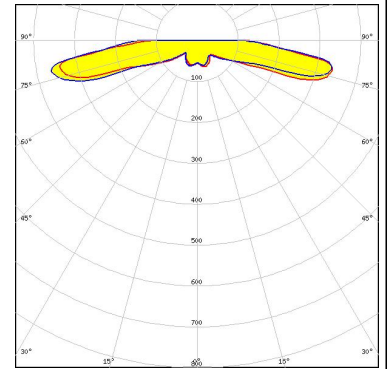

LUMILEDS

LED LUXEON Rebel
FWHM / FWTM 165.0°
Efficiency 93 %
Peak intensity 0.5 cd/lm
LEDs/each optic 1
Light colour White
Required components:

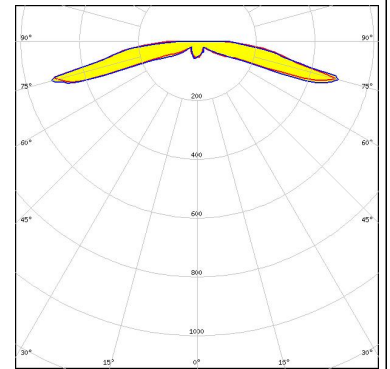

PHOTOMETRIC DATA (MEASURED):



LED NCSxx19A
FWHM / FWTM 165.0°
Efficiency 90 %
Peak intensity 0.4 cd/lm
LEDs/each optic 1
Light colour White
Required components:

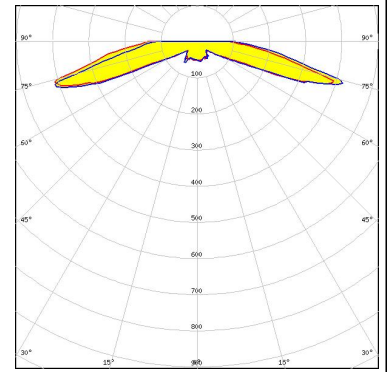

LED OSLON Square EC
FWHM / FWTM 170.0°
Efficiency 92 %
Peak intensity 0.4 cd/lm
LEDs/each optic 1
Light colour White
Required components:

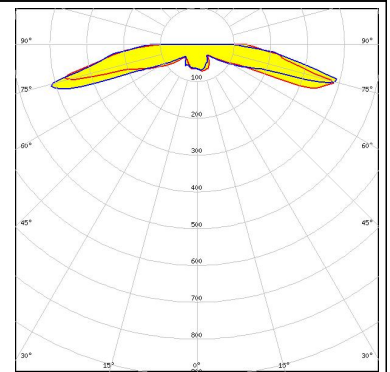

PHOTOMETRIC DATA (SIMULATED):



LED J Series 2835
 FWHM / FWTM 167.0° / 194.0°
 Efficiency 96 %
 Peak intensity 0.4 cd/lm
 LEDs/each optic 1
 Light colour White
 Required components:

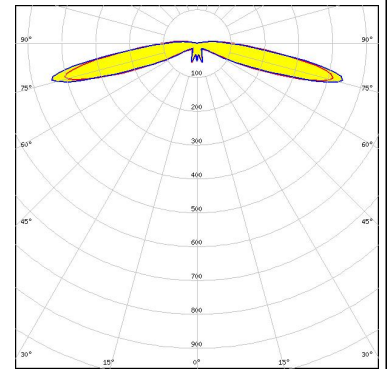

LED J Series 3030
 FWHM / FWTM 167.0° / 198.0°
 Efficiency 96 %
 Peak intensity 0.4 cd/lm
 LEDs/each optic 1
 Light colour White
 Required components:

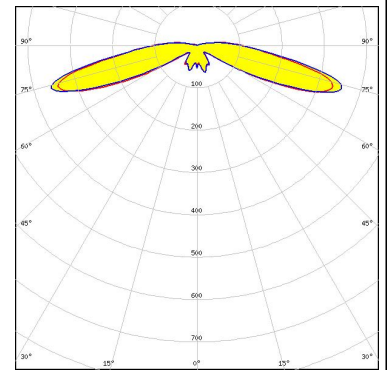

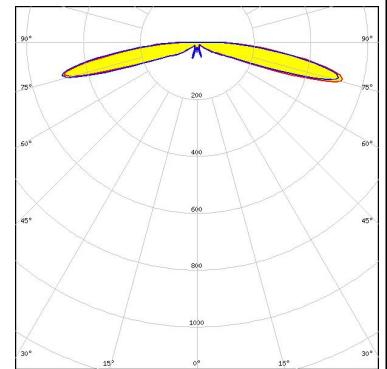

LED XQ-E HD
 FWHM / FWTM 164.0° / 174.0°
 Efficiency 92 %
 Peak intensity 0.5 cd/lm
 LEDs/each optic 1
 Light colour White
 Required components:

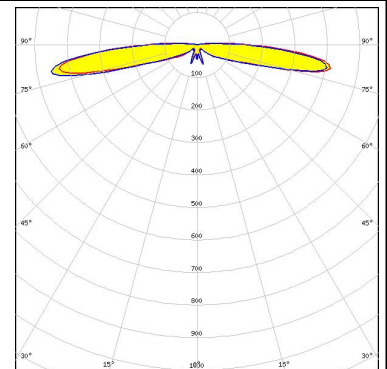

LED LUXEON C
 FWHM / FWTM 174.0° / 189.0°
 Efficiency 94 %
 Peak intensity 0.5 cd/lm
 LEDs/each optic 1
 Light colour Red
 Required components:

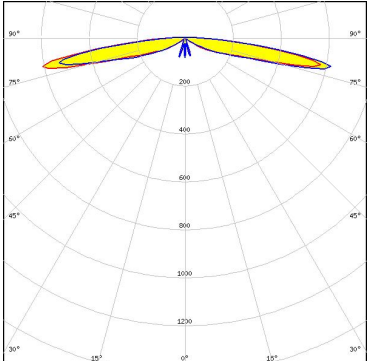
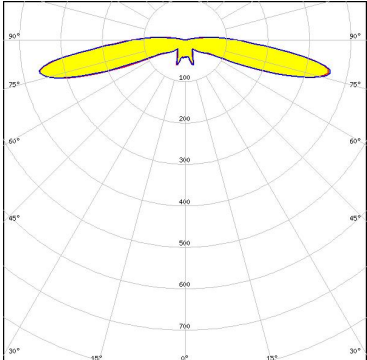
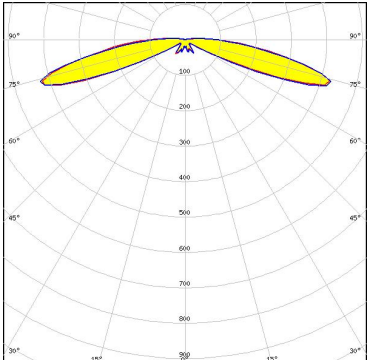

PHOTOMETRIC DATA (SIMULATED):

<p>LUMILEDS</p> <p>LED: LUXEON CZ FWHM / FWTM: 167.0° / 179.0° Efficiency: 94 % Peak intensity: 0.6 cd/lm LEDs/each optic: 1 Light colour: Red Required components:</p>	
<p>LUMILEDS</p> <p>LED: LUXEON V2 FWHM / FWTM: 172.0° / 196.0° Efficiency: 94 % Peak intensity: 0.4 cd/lm LEDs/each optic: 1 Light colour: White Required components:</p>	
<p>NICHIA</p> <p>LED: NCSxE17A FWHM / FWTM: 166.0° / 189.0° Efficiency: 94 % Peak intensity: 0.4 cd/lm LEDs/each optic: 1 Light colour: Green Required components:</p>	
<p>NICHIA</p> <p>LED: NF2W757G-MT (Tunable White) FWHM / FWTM: 174.0 + 178.0° / 182.0° Efficiency: 90 % Peak intensity: 0.4 cd/lm LEDs/each optic: 1 Light colour: Tunable White Required components:</p>	

PHOTOMETRIC DATA (SIMULATED):

SAMSUNG

LED LM28xB Series
 FWHM / FWTM 169.0° / 199.0°
 Efficiency 97 %
 Peak intensity 0.4 cd/lm
 LEDs/each optic 1
 Light colour White
 Required components:

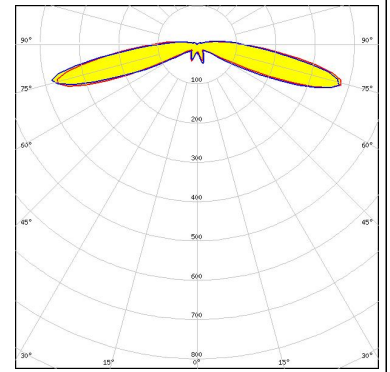

SEOUL SEMICONDUCTOR

LED MJT 3030
 FWHM / FWTM 172.0° / 194.0°
 Efficiency 95 %
 Peak intensity 0.5 cd/lm
 LEDs/each optic 1
 Light colour White
 Required components:

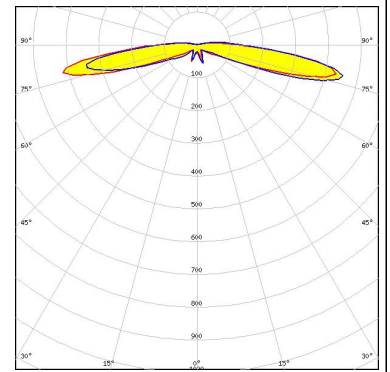

SEOUL SEMICONDUCTOR

LED Z8Y22P
 FWHM / FWTM 152.0°
 Efficiency 87 %
 Peak intensity 0.4 cd/lm
 LEDs/each optic 1
 Light colour White
 Required components:

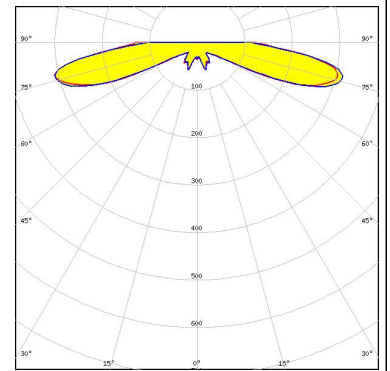

GENERAL INFORMATION:

NOTE: The typical beam angle will be changed by different color, chip size and chip position tolerance. The typical total beam angle is the full angle measured where the luminous intensity is half of the peak value.

MATERIALS:

As part of our continuous research and improvement processes, and to ensure the best possible quality and availability of our products, LEDiL reserves the right to change material grades without notice.

PRODUCT DATA USER AGREEMENT AND DISCLAIMER:

The measured data in the provided downloadable LEDiL Product Datasheets and Mechanical 2D-Drawings is rounded and provided as reference for planning. LEDiL Oy's optical specifications have been verified by conducting performance testing of the products in accordance with the company's quality system. The reported data are averaged results of multiple measurements with typical variation. LEDiL Oy reserves the right to without prior notification make changes and improvements to its products.

LEDiL Oy assumes neither warranty, nor guarantee nor any other liability of any kind for the contents and correctness of the provided data. The provided data has been generated with highest diligence but the provided data may in reality not represent the complete possible variation range of all intrinsic parameters. Therefore, in certain cases a deviation from the provided data could occur.

LEDiL Oy reserves the right to undertake technical changes of its products without further notification which could lead to changes in the provided data. LEDiL Oy assumes no liability of any kind for the possible deviation from any provided data or any other damage resulting from the usage of the provided data.

The user agrees to this disclaimer and user agreement with the download or usage of the provided files.

LEDiL Oy

Joensuunkatu 13
FI-24240 SALO
Finland

LEDiL Inc.

228 West Page Street
Suite D
Sycamore IL 60178
USA

Ledil Optics Technology (Shenzhen) Co., Ltd.

405 , Block B
Casic Motor Building
Shenzhen 518057
P.R.CHINA

Local sales and technical support

[www.ledil.com/
where_to_buy](http://www.ledil.com/where_to_buy)

Shipping locations

Salo, Finland
Hong Kong, China

Distribution Partners

[www.ledil.com/
where_to_buy](http://www.ledil.com/where_to_buy)