



SPECIFICATION SHEET

Customer:

Product: 1000222

Model: 2.4 x 348 | 0.269/0.271

Specifications

1. Available Range. The specifications available to CCFL unit listed on page 1.
2. Product Construction.

Item No.	Name	Requirements	Remark
1	Dimension	Lamp Shape: Straight	Naked lamp
		Dia: $\Phi 2.4 \pm 0.05\text{mm}$	
		Glass tube length: $348 \pm 1.0\text{mm}$	
2	Glass tube	Hard material glass tube	
3	Fluorescent powder	Three primary colors phosphor	
4	Electrode	Kovar	
5	Gas	70 Torr	Ne+Ar(95:5)

3. Primary Characteristics.
 - 3.1. Requests of Specifications

Item No.	Name	Code	Unit	Specification	Remark
1	Lamp Voltage (Reference)	VL	Vrms	$620 \pm 10\%$	KD12300 inverter 12V
2	Lamp Current	IL	MArms	$6.0 \pm 0.2\text{mA}$	
3	Starting Voltage (Reference)	Vs	Vrms	$950 \pm 10\%$	KD12300 6mA 25°C
4	Surface Brightness	B	Cd/m^2	$23000 \pm 10\%$	KD12300 6mA 25°C
5	Color Coordinates	x		0.269 ± 0.010	CIE 1931
		y		0.271 ± 0.010	
6	Peak Spectrum (Reference)		Nm	Red	611
				Green	544
				Blue	440
7	Stable Time of Illumination	Ts	min	3min	

3.2. Test Conditions

- 3.2.1. Lamp should be placed in horizontal position, under required testing current, and undergo normal lighting for more than 3 minutes, then conduct the electrical and optical properties tests
- 3.2.2. Temperature of Test Environment = $25^{\circ}\text{C}\pm 2^{\circ}\text{C}$
- 3.2.3. Relative Humidity of Test Environment = $65\%\pm 20\%$, under no wind state.

3.3. Test Apparatus

Test Items	Test Apparatus
Lamp Voltage	Oscilloscope (Tektronix TDS1012B 100:1)
Lamp Current	Multimeter (Fluke 8086 A)
Surface Brightness	Colorimeter (Topcon BM-7)
Color and Color Temp Coordinates	Colorimeter (Topcon BM-7)

3.4. Test Methods

- 3.4.1. CCFL unit under complete voltage control; the test circuit as shown in the Diagram below.
 - 3.4.1.1. LV output end connected to negative of 0V ~ 12V input
 - 3.4.1.2. The connection wire length is 100~300mm
 - 3.4.1.3. Test circuit wires parallel distance should be longer than 100mm in order to avoid possible interference which could affect measurement accuracy
 - 3.4.1.4. When testing current disconnect VL test equipment
 - 3.4.1.5. When testing voltage disconnect IL test equipment
 - 3.4.1.6. During testing, place CCFL unit on shelf with black background in a non-reflective environment

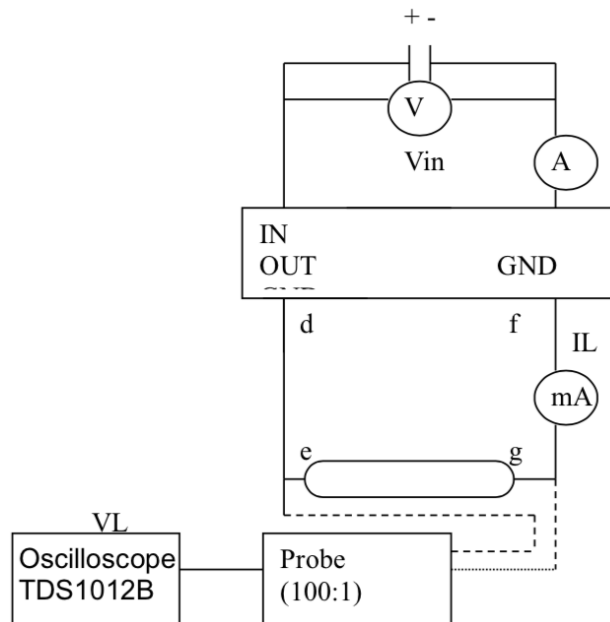

- 3.4.2. Brightness Measurement (naked lamp only), the Colorimeter should be kept a distance of 500 +/- 10mm from the lamp vertical axis and test black perspective at 0.1 degrees.
- 3.4.3. NOTE: testing done with difference test equipment and under different test conditions may result in measurement differences.

