

# STK600-RC064SAM-72

## Routing card for STK600

J3 and J4 mates with the socket card, while J1 and J2 goes down to the mother board. J1 is physical placed below J3, and J2 below J4.

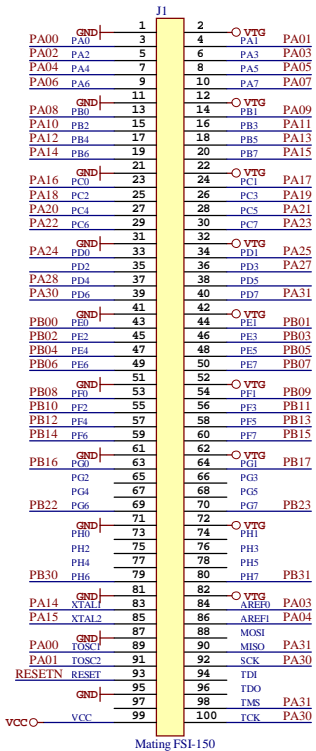

Mating FSI-150

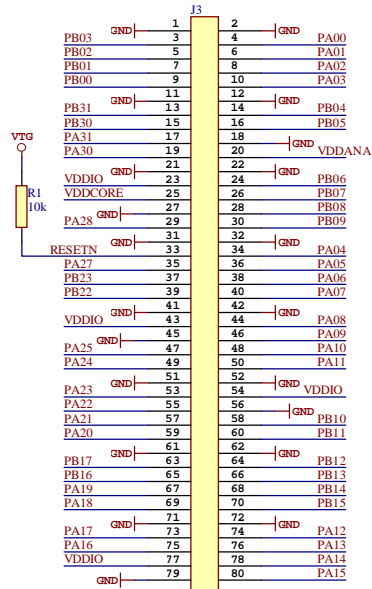

Mating FSI-140

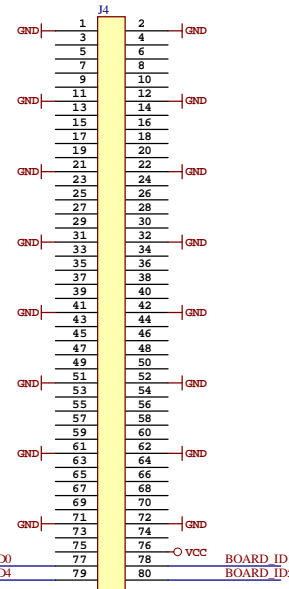

Mating FSI-140

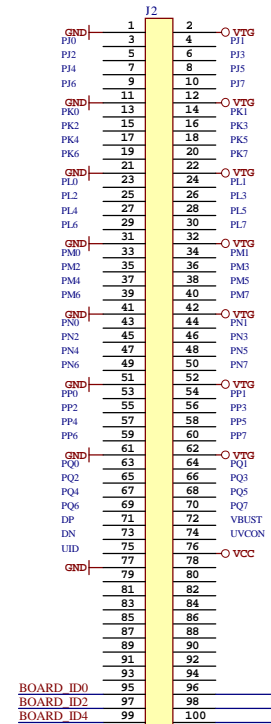

Mating FSI-150

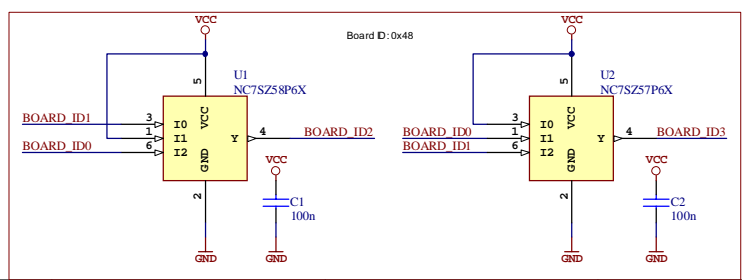
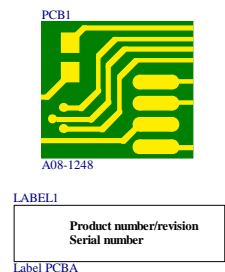
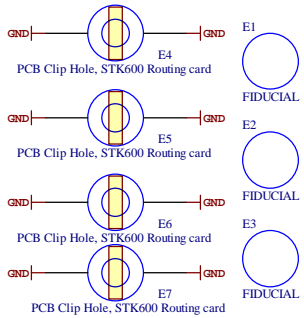
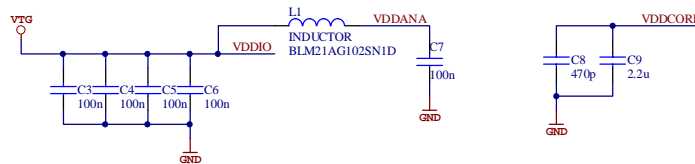

ATMEL Norway	*		
Vestre Rosten 79	*		
N-7075 TILLER	*		
NORWAY			
Date:	29.05.2013	14:18:16	PAGE: 1 of 1
Document number:	*		Revision: 3
TITLE: STK600-RC064SAM-72			
STK600-RC064SAM-72_SchDoc			

