

# CTL1206FYW1T DATASHEET

Chip Type LED, 1206, Flat Lens, Yellow



VENKEL LTD.

Part Number	Size	Emitting Color	Emitting Material	Lens-Color	Luminous Intensity ( $I_F=20\text{mA}$ ) mcd	Wavelength nm $\lambda_P$	Viewing Angle ( $2\theta$ 1/2)
CTL1206FYW1T	1206	Yellow	AlGaInP	Water Clear	80 min 125 typ	598	140°

Electrical & Optical Specifications ( $T_A=25^\circ\text{C}$ )		YW1 (AlGaInP)	Unit
Forward Voltage (Min.) ( $I_F=20\text{mA}$ )	$V_F$	1.7	V
Forward Voltage (Max.) ( $I_F=20\text{mA}$ )	$V_F$	2.6	V
Reverse Current (Max) ( $V_R=5\text{V}$ )	$I_R$	10	$\mu\text{A}$
Peak Wavelength (Typ.) ( $I_F=20\text{mA}$ )	$\lambda_P$	598	nm
Dominant Wavelength (Typ.) ( $I_F=20\text{mA}$ )	$\lambda_D$	595	nm
Spectral Line Half Width (Typ.) ( $I_F=20\text{mA}$ )	$\Delta\lambda$	15	nm

Absolute Maximum Ratings ( $T_A=25^\circ\text{C}$ )		YW1 (AlGaInP)	Unit
Reverse Voltage	$V_R$	5	V
DC Forward Current	$I_F$	25	mA
Peak Forward Current 1/10 Duty Cycle @ 10KHz	$I_{FP}$	60	mA
Power Dissipation	$P_D$	65	mW
Operating Temperature	$T_A$	-40 ~ +85	°C
Storage Temperature	$T_{stg}$	-40 ~ +100	

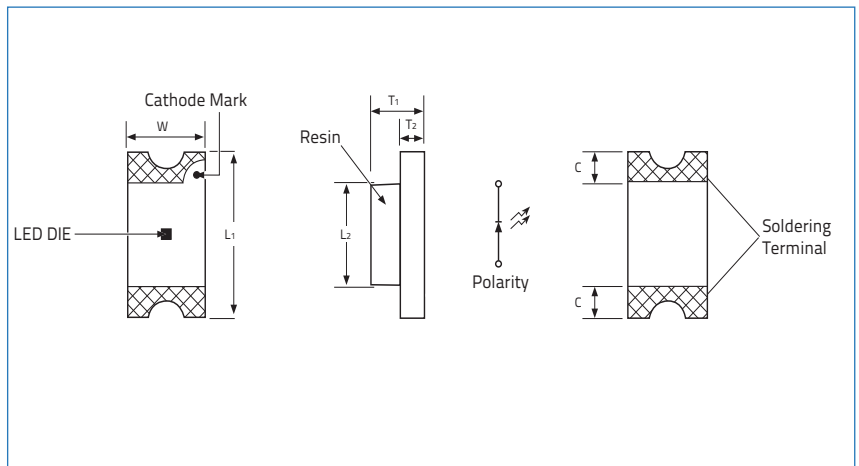

Dimensions				Units: Inches (mm)			
$L_1$	$L_2$	$T_1$	$T_2$	$W$	$C$		
0.126±0.004 (3.2±0.1)	0.079±0.004 (2.0±0.1)	0.0433±0.004 (1.1±0.1)	0.0197±0.004 (0.5±0.1)	0.063±0.004 (1.6±0.1)	0.0236±0.004 (0.6±0.1)		

## Soldering Pad Layout

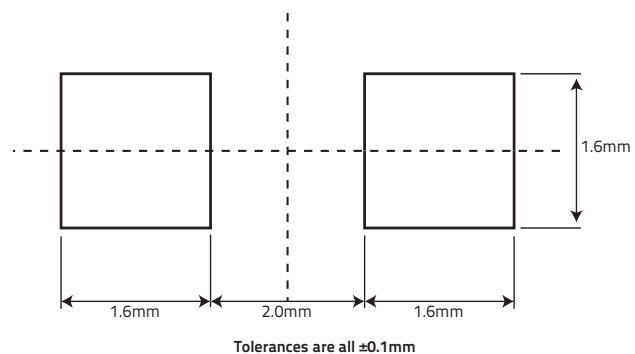

# CTL1206FYW1T DATASHEET

Chip Type LED, 1206, Flat Lens, Yellow



VENKEL LTD.

## Graphs

**Fig.1 Forward Current vs Forward Voltage**

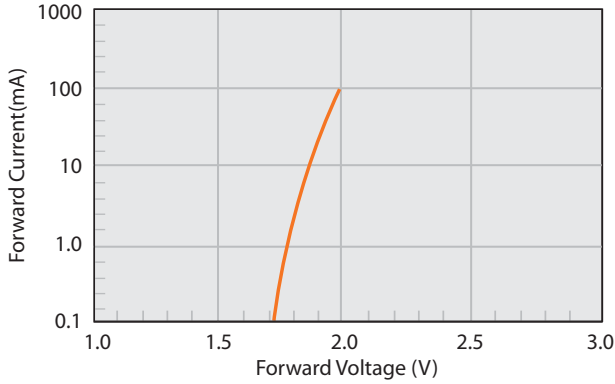

**Fig.4 Relative Intensity vs Temperature**

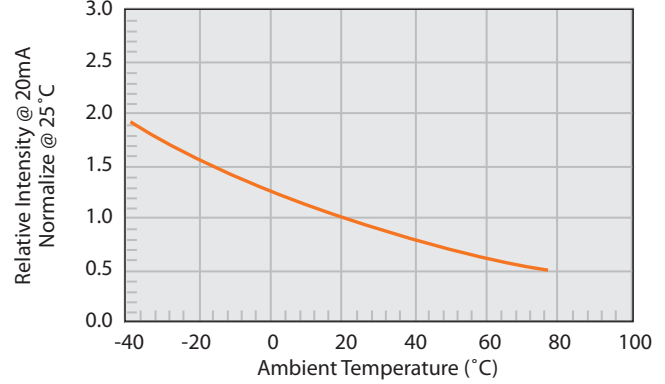

**Fig.2 Relative Intensity vs Forward Current**

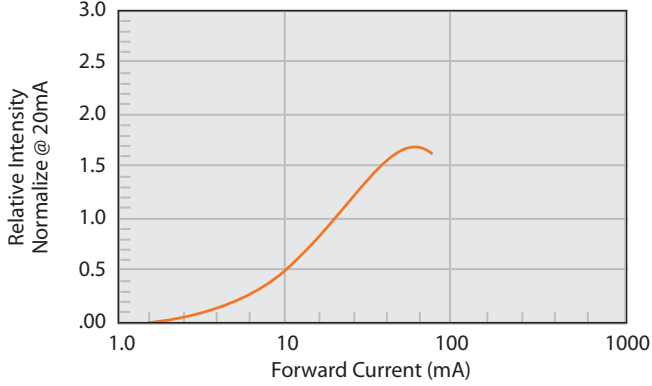

**Fig.5 Relative Intensity vs Wavelength**

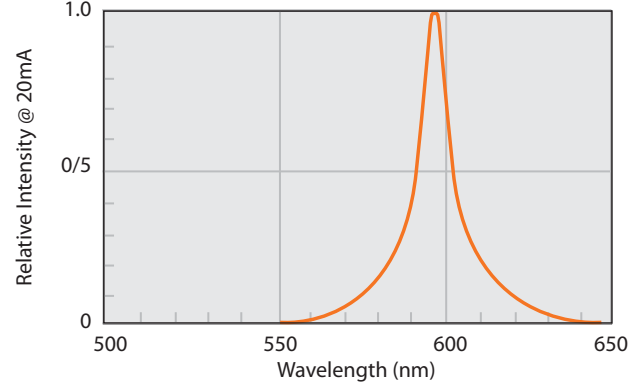

**Fig.3 Current vs Temp**

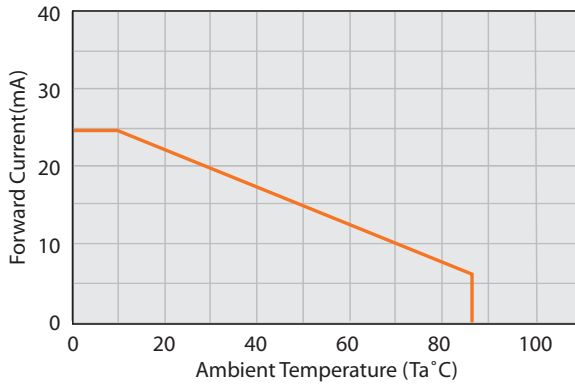

**Fig. 6 Direct Radiation**

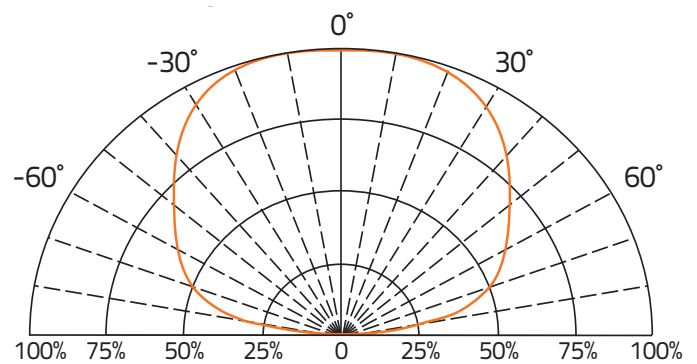

### Environmental information

RoHS Status	6 of 6 Compliant
REACH Status	Compliant
Halogen Status	Halogen Free
Conflict Mineral Status	Conflict Mineral Free
Moisture Sensitivity Level (MSL)	3

### Reflow profile

Max Reflow Temperature	260°C
Number of Reflow Cycles	2

# CTL1206FYW1T DATASHEET

Chip Type LED, 1206, Flat Lens, Yellow



VENKEL LTD.

## Label Example

Item: CTL1206FYW1T

Chip Type LED,1206,Flat Lens,Yellow

Qty: 3000

D/C: 1616

Lot: 20160502001

BIN/HUE: Q/18

VF: 2.0-2.2

**VENKEL LTD**

**YOUR SINGLE SOURCE FOR SURFACE MOUNT PASSIVES**

## Codes:

VF: Forward Voltage | BIN: Luminous Intensity | HUE: Dominant Wavelength

## Luminous Intensity Classification (BIN Code)

BIN Code	Iv(mcd) at 20mA	
	Min.	Max.
Q	80	125
R	125	200
S	200	320
T	320	500

## Dominant Wavelength Classification (HUE Code)

HUE Code	$\lambda_D$ (nm) at 20mA	
	Min.	Max.
17	589	592
18	592	595
19	595	598
20	598	600

# CTL1206FYW1T DATASHEET

Chip Type LED, 1206, Flat Lens, Yellow



VENKEL LTD.

Reel Specifications		Units: mm		
<b>M</b>	<b>C</b>	<b>F</b>	<b>E</b>	<b>G</b>
178±1.50	56.0±1.0	12.0±1.0	60.0±1.0	9.0±1.0

Packaging Specifications	
Reel Size:	7"
Quantity per Reel :	3,000

Storage Specifications
1. Storage temperature and RH: 5°C~35°C, RH60%
2. Once the package is opened, the LEDs should be used within a week. Otherwise, they should be kept in a moisture proof bag with desiccant. We suggest that you use this product within one year from date code.
3. If opened for more than one week in an atmosphere of 5°C~35°C, RH60%. The parts should be heat treated at 60°C±5°C for 15 hours.

Tape Specifications		Units: mm		
<b>T</b>	<b>W</b>	<b>A</b>	<b>B</b>	<b>F</b>
1.36±0.5	8.0±0.3	3.38±0.5	1.76±0.1	3.5±0.2
<b>E</b>	<b>H</b>	<b>J</b>	<b>D</b>	<b>G</b>
1.75±0.1	4.0±0.2	2.0±0.1	1.5±0.1	4.0±0.2

# CTL1206FYW1T DATASHEET

Chip Type LED, 1206, Flat Lens, Yellow



VENKEL LTD.

Environmental Test Criteria			
Classification	Test Item	Test Condition	Sample Size
Endurance Test	Operating Life	1. Ta=25°C 2. If=20mA 3. t=1000hrs (-24hrs, +72hrs)	22
	High Temperature Storage	1. Ta=105°C±5°C 2. t=1000hrs (-24hrs, +72hrs)	22
	Low Temperature Storage	1. Ta=-40°C±5°C 2. t=1000hrs (-24hrs, +72hrs)	22
	High Temperature, High Humidity Storage	1. Ta=85°C 2. RH=85% 3. t=1000hrs(-24hrs, +72hrs)	22
Environmental Test	Thermal Shock	1. Ta=100°C±5°C & -40°C±5°C 20min / 10sec / 20min 3. Total: 100 cycles total	22
	Temperature Cycling	1. 100°C±5°C & -40°C±5°C 30mins / 5mins / 30mins 2. 100 Cycles	22
	IR Reflow	1. T=260°C Max. 10 seconds Max 2. 6 Min	22

## Drive Method

LED is a current operated drive, and therefore it requires some kind of current limiting incorporated into the driver circuit. This current limiting typically takes the form of a current limiting resistor placed in series with the LED. Consider worst case voltage variations that can occur across the current limiting resistor placed in series with the LED. The forward current should not be allowed to change by more than 40% of its desired value.

