

SERIES: VOF-200C | **DESCRIPTION:** AC-DC POWER SUPPLY**FEATURES**

- universal input voltage (85 ~ 264 Vac)
- active power factor correction
- certified to 62368, 60335, and 61558 safety standards
- suitable for safety class I or class II installations
- over voltage, over current, over temperature, and short circuit protections
- adjustable output via trim POT
- low leakage current (< 0.1 mA)
- low standby power consumption (0.5 W)

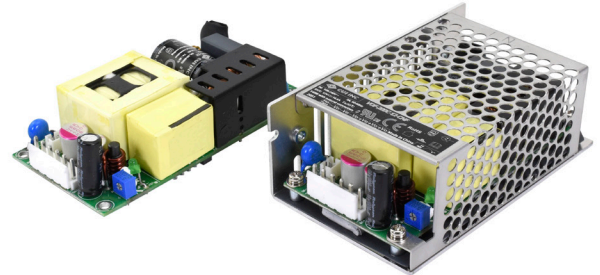

MODEL	output voltage		output current	output power	ripple and noise ²	efficiency ³
	(Vdc)	range ¹ (Vdc)	max (A)	max (W)	max (mVp-p)	typ (%)
VOF-200C-12	12	11.8~12.6	16.6	200	60	93
VOF-200C-15	15	14.7~15.8	13.3	200	100	93
VOF-200C-24	24	23.5~25.2	8.33	200	100	94
VOF-200C-27	27	26.5~28.4	7.40	200	100	94
VOF-200C-36	36	35.28~37.8	5.56	200	100	94
VOF-200C-48	48	47.1~50.4	4.16	200	100	94

Notes:

1. When adjusting the output voltage care should be taken never to exceed the stated output power or output current of the unit.
2. At full load, nominal input, 20 MHz bandwidth oscilloscope, tip & barrel method, output terminated with 10 μ F electrolytic and 0.1 μ F ceramic capacitors. Under light load conditions (<15%) the measurement may double in an effort to maximize converter efficiency.
3. At 230 Vac.

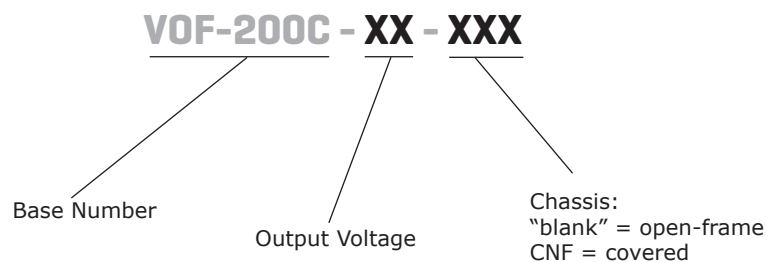
PART NUMBER KEY

INPUT

parameter	conditions/description	min	typ	max	units
voltage	ac input	85		264	Vac
	dc input	120		370	Vdc
frequency		47		63	Hz
current	at 115 Vac			3.0	A
	at 230 Vac			2.0	A
inrush current	at 115 Vac, cold start		40		A
	at 230 Vac, cold start		75		A
leakage current	at 240 Vac			0.1	mA
power factor correction	at 115 Vac, full load	0.99			
	at 230 Vac, full load	0.95			
no load power consumption			0.5		W

OUTPUT

parameter	conditions/description	min	typ	max	units
output capacitance	12 Vdc output model			6,000	μF
	15 Vdc output model			5,000	μF
	24 Vdc output model			3,200	μF
	27 Vdc output model			2,400	μF
	36 Vdc output model			2,000	μF
	48 Vdc output model			1,600	μF
initial set point accuracy	full load		±1		%
line regulation	rated load		±0.5		%
load regulation	0 ~ 100% load		±0.5		%
hold-up time	at 230 Vac, 25°C		12		ms
temperature coefficient			±0.03		%/°C
fan power ¹	15 Vdc output models, 6W max	20.4	24	27.6	V
	other output models, 6W max	10.2	12	13.8	V

Note: 1. With output voltage accuracy ±15%.

PROTECTIONS

parameter	conditions/description	min	typ	max	units
over voltage protection	output shutdown, latching				
	12 Vdc output model		16		Vdc
	15 Vdc output model		20		Vdc
	24 Vdc output model		32		Vdc
	27 Vdc output model		35		Vdc
	36 Vdc output model		50		Vdc
48 Vdc output model		60		Vdc	
over current protection	hiccup, auto recovery	110			%
short circuit protection	continuous, auto recovery, hiccup				
over temperature protection	output shutdown, auto recovery				

SAFETY & COMPLIANCE

parameter	conditions/description	min	typ	max	units
isolation voltage	input to ground for 1 minute, <10 mA	1,500			Vac
	input to output for 1 minute, <10 mA	4,000			Vac
	output to ground for 1 minute, <10 mA	1,500			Vac
safety approvals	certified to 62368: UL, EN certified to 60335: EN certified to 61558: EN				
safety class	class I (with PE), class II (without PE)				
conducted emissions ¹	CISPR32/EN55032 CLASS B				
radiated emissions ¹	CISPR32/EN55032 (Class B for safety class I installations; Class A for safety class II installations)				
harmonic current	IEC/EN61000-3-2 CLASS D				
ESD	IEC/EN61000-4-2 Contact ±8KV/Air ±15KV perf. Criteria A				
radiated immunity	IEC/EN61000-4-3 10V/m perf. Criteria A				
EFT/burst	IEC/EN61000-4-4 ±4KV perf. Criteria A				
surge	IEC/EN61000-4-5 ±2KV/±4KV perf. Criteria A				
conducted immunity	IEC/EN61000-4-6 10 Vr.m.s perf. Criteria A				
voltage dips and interruptions	IEC/EN61000-4-11 0%, 70% perf. Criteria B				
MTBF	as per MIL-HDBK-217F, at 25°C	300,000			hours
RoHS	yes				

Notes: 1. The power supply is considered a component of the end system. All EMC performance has been tested on a metal plate with the dimensions 360 x 360 x 1 mm. The power supply must be integrated into the end system for proper electromagnetic compatibility testing.

ENVIRONMENTAL

parameter	conditions/description	min	typ	max	units
operating temperature	see derating curves	-40		70	°C
storage temperature		-40		85	°C
operating humidity	non-condensing	20		90	%
storage humidity	non-condensing	10		95	%

DERATING CURVES

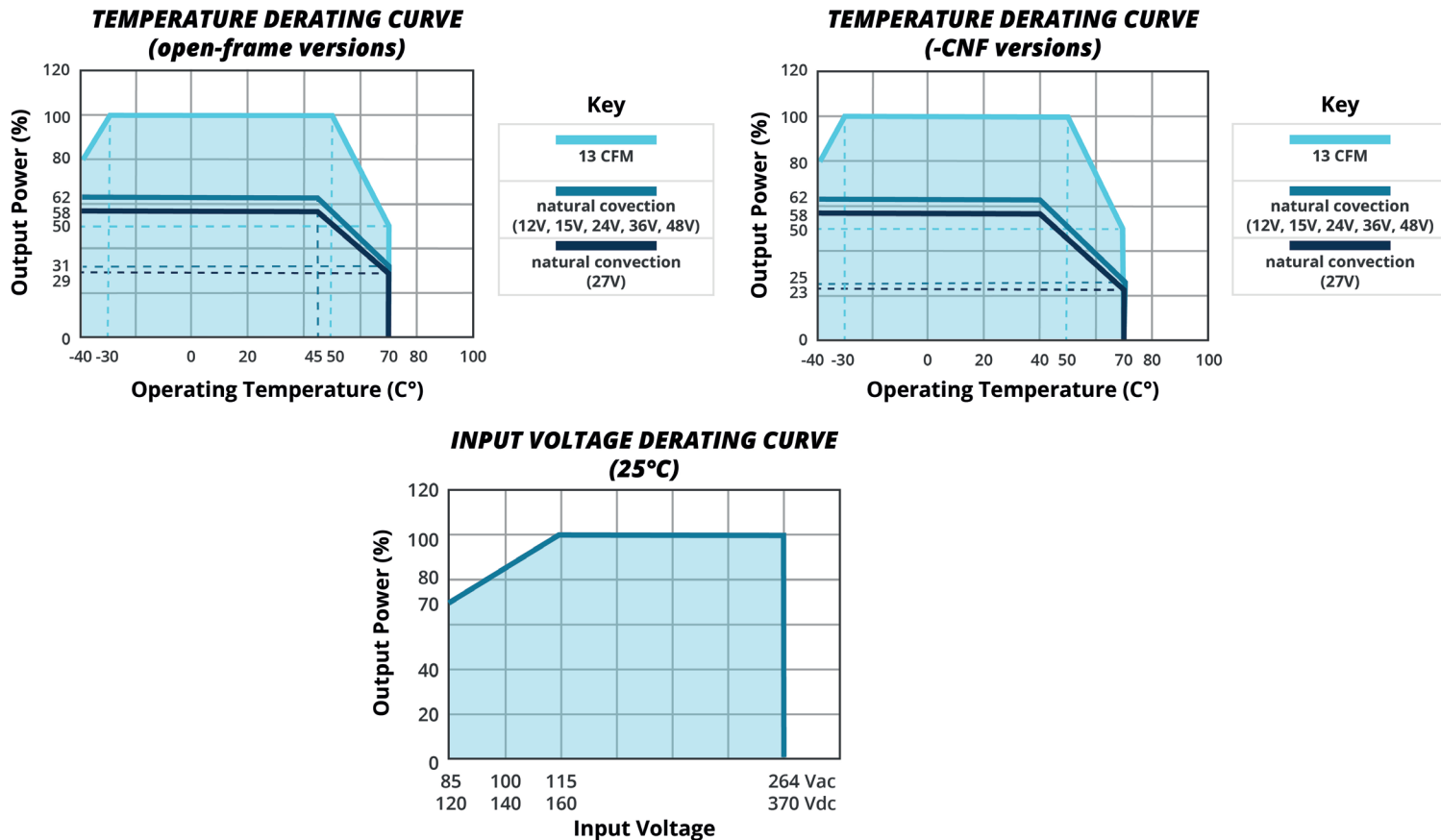

Note: With an AC input voltage between 85 ~ 115 and a DC input between 120 ~ 160 Vdc the output power must be derated as per the temperature derating curve.

EFFICIENCY CURVES

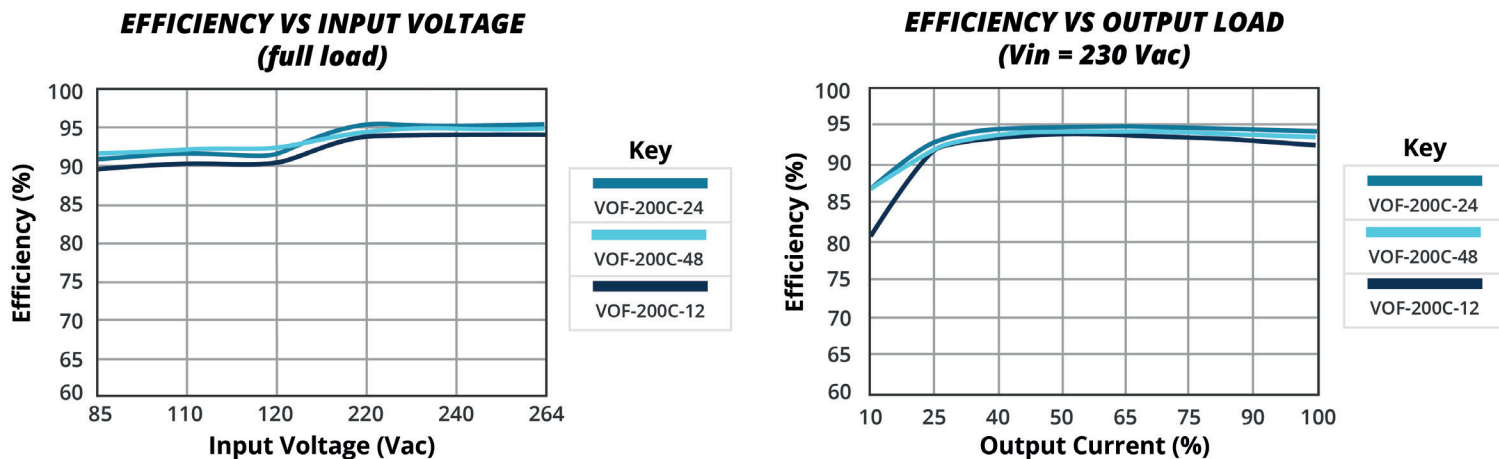

MECHANICAL

parameter	conditions/description	min	typ	max	units
dimensions	open frame models: 101.6 × 50.8 × 25.4 [4.0 × 2.0 × 1.0 inch] covered models: 103.4 × 62.0 × 37.0 [4.070 × 2.440 × 1.456 inch]				mm mm
weight	open frame models covered models		175 260		g g
cooling	natural convection (no integrated fan)				

MECHANICAL DRAWING

Open-frame

units: mm [inch]

general tolerance: ±1.00 [±0.039]

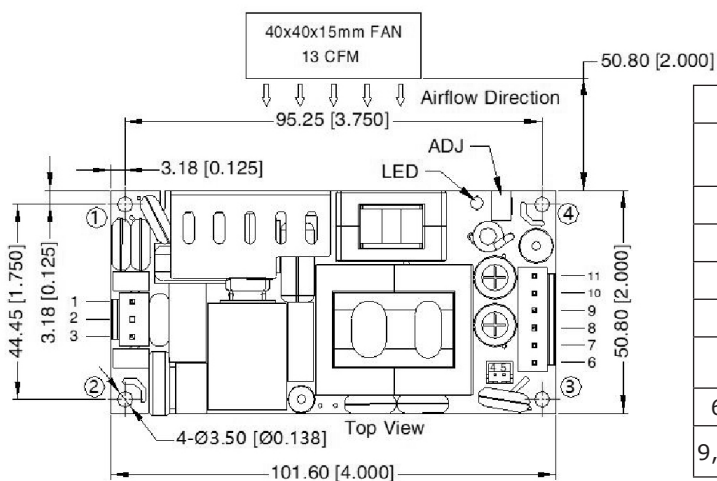

PIN-OUT			
PIN	Function	Product Connector	Customer Connector
1	AC (N)/DC-	JST B3P-VH or equivalent	Housing: JST VHR Contact: JST SVH-21T-P1.1 or equivalent
2	NC		
3	AC (L)/DC+	JST B2B-PH-K-S or equivalent	Housing: JST PHR-2 Contact: JST SPH-002T-P0.5S or equivalent
4	Fan-		
5	Fan+	JST B6P-VH or equivalent	Housing: JST VHR Contact: JST SVH-21T-P1.1 or equivalent
6,7,8	-Vo		
9,10,11	+Vo		

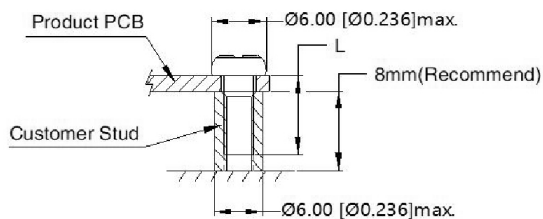
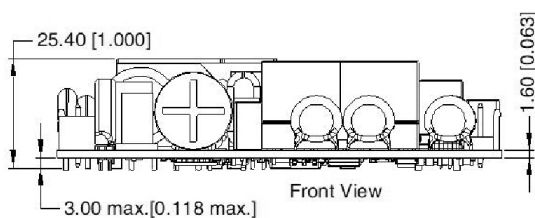

Position	Screw Spec.	L (recommended)	Torque
①~④	M3	6mm	0.4 N·m

Note: 1. Class I system ①, ③ positions must be connected to the protective earth ground (⊕).
2. Class II system ①, ③ positions must be connected together.
3. It is recommended that a minimum distance of 10mm be placed between the PCB edge and all other components.

MECHANICAL DRAWING (CONTINUED)

Covered

units: mm [inch]

general tolerance: ±1.00 [±0.039]

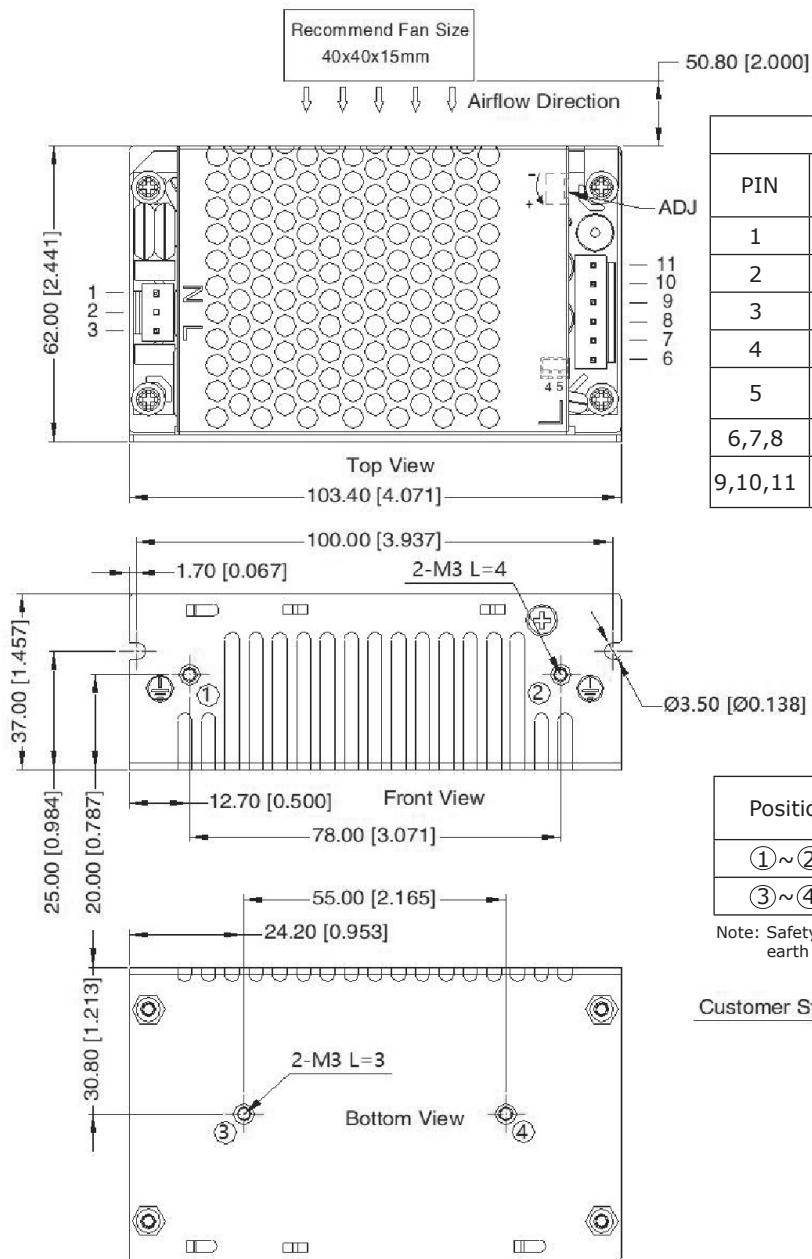

PIN-OUT			
PIN	Function	Product Connector	Customer Connector
1	AC (N)/DC-	JST B3P-VH or equivalent	Housing: JST VHR Contact: JST SVH-21T-P1.1 or equivalent
2	NC		
3	AC (L)/DC+		
4	Fan-	JST B2B-PH-K-S or equivalent	Housing: JST PHR-2 Contact: JST SPH-002T-P0.5S or equivalent
5	Fan+		
6,7,8	-Vo	JST B6P-VH or equivalent	Housing: JST VHR Contact: JST SVH-21T-P1.1 or equivalent
9,10,11	+Vo		

Position	Screw Spec.	L (recommended)	Torque
①~②	M3	4mm	0.4 N·m
③~④	M3	3mm	0.4 N·m

Note: Safety Class I integrations require the metal case to be securely fastened to protective earth ground (⊥).

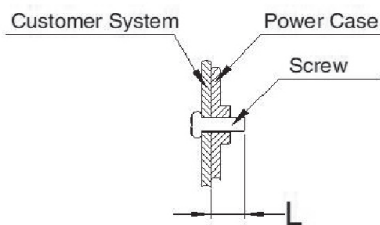

REVISION HISTORY

rev.	description	date
1.0	initial release	06/14/2021
1.01	derating efficiency curves	01/31/2022
1.02	safety approvals updated	03/02/2022
1.03	UKCA mark added	06/13/2022

The revision history provided is for informational purposes only and is believed to be accurate.



CUI INC

a bel group

Headquarters

20050 SW 112th Ave.
Tualatin, OR 97062
800.275.4899

Fax 503.612.2383
cui.com
techsupport@cui.com

CUI offers a two (2) year limited warranty. Complete warranty information is listed on our website.

CUI reserves the right to make changes to the product at any time without notice. Information provided by CUI is believed to be accurate and reliable. However, no responsibility is assumed by CUI for its use, nor for any infringements of patents or other rights of third parties which may result from its use.

CUI products are not authorized or warranted for use as critical components in equipment that requires an extremely high level of reliability. A critical component is any component of a life support device or system whose failure to perform can be reasonably expected to cause the failure of the life support device or system, or to affect its safety or effectiveness.