

Revision Level			Revision Record	Changed	Date	Approved	Date
Drawing	State	Part					
00.0	Design Release	-	SEE ECN# 014926	EJH	2/20/19	TAT	2/21/19

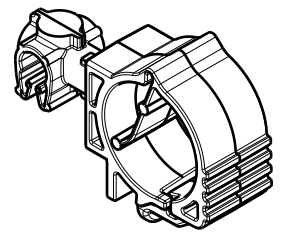

ISOMETRIC VIEW
CLOSED

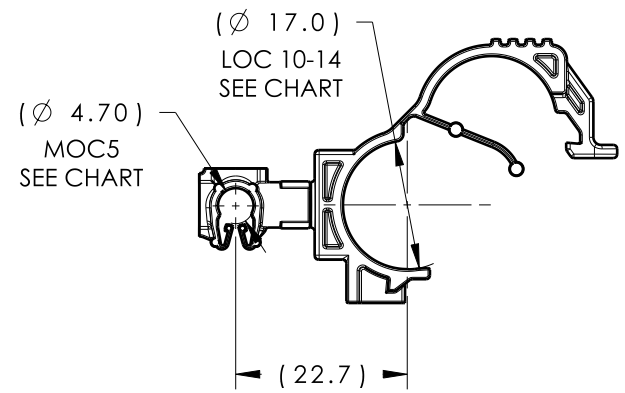
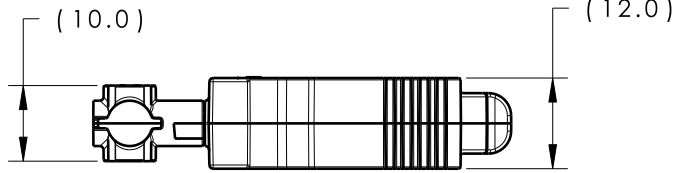
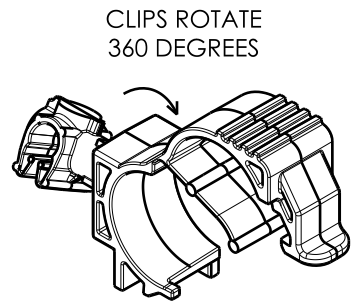

CLIPS ROTATE
360 DEGREES

ISOMETRIC VIEW
OPEN

TYPE	MOC5F
HARNESS	4.5MM-5.3MM
HOSE	4.5MM-5.3MM
HARD PIPE/TUBE	4.8MM-5.5MM

*RECOMMENDED SIZES MAY DIFFER DEPENDING ON THE APPLICATION , PRODUCT REQUIREMENTS AND MATERIALS USED

**PATENT PENDING 29/582,271

GLOBAL PART DESCRIPTION	MOC5**			LOC10-14		
	DRAWING	MATERIAL	COLOR	DRAWING	MATERIAL	COLOR
MOC5LOC10-14-PA66HIRHSUV-BK	16-0313-000-CSU	PA66HIRHSUV	BLACK	11-0594-031-CSU	PA66HIRHSUV	BLACK

Material SEE CHART COLOR: SEE CHART	Units	millimeters	The copyright of this drawing is reserved by HellermannTyton. It is issued on condition that it is not reproduced, copied or disclosed to a third party, either wholly or in part, without the consent of HellermannTyton.	Drawn	EJH	2/20/19	Article/Type-No	MOC5LOC115-19		Scale	1:1
	Tolerance defined on each dimension	Approved		TAT	2/21/19	Title		5mm MOC COUPLED TO A 15-19mm LOC		Project Number	16-0327
		HellermannTyton			Drawing-No		PRODUCTION : Phase		Format	AH	
							16-0327-053-CSU		Sheet	1/1	
North America Email: corp@htamericas.com Web: www.hellermann.tyton.com											