

② USB3.0 COMPLIANT

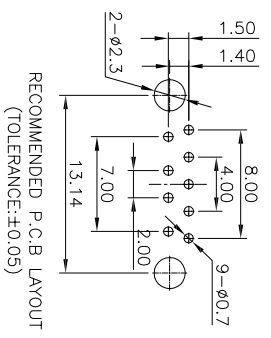
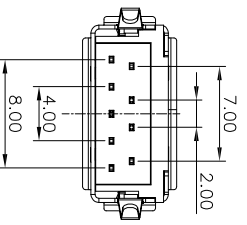
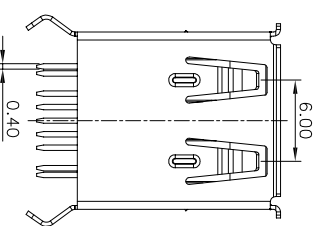
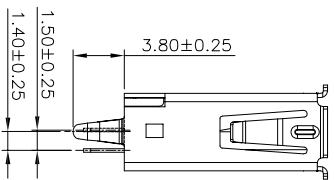
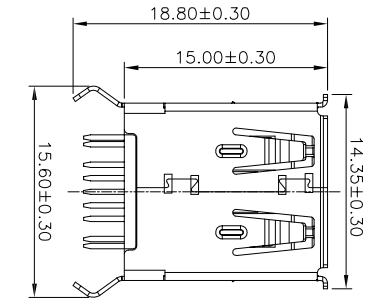
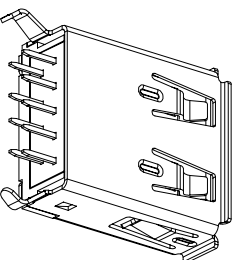
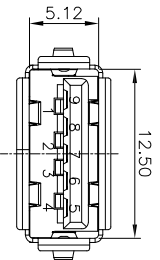

- NOTES:
- MATERIAL:
    - HOUSING: PBT+30%G.F UL94V-0,BLUE COLOR.
    - COVER: PBT+50%G.F UL94V-0,BLUE COLOR.
    - CONTACT: COPPER ALLOY T=0.25MM
    - SHELL: BRASS T=0.30MM
  - FINISH:
    - CONTACT: CONTACT AREA: 15u"Au  
SOLDER AREA: TIN PLATED  
UNDER PLATE: NI PLATED
    - SHELL: NI PLATED
  - MECHANICAL:
    - MATING FORCE: 3.57kgf MAX.
    - UNMATING FORCE: 1.02kgf MIN
    - DURABILITY: 1500 CYCLES MIN
  - ELECTRICAL:
    - CURRENT RATING:1.8A FOR PIN1 TO PIN4.  
0.25A OTHER CONTACTS.
    - DIELECTRIC STRENGTH: 100V AC FOR 1MINUTE.
    - CONTACT RESISTANCE: 20mΩ MAX FOR PIN1 TO PIN4.  
50mΩ MAX OTHER CONTACTS.
    - INSULATION RESISTANCE: 100MΩ MIN
    - OPERATING TEMPERATURE: -55°C TO +85°C.

**RoHS compliant**  
unit:mm

Scale	FREE							
TOLERANCE								
X.X	±0.38							
X.XX	±0.25							
X.XXX	±0.10	②	Add the"USB3.0 COMPLIANT"	24.03.2014	Wlrnlr			
DIM	TOL	①	Update	18.02.2014	Ray			
X.°	±5°	①	Drawn	29.07.2011	Rale			
Angle	TOL							

Date	Name	Customer-No.
29.07.2011	Rale	ASSMANN WSW-No. A-USB3 A-TOP
24.03.2014	Wlrnlr	

Date	Name	Customer-No.
29.07.2011	Rale	ASSMANN WSW-No. A-USB3 A-TOP
24.03.2014	Wlrnlr	

Date	Name	Customer-No.
29.07.2011	Rale	ASSMANN WSW-No. A-USB3 A-TOP
24.03.2014	Wlrnlr	



ASS 4544 CO

rev02

Replace

Sheet

1

2

3

4

5

6

7

SV2451