

FPMR19S3R304PA

8.0-27.6Vdc Input, 4A, 3.0-15.5Vdc Output

Preliminary Data Sheet

The **SENDA3** Series of non-isolated dc-dc converters deliver exceptional electrical and thermal performance in industry-standard footprints for Point-of-Load converters. Operating from a 8.0Vdc-27.6Vdc input, these are the converters of choice for industrial and networking applications that require high efficiency, tight regulation, and high reliability in elevated temperature environments with low airflow.

非絶縁型DC/DCコンバータの **SENDA3** シリーズは業界標準のPOLコンバータと同じ端子配列で極めて優れた電気的特性、及び温度特性を提供します。

入力電圧8.0V~27.6Vで動作しますので、このコンバータは、高効率、高い出力電圧精度、高温、及び風量の少ない環境での高信頼性が要求される産業機器、又は通信系機器での使用に最適です。

The **FPMR19S3R304PA** converter of the **SENDA3** Series delivers 4A of output current at a tightly regulated programmable output voltage of 3.0Vdc to 15.5Vdc. The thermal performance of the **FPMR19S3R304PA** is best-in-class: No derating is needed up to 85°C, under natural convection.

SENDA3 シリーズの **FPMR19S3R304PA**は高い電圧精度で3.0V~15.5Vの可変を実現します。**FPMR19S3R304PA**の温度特性はクラス最高レベルです。自然対流条件で85°Cまで出力電流デレーティングを必要としません。

This leading edge thermal performance results from electrical, thermal and packaging design that is optimized for high density circuit card conditions. Extremely high quality and reliability are achieved through advanced circuit and thermal design techniques and FDK's state of the art in-house manufacturing processes and systems.

回路設計、放熱設計、及びパッケージング設計の結果である最先端の温度特性は、高密度実装回路用に最適化されています。非常に優れた品質と信頼性は高度な回路設計、温度設計技術、及びFDKの最先端の自社製造プロセスによりもたらされます。

Applications

- Industrial
産業機器
- Networking
通信機器

**FPMR19S3R304PA**

Features

- Delivers up to 4A (62W)
4A (62W)まで供給可能
- High efficiency, no heatsink required
高効率-放熱器が不要
- No derating up to 85°C
85°Cまでデレーティング不要
- Positive ON/OFF logic
ON/OFFロジックはポジティブ
- Industry-standard SMD footprint
業界標準のSMDフットプリント
- RoHS compliance
RoHS準拠
- Small size and low profile: 0.80" x 0.45" x 0.211" nominal
小型、低背 (20.3 x 11.4 x 5.35mm)
- Coplanarity less than 0.004"
平面度は0.1mm以下
- Tape & reel packaging
梱包はテーピング仕様
- Programmable output voltage via external resistor
外部接続の抵抗によりプログラム可能な出力電圧
- No minimum load required
最小負荷は不要
- Remote ON/OFF
リモートON/OFF機能
- Power Good Signal
パワーグッド信号出力
- Auto-reset output over-current protection
過電流保護機能: 自動復帰
- UL60950 recognition in U.S. & Canada, and CB Scheme certification per IEC/EN60950 (pending)
UL60950、CB Schemeに準拠
- All materials meet UL94, V-0 flammability rating
全ての部品は UL94 V-0に適合

FPMR19S3R304PA

Preliminary Data Sheet

8.0-27.6Vdc Input, 4A, 3.0-15.5Vdc Output

Electrical Specifications 電氣的仕様

All specifications apply over specified input voltage, output load, and temperature range, unless otherwise noted.

注記が無い場合、全ての仕様は指定された入力電圧、負荷、温度範囲で適用されます。

Conditions: $T_a=25\text{degC}$, $\text{Airflow}=200\text{LFM}(1.0\text{m/s})$, $V_{in}=24\text{Vdc}$, $V_{out}=3.0\sim 15.5\text{Vdc}$, unless otherwise specified.

PARAMETER	NOTES	MIN	TYP	MAX	UNITS
ABSOLUTE MAXIMUM RATINGS¹					
Input Voltage	Continuous	-0.3		30	Vdc
Operating Temperature	Ambient temperature	-40		85	°C
Operating Humidity	Non Condensing	20		85	%RH
Storage Temperature		-55		125	°C
Storage Humidity	Non Condensing	5		95	%RH
Output Voltage		3.0		15.5	Vdc
Power Good Terminal Voltage				30	Vdc
Power Good Sink Current				5	mA
Remote ON/OFF Terminal Voltage				V_{in}	Vdc
Moisture Sensitivity Level		JEDEC Level 2			
FEATURE CHARACTERISTICS					
Switching Frequency			600		kHz
Output Voltage Programming Range	By external resistor. See trim Table-1	3.0		15.5	Vdc
Turn-On Delay Time	Full resistive load				
with V_{in} (converter enabled, then V_{in} applied)	From $V_{in}=V_{in}(\text{min})$ to $0.1*V_{out}(\text{nom})$		1.0		mS
with Enable (V_{in} applied, then enabled)	From enable to $0.1*V_{out}(\text{nom})$		1.0		mS
Rise Time (Full resistive load)	From $0.1*V_{out}(\text{nom})$ to $0.9*V_{out}(\text{nom})$		2.7		mS
ON/OFF Control (Positive)					
Converter Off					
Input Low Voltage		0.0		0.5	Vdc
Input Low Current				0.03	mA
Converter On					
Input High Voltage		2.0		V_{in}	Vdc
Input High Current		0.2			mA
Power Good	Set point for power good output high	90.0	94.5	97.5	%Vout
	Set point for power good output low	88.0	92.0	94.5	%Vout
Power Good Output Low	$I_{PGOOD}=2\text{mA}$			0.4	V
Power Good Leakage Current	Power Good Terminal Voltage= 27.6V			1	uA

¹Absolute Maximum Ratings 絶対最大定格

Stresses in excess of the absolute maximum ratings may lead to degradation in performance and reliability of the converter and may result in permanent damage.

絶対最大定格を超えたストレスは、性能の低下、長期信頼性の低下、及びモジュールの破損を引き起こすことがあります。

FPMR19S3R304PA

Preliminary Data Sheet

8.0-27.6Vdc Input, 4A, 3.0-15.5Vdc Output

Electrical Specifications (Continued) 電氣的仕様 (続き)

Conditions: Ta=25degC, Airflow=200LFM(1.05m/s), Vin=24Vdc, Vout=3.0~15.5Vdc, unless otherwise specified.

PARAMETER	NOTES	MIN	TYP	MAX	UNITS
INPUT CHARACTERISTICS					
Operating Input Voltage Range	Vout ≤ 5.0V	8.0	24.0	27.6	Vdc
	5.0 < Vout ≤ 12.0V	16.0	24.0	27.6	Vdc
	Vout > 12.0V	20.4	24.0	27.6	Vdc
Input Under Voltage Lockout					
Turn-on Threshold		6.9	7.4	8.0	Vdc
Turn-off Threshold		6.0	6.5	6.9	Vdc
Maximum Input Current					
	4Adc out				
	Vout=15.0Vdc (20.4Vdc in)			3.20	Adc
	Vout=12.0Vdc (16.0Vdc in)			3.25	Adc
	Vout=8.0Vdc (12.0Vdc in)			2.90	Adc
	Vout=6.5Vdc (10.0Vdc in)			2.85	Adc
	Vout=5.0Vdc (8.0Vdc in)			2.75	Adc
	Vout=3.3Vdc (8.0Vdc in)			1.90	Adc
Input Stand-by Current (converter disabled)	Vin=24V		3.2		mA
Input No Load Current					
	Vout=15.0Vdc		38		mA
	Vout=12.0Vdc		41		mA
	Vout=8.0Vdc		35		mA
	Vout=6.5Vdc		30		mA
	Vout=5.0Vdc		25		mA
	Vout=3.3Vdc		22		mA
Input Reflected-Ripple Current					
	See Fig.E for setup (BW=20MHz)				
	Vout=15.0Vdc		32		mAp-p
	Vout=12.0Vdc		31		mAp-p
	Vout=8.0Vdc		28		mAp-p
	Vout=6.5Vdc		25		mAp-p
	Vout=5.0Vdc		23		mAp-p
	Vout=3.3Vdc		18		mAp-p

FPMR19S3R304PA
Preliminary Data Sheet

8.0-27.6Vdc Input, 4A, 3.0-15.5Vdc Output

Electrical Specifications (Continued) 電氣的仕様 (続き)

 Conditions: $T_a=25\text{degC}$, Airflow=200LFM(1.05m/s), $V_{in}=24\text{Vdc}$, $V_{out}=3.0\sim 15.5\text{Vdc}$, unless otherwise specified.

PARAMETER	NOTES	MIN	TYP	MAX	UNITS
OUTPUT CHARACTERISTICS					
Output Voltage Set Point (no load)		-2.5	Vout	+2.5	%Vout
Output Regulation					
Over Line	Full resistive load		+/- 0.1		%Vout
Over Load	From no load to full load		+/- 0.3		%Vout
Output Voltage Range (Over all operating input voltage, resistive load and temperature conditions until end of life)	Output Ripple is not included.	-3.0		+3.0	%Vout
Output Overshoot				3.0	%Vout
Output Ripple and Noise BW=20MHz	See Fig. D for set up				
Peak to Peak	Vout=3.3Vdc		20	50	mVp-p
Peak to Peak	Vout=15.0Vdc		50	100	mVp-p
External Load Capacitance	Ceramic Capacitor, $V_{out}\leq 8.0\text{V}$	45		1000	μF
	Ceramic Capacitor, $V_{out}> 8.0\text{V}$	45		500	μF
Output Current Range		0		4.0	A
Output Current Limit Inception (Iout)	Vout=15Vdc		5.6		A
Output Short-Circuit Current	Short=10m Ω , Vout=15Vdc Set		1.5		Arms
Over Voltage Protection	Vout=15.5Vdc		20.0		Vdc
DYNAMIC RESPONSE					
Iout step from 2.0A to 4.0A with di/dt=5A/ μS	Co=22 μF x 2 ceramic + 1 μF ceramic		375		mV
Setting time (Vout < 10% peak deviation)			120		μS
Iout step from 4.0A to 2.0A with di/dt=-5A/ μS	Co=22 μF x 2 ceramic + 1 μF ceramic		375		mV
Setting time (Vout < 10% peak deviation)			120		μS
EFFICIENCY					
	Full load (4A)				
	Vout=15.0Vdc		95.5		%
	Vout=12.0Vdc		94.5		%
	Vout=8.0Vdc		92.5		%
	Vout=6.5Vdc		91.0		%
	Vout=5.0Vdc		89.5		%
	Vout=3.3Vdc		85.5		%

FPMR19S3R304PA

8.0-27.6Vdc Input, 4A, 3.0-15.5Vdc Output

Preliminary Data Sheet

Operation

Input and Output Impedance

The **FPMR19S3R304PA** converter should be connected to a DC power source using a low impedance input line. In order to counteract the possible effect of input line inductance on the stability of the converter, the use of decoupling capacitors placed in close proximity to the converter input pins is recommended. This will ensure stability of the converter and reduce input ripple voltage. Although low ESR Tantalum or other capacitors should typically be adequate, very low ESR capacitors (ceramic, over 20uF) are recommended to minimize input ripple voltage. The converter itself has on-board internal input capacitance of 5uF with very low ESR (ceramic).

FPMR19S3R304PAと入力電源間は低インピーダンスで接続してください。コンバータの安定性に影響のある入力インダクタンスを抑えるため、コンバータの入力ピンの近傍にデカップリングコンデンサを付加することをお勧めします。これによりコンバータの安定動作を確実にし、入力リップル電圧を抑制します。低ESRタンタル、又はその他のコンデンサも一般的には問題ありませんが、入力リップルを最小にするためには、非常に低ESRコンデンサ(セラミックで20uF以上)を推奨します。コンバータ自身は入力回路に極低ESRの5uFセラミック入力コンデンサを搭載しています。

The **FPMR19S3R304PA** requires minimum 45uF external capacitance on the output. To minimize output ripple voltage, the use of very low ESR ceramic capacitors is recommended. These capacitors should be placed in close proximity to the load to improve transient performance and to decrease output voltage ripple.

FPMR19S3R304PAは出力に45uFの外付けコンデンサが必要です。出力リップルを最小にするため、極低ESRのセラミックコンデンサの接続を推奨します。過渡時の特性向上と出力リップル低減のために負荷の近傍に極低ESRセラミックコンデンサを実装することをお勧めします。

Note that the converter does not have a SENSE pin to counteract voltage drops between the output pins and the load. The impedance of the line from the converter output to the load should thus be kept as low as possible to maintain good load regulation.

このコンバータは出力端子と負荷間の電圧ドロップを補正するセンス端子を設けていません。精度の高い負荷特性を保持するために、コンバータの出力から負荷までのラインインピーダンスは可能な限り低くしてください。

Remote ON/OFF (Pin 5)

The Remote pin (pin 5) can be used to turn the converter on or off remotely using a signal that is referenced to GND (pin 2).

The **FPMR19S3R304PA** turns on when the Remote pin is at logic high and turns off when it is at logic low. The recommended circuit is shown in Fig.A. The pull up resistor R* to Vin is 22kohm. If the on/off circuit is different from Fig. A, please consult FDK.

When the Remote on/off is not used, the remote pin must be pulled up to Vin with 22kohm resistor. Voltage ranges for logic high/low are provided in the Electrical Specifications section.

ON/OFF端子(5番ピン)はグラウンド(2番ピン)を基準としたリモート信号によりコンバータをON/OFFするのに使われます。

FPMR19S3R304PA*はリモート端子が論理的にHighで動作し、論理的にLowで停止します。

図-Aは推奨回路です。プルアップ抵抗R*は22kΩをお使いください。

ON/OFF回路が図-Aと違う場合はFDKにご相談ください。

リモートON/OFF機能を使用しない場合、リモート端子をVinに22kΩの抵抗でプルアップしてください。

論理的High/Lowの電圧範囲は電気的特性を参照してください。

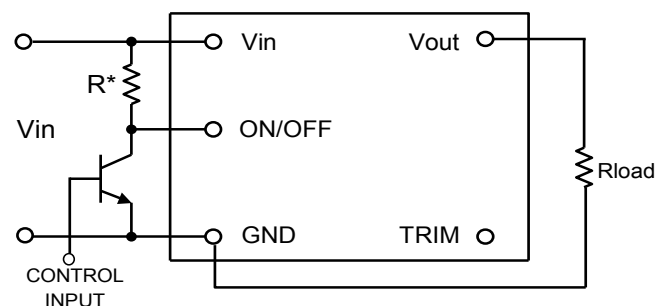

Fig. A: Recommended circuit for remote ON/OFF

Power Good (Pin 6)

The Power Good Signal is an open-drain output that asserts low when Vout is out of regulation. Power Good can be pulled up to Input, Output or external voltage source, but the voltage must be less than 30Vdc. And the sink current should be less than 5mA during low state.

パワーグッド信号はオープンドレイン出力で、出力電圧が確定していない状態ではLowとなります。入力、出力及び外部電源等にプルアップして使用することが出来ますが、High時にPower Good端子の電圧が30Vを超えない様にして下さい。また、Low時のシンク電流が5mAを超えない様に使用してください。

FPMR19S3R304PA

8.0-27.6Vdc Input, 4A, 3.0-15.5Vdc Output

Preliminary Data Sheet

Output Voltage Programming (Pin 3)

The output voltage of the **FPMR19S3R304PA** converter can be programmed from 3.0V to 15.5V by using an external resistor.

FPMR19S3R304PAの出力電圧は外部抵抗を接続することで 3.0V～15.5Vまで可変可能です。

External Resistor

An external trim resistor, R_{TRIM} , should be connected between TRIM (pin 3) and GND (pin 2); see Fig. B. The value of R_{TRIM} , in $k\Omega$, for a desired output voltage, V_{O-REQ} , in V, is given by:

外部抵抗 R_{TRIM} はTRIM端子(3番ピン)とGND端子(2番ピン)の間に接続してください。図Bを参照。 R_{TRIM} の定数、及び必要な出力電圧は次の式により求めます。

$$R_{TRIM} = \frac{44.325}{(V_{O-REQ} - 3.0)} - 3 \text{ [k}\Omega\text{]}$$

Note that the tolerance of a trim resistor will affect the tolerance of the output voltage. Standard 1% or 0.5% resistors may suffice for most applications; however, a tighter tolerance can be obtained by using two resistors in series instead of one standard value resistor.

Table 1 lists calculated values of R_{TRIM} for common output voltages. For each value of R_{TRIM} , Table 1 also shows the closest available standard resistor value.

R_{TRIM} の公差は出力電圧の公差に影響します。ほとんどの使用状況においては、標準的な1%又は0.5%品の抵抗で十分です。しかしながら、より厳しい出力精度のためには、抵抗1本よりも2本を直列に使用します。Table 1に一般的な出力電圧を設定する際の抵抗値を表示します。またTable 1に標準的な抵抗を使用した場合の近似値も表示しています。

Table 1: Trim Resistor Value		
V_{O-REQ} [V]	R_{TRIM} [k Ω]	The Closest Standard Value [k Ω]
3.3	144.75	130+15
5.0	19.16	18+1.2
6.5	9.66	9.1+0.56
8.0	5.87	5.6+0.27
12.0	1.93	1.8+0.12
15.0	0.69	0.68+0.013

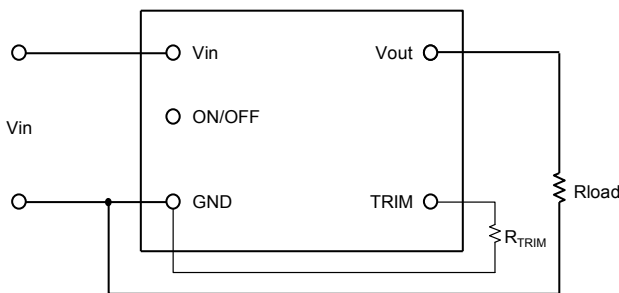

Fig. B: Configuration for programming output voltage

FPMR19S3R304PA

Preliminary Data Sheet

8.0-27.6Vdc Input, 4A, 3.0-15.5Vdc Output

Recommended Circuit

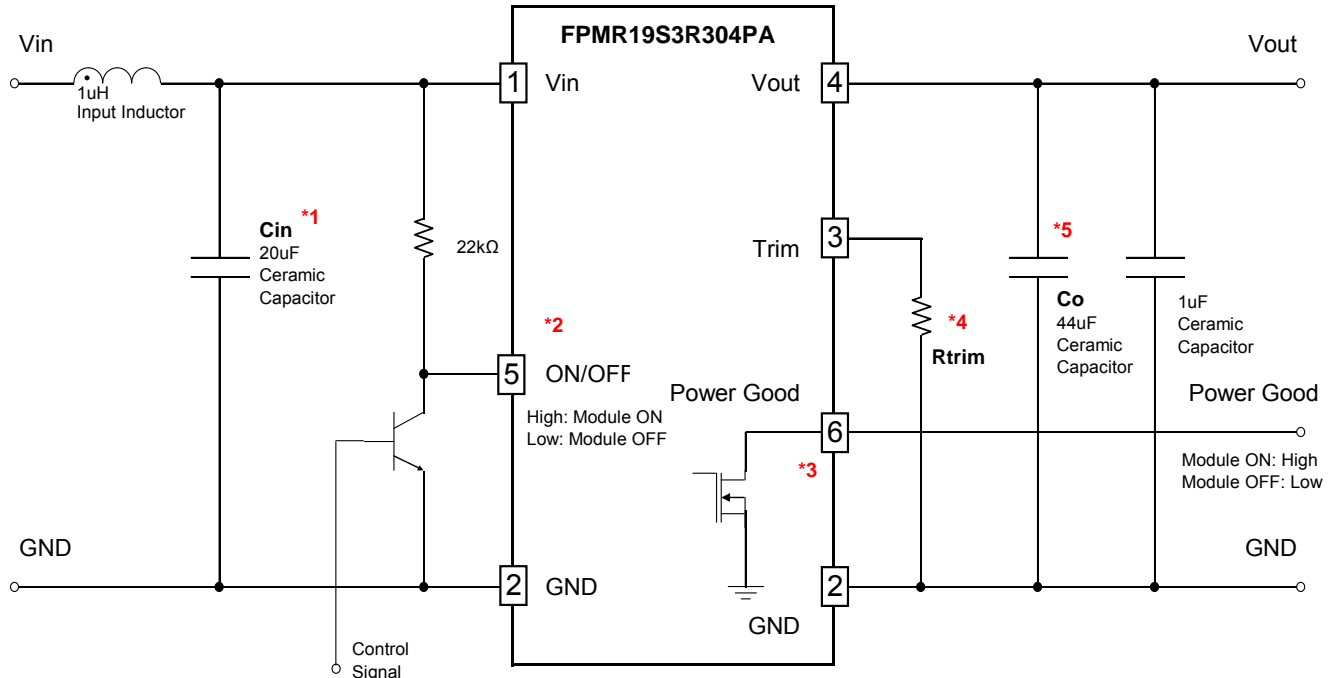

***1: Cin, Input Capacitor**

Minimum 10uF x 2. Recommend low ESR ceramic capacitor.
最低10uFx2個つけてください。ESRの低いセラミックコンデンサを推奨します。

***2: Remote ON/OFF**

When the Remote on/off is not used, the remote pin must be pulled up to Vin with 22kohm resistor.
ON/OFF機能を使用しない場合はON/OFF端子をVinに22kΩの抵抗でプルアップして下さい。

***3: Power Good**

When the Power Good signal is not used, the Power Good pin can be left open.
Power Good信号を使用しない場合は未接続でも可能です。

***4: Trim Resistor**

Select trim resistor value using trim equation on page 6.
6ページのトリム抵抗計算式を用いて抵抗値を計算してください。

***5: Co, Output Capacitor**

Minimum 22uF x 2. Recommend low ESR ceramic capacitor.
最低22uFx2個つけてください。ESRの低いセラミックコンデンサを推奨します。

FPMR19S3R304PA

8.0-27.6Vdc Input, 4A, 3.0-15.5Vdc Output

Preliminary Data Sheet

Protection Features

Input Under-Voltage Lockout

From a turned-on state, the converter will turn off automatically when the input voltage drops below typically 6.5V. It will then turn on automatically when the input voltage reaches typically 7.4V.

動作している状態で入力電圧がTYPで6.5V未満になると、このコンバータは自動的に停止します。また、入力電圧がTYPで7.4V以上になると、このコンバータは自動的に動作を開始します。

Output Over-Current Protection (OCP)

The converter is self-protected against over-current and short circuit conditions. On the occurrence of an over-current condition, the converter will enter a pulse-by-pulse hiccup mode. On the removal of the over-current or short circuit condition, Vout will return to the original value (auto-reset).

このコンバータは過電流と短絡に対し自己保護します。過電流状態になると、このコンバータはパルス・バイ・パルス HICCUPモードになり、過電流状態が解除されるとVoutは通常の値に戻ります。(自動リセット)

Over-Voltage Protection (OVP)

The converter is self-protected against over-voltage condition. On the occurrence of an over-voltage condition, the converter will enter a pulse-by-pulse hiccup mode. On the removal of the over-voltage condition, Vout will return to the original value (auto-reset).

このコンバータは過電圧に対し自己保護します。過電圧状態になると、このコンバータはパルス・バイ・パルス HICCUPモードになり、過電圧状態が解除されるとVoutは通常の値に戻ります。(自動リセット)

Safety Requirements

The converter complies with North American and International safety regulatory requirements per UL60950 and EN60950. The converter meets SELV (safety extra-low voltage) requirements under normal operating conditions in that the output voltages are ELV (extra-low voltage) when all the input voltages are ELV. Note that the converter is not internally fused: for protection, a fast acting in-line fuse with a maximum rating of 5A must be used in the positive input line.

このコンバータはUL60950とEN60950による北米、及び国際的な安全基準に準拠しています。このコンバータは通常の動作条件下においてSELVの条件を満たしており、入力電圧がELVであれば出力電圧もELVとなります。但し、このコンバータは内部にヒューズを持っていませんので、異常時の安全な保護の為、入力ラインのプラス側に即断型で最大定格5Aのヒューズを接続してください。

Characterization

Overview

The converter has been characterized for several operational features, including thermal derating (maximum available load current as a function of ambient temperature and airflow), efficiency, power dissipation, start-up and shutdown characteristics, ripple and noise, and transient response to load step-changes.

このコンバータは温度デレーティング、効率、電力損失、スタートアップ時、及びシャットダウン時の動作、リップル・ノイズ、動的負荷変動などを含む、さまざまな動作状態で特徴付けられます。

Figures showing data plots and waveforms for different output voltages are presented in the following pages.

各出力電圧時のデータ、及び波形の図は以後のページに掲載されていません。

Test Conditions

To ensure measurement accuracy and reproducibility, all thermal and efficiency data were taken with the converter soldered to a standardized thermal test board. The thermal test board was mounted inside FDK's custom wind tunnel to enable precise control of ambient temperature and airflow conditions.

測定精度、及び再現性を確実にするために、全ての温度、及び効率データは標準化された温度評価ボードにコンバータを半田付けして取得しています。温度評価ボードをFDK特性の風洞実験設備内に設置することで、環境温度、及び風量を精密に管理しています。

The thermal test board comprised a four layer printed circuit board (PCB) with a total thickness of 0.060". Copper metallization on the two outer layers was limited to pads and traces needed for soldering the converter and peripheral components to the board. The two inner layers comprised power and ground planes of 2 oz. copper. This thermal test board, with the paucity of copper on the outer surfaces, limits heat transfer from the converter to the PCB, thereby providing a worst-case but consistent set of conditions for thermal measurements.

温度評価ボードは厚さ0.060"(1.6mm)厚の4層PCBで作成しています。表面2層の銅箔はコンバータを実装するためのパッドと周辺部品へのパターンのみに限定しています。内側2層は70umの銅箔で電力、及びグラウンドラインを形成しています。このように表層の銅箔を限りなく少なくした温度評価ボードは、コンバータからPCBへの熱の逃げを制限し、ワーストケースでありながら矛盾の無い温度評価条件を実現しています。

FPMR19S3R304PA

8.0-27.6Vdc Input, 4A, 3.0-15.5Vdc Output

Preliminary Data Sheet



FDK Original Wind Tunnel

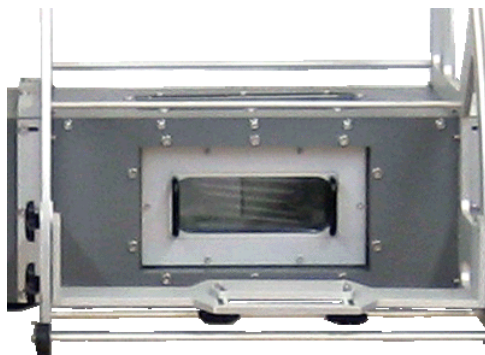

Test Chamber

FDK's custom wind tunnel was used to provide precise horizontal laminar airflow in the range of 50 LFM (equivalent to natural convection, NC) to 600LFM, at ambient temperatures between 30°C and 85°C. Infrared (IR) thermography and thermocouples were used for temperature measurements.

FDK特製の風洞実験装置は水平方向の層流を50LFM(自然対流と同等、NC)から600LFMまで精密に制御でき、環境温度は30°Cから85°Cを制御できます。温度測定には赤外線(IR)サーモグラフィと熱電対を使用しています。

It is advisable to check the converter temperature in the actual application, particularly if the application calls for loads close to the maximums specified by the derating curves. IR thermography or thermocouples may be used for this purpose. In the latter case, AWG#40 gauge thermocouples are recommended to minimize interference and measurement error. An optimum location for placement of a thermocouple is indicated in Fig. C.

コンバータの温度を実際の使用環境で測定することをお勧めします。特に実使用上の負荷が温度デレーティングの最大値に近い場合は測定が必要です。温度測定には赤外線サーモグラフィ、又は熱電対をお使いいただけます。熱電対を使用する場合、風の妨げになることを防ぐためと、測定誤差を少なくするため、AWG40の熱電対を推奨します。熱電対での測定に最適な箇所は図Cに示します。

Thermal Derating

Fig 1 shows the maximum available load current vs. ambient temperature and airflow rates. Ambient temperature was varied between 30°C and 85°C, with airflow rates from NC (50 LFM, 0.25m/s) to 400 LFM (2.0m/s).

The converter was mounted horizontally, and the airflow was parallel to the long axis of the converter, going from pin 1 to pin 5.

図 1はある環境温度と風量の条件下における最大出力電流を表します。環境温度は風量NC (50LFM)~400LFMの条件で30°C~85°Cの間を変動させています。

コンバータは水平に設置し、風向きはコンバータの長手方向に平行で1番ピンから5番ピンに向けています。

The maximum available load current, for any given set of conditions, is defined as the lower of:

- (i) The output current at which the temperature of any component reaches 120°C, or
- (ii) The current rating of the converter (4A)

各々の測定条件で最大出力電流の値は下記のとおり定義します。

- (i) いずれかの部品の温度が120°Cに到達した時点の出力電流値又は
- (ii) コンバータの公称定格電流 (4A)

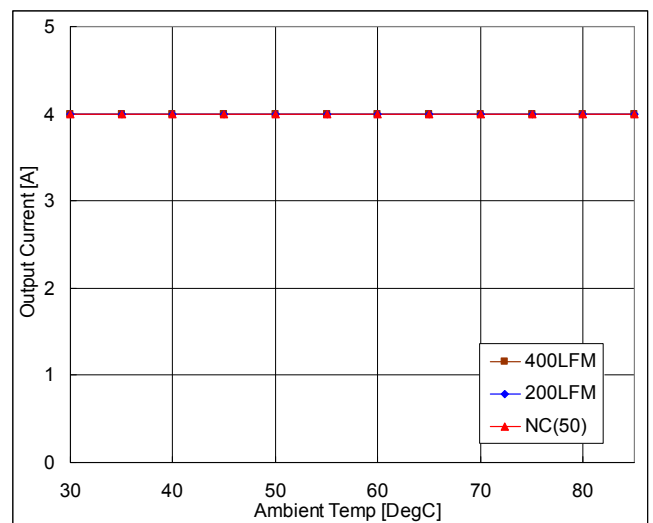

Fig. 1: Output current vs. ambient temperature and air velocity at 24Vin, 3.3V to 15Vout

FPMR19S3R304PA

8.0-27.6Vdc Input, 4A, 3.0-15.5Vdc Output

Preliminary Data Sheet

A maximum component temperature of 120°C should not be exceeded in order to operate within the derating curves. Thus, the temperature at the thermocouple location shown in Fig. C should not exceed 120°C in normal operation.

温度デレーティングの範囲内で動作させるために、部品温度は120°Cを超えないようにご注意ください。従って、通常動作時に図Cに示す位置の熱電対の温度が120°Cを超えないようにしてください。

In case the application requires high reliability or operates continuously for a long term, a maximum component temperature of 85°C should not be exceeded. Exposure to temperature more than 85°C for extended periods may affect converter reliability.

高信頼性が要求される装置での使用や、長時間連続動作する様なご使用方法の場合は、85°Cを超えない範囲で使用して下さい。85°Cを超える状態での長時間動作は、本製品の信頼性に影響を与えることがあります。

Note that continuous operation beyond the derated current as specified by the derating curves may lead to degradation in performance and reliability of the converter and may result in permanent damage.

出力電流デレーティングカーブで指定された定格電流を超えた連続した操作は、性能の低下、信頼性の低下、及びモジュールの破損を引き起こすことがあります。

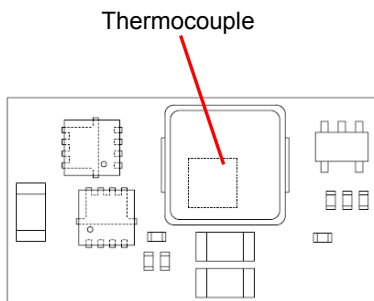

Fig. C: Location of the thermocouples for thermal

Ripple and Noise

The test circuit setup shown in Fig D was used to obtain the output voltage ripple. And Fig. E was used to obtain the input reflected ripple current waveforms. The output voltage ripple waveform was measured across a 1uF ceramic capacitor at full load current.

図Dに示す試験回路は出力リップルの測定に使用しており、入力リップルの測定には図Eの試験回路を使用しています。全ての出力リップル波形は1uFのセラミックコンデンサを通して測定しています。

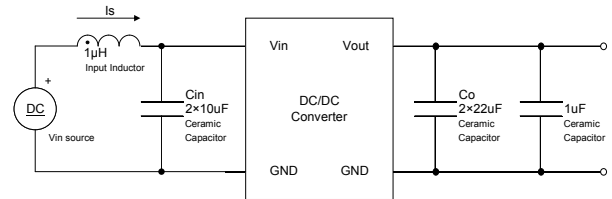

Fig. D: Test setup for measuring output voltage ripple

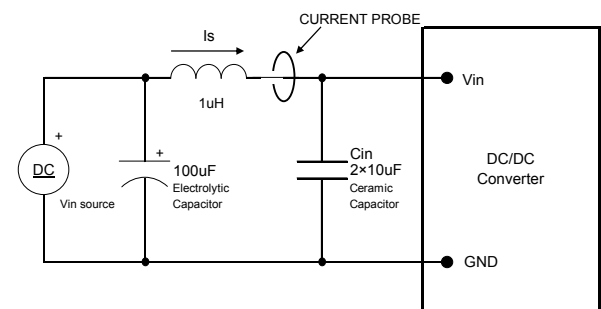

Fig. E: Test setup for measuring input reflected ripple current

FPMR19S3R304PA

8.0-27.6Vdc Input, 4A, 3.0-15.5Vdc Output

Preliminary Data Sheet

Efficiency

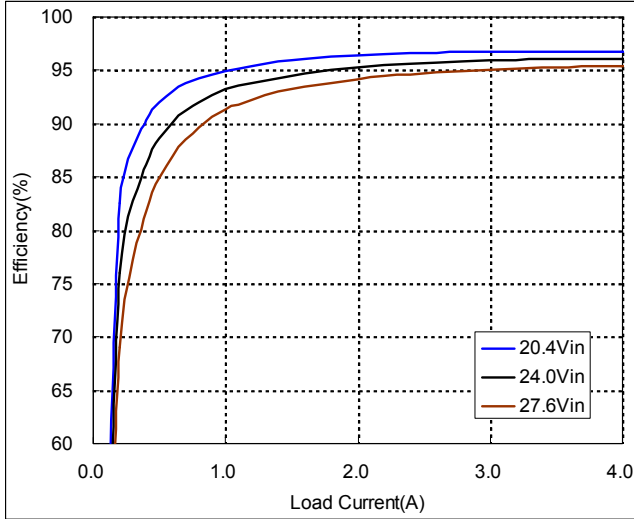

Fig. 2: Efficiency vs. load current and input voltage for Vout=15V.

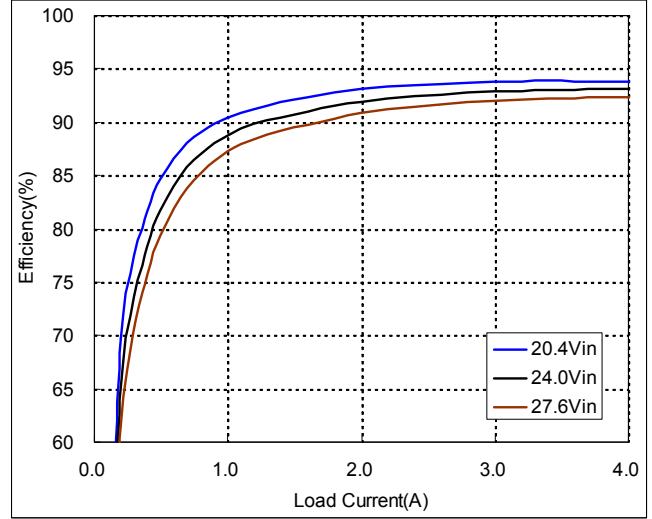

Fig. 3: Efficiency vs. load current and input voltage for Vout=8V.

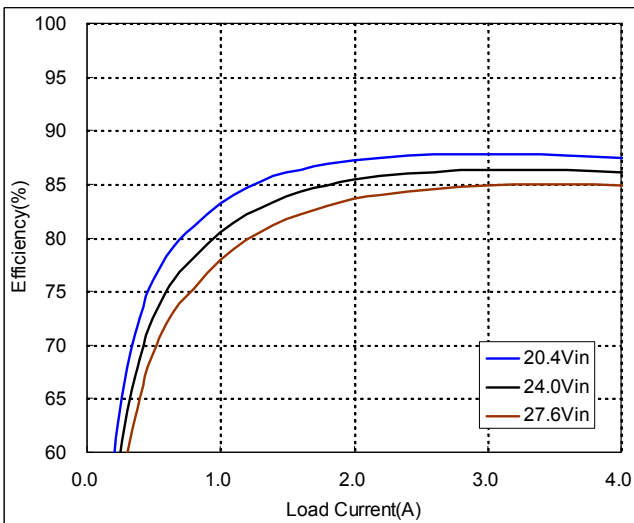

Fig. 4: Efficiency vs. load current and input voltage for Vout=3.3V.

FPMR19S3R304PA

8.0-27.6Vdc Input, 4A, 3.0-15.5Vdc Output

Preliminary Data Sheet

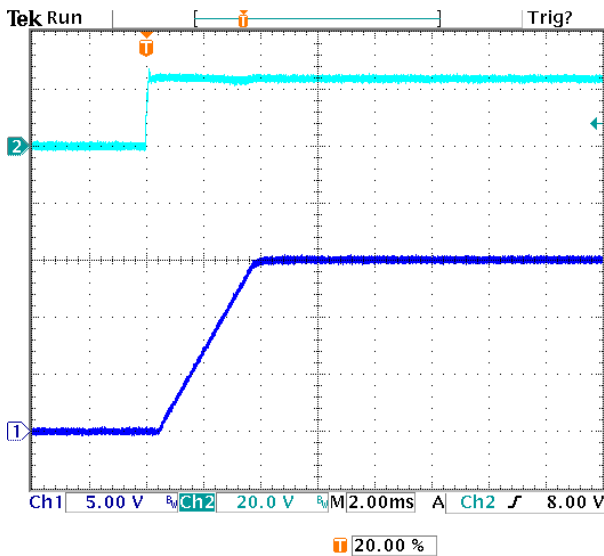

Fig. 5: Turn-on transient for $V_{out}=15V$ with application of V_{in} at full rated load current (resistive) and $22\mu F \times 2 + 1\mu F$ external capacitance at $V_{in}=24V$.
 Top trace: V_{in} (20V/div.)
 Bottom trace: output voltage (5V/div.)
 Time scale: 2 ms/div.

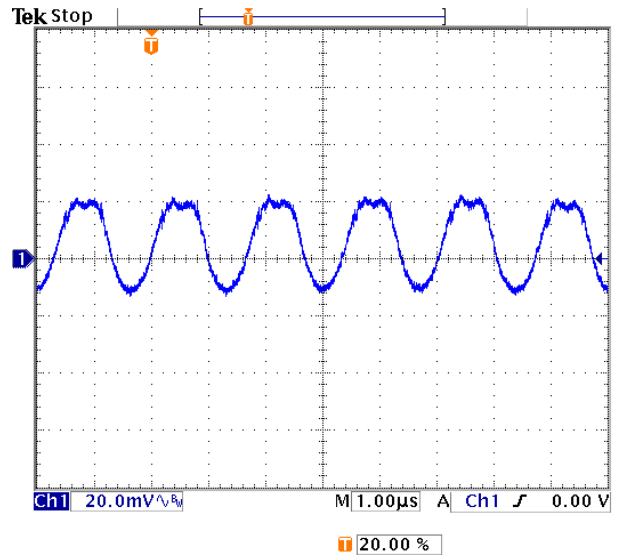

Fig. 6: Output voltage ripple (20mV/div.) for $V_{out}=15V$ at full rated load current into a resistive load with external capacitance $22\mu F \times 2$ ceramic + $1\mu F$ ceramic at $V_{in}=24V$.
 Time scale: 1 us/div.

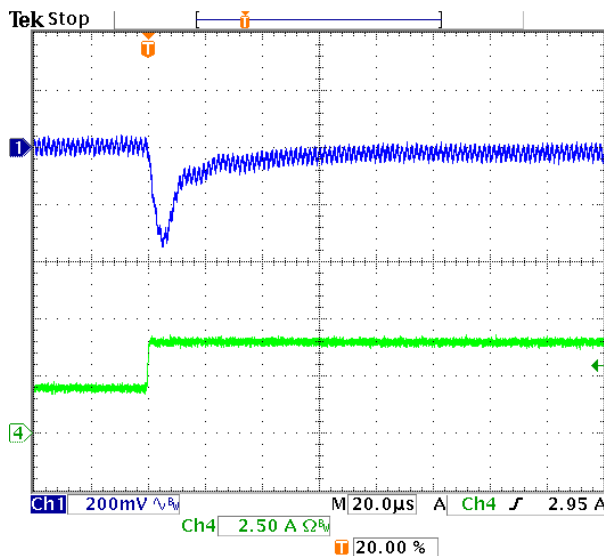

Fig. 7: Output voltage response for $V_{out}=15V$ to positive load current step change from 2A to 4A with slew rate of $5A/\mu s$ at $V_{in}=24V$. $C_o=22\mu F \times 2$ ceramic + $1\mu F$ ceramic.
 Top trace: output voltage (200mV/div.)
 Bottom trace: load current (2A/div.)
 Time scale: 20us/div.

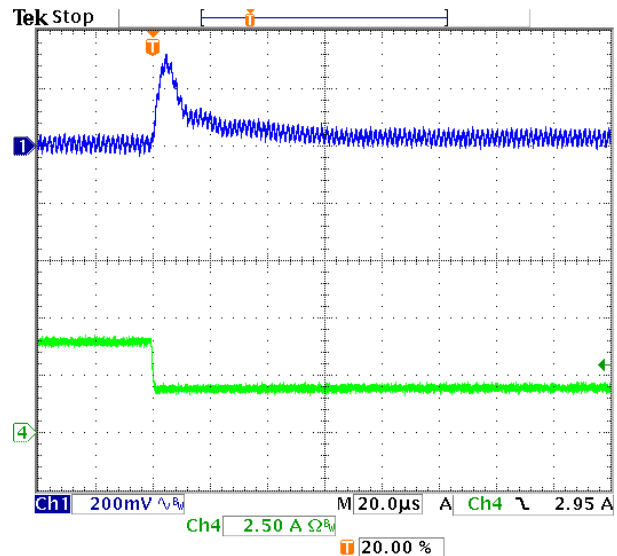

Fig. 8: Output voltage response for $V_{out}=15V$ to negative load current step change from 4A to 2A with slew rate of $-5A/\mu s$ at $V_{in}=24V$. $C_o=22\mu F \times 2$ ceramic + $1\mu F$ ceramic.
 Top trace: output voltage (200mV/div.)
 Bottom trace: load current (2A/div.)
 Time scale: 20us/div.

FPMR19S3R304PA

8.0-27.6Vdc Input, 4A, 3.0-15.5Vdc Output

Preliminary Data Sheet

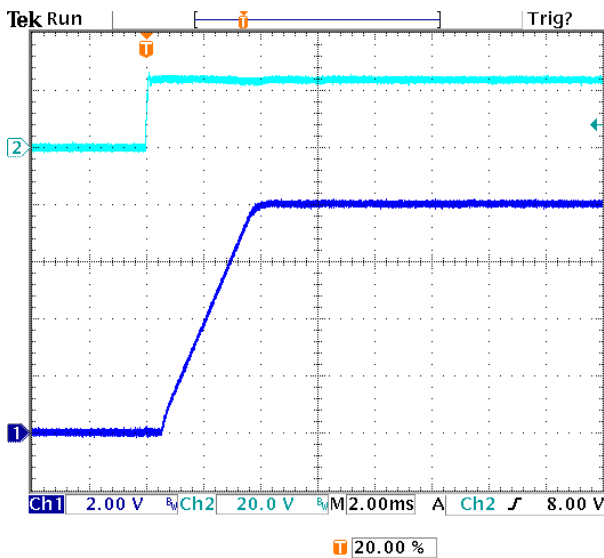

Fig. 9: Turn-on transient for $V_{out}=8V$ with application of V_{in} at full rated load current (resistive) and $22\mu F \times 2 + 1\mu F$ external capacitance at $V_{in}=24V$.

Top trace: V_{in} (20V/div.)
 Bottom trace: output voltage (2V/div.)
 Time scale: 2 ms/div.

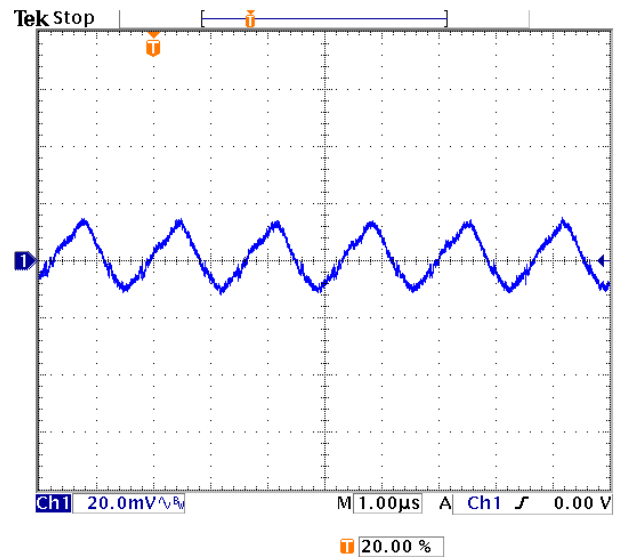

Fig. 10: Output voltage ripple (20mV/div.) for $V_{out}=8V$ at full rated load current into a resistive load with external capacitance $22\mu F \times 2$ ceramic + $1\mu F$ ceramic at $V_{in}=24V$.

Time scale: 1 us/div.

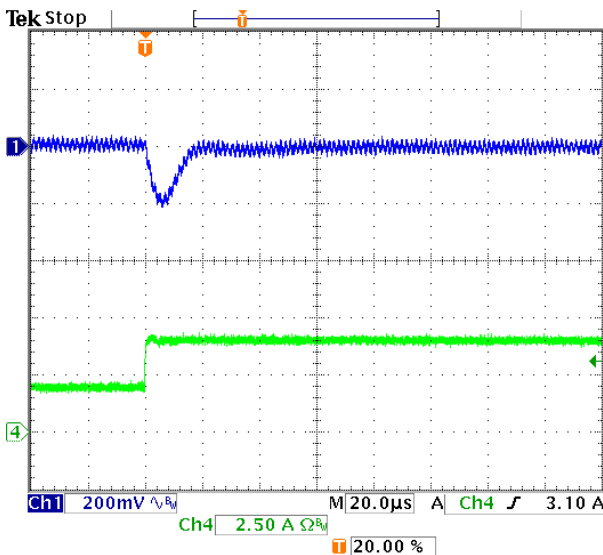

Fig. 11: Output voltage response for $V_{out}=8V$ to positive load current step change from 2A to 4A with slew rate of $5A/\mu s$ at $V_{in}=24V$. $C_o=22\mu F \times 2$ ceramic + $1\mu F$ ceramic.

Top trace: output voltage (200mV/div.)
 Bottom trace: load current (2A/div.)
 Time scale: 20us/div.

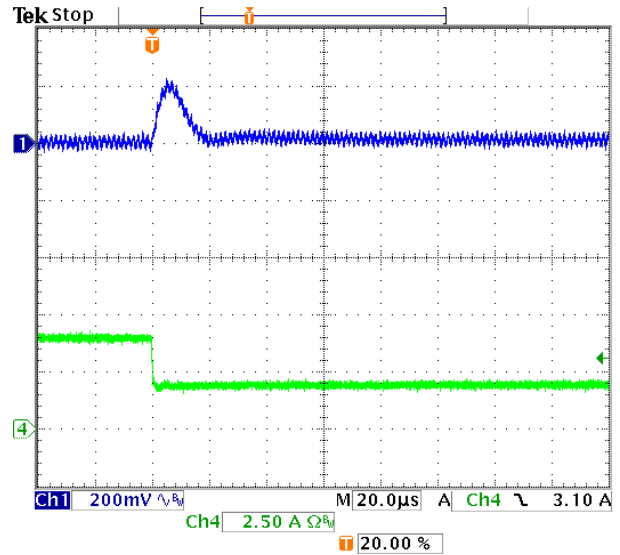

Fig. 12: Output voltage response for $V_{out}=8V$ to negative load current step change from 4A to 2A with slew rate of $-5A/\mu s$ at $V_{in}=24V$. $C_o=22\mu F \times 2$ ceramic + $1\mu F$ ceramic.

Top trace: output voltage (200mV/div.)
 Bottom trace: load current (2A/div.)
 Time scale: 20us/div.

FPMR19S3R304PA

8.0-27.6Vdc Input, 4A, 3.0-15.5Vdc Output

Preliminary Data Sheet

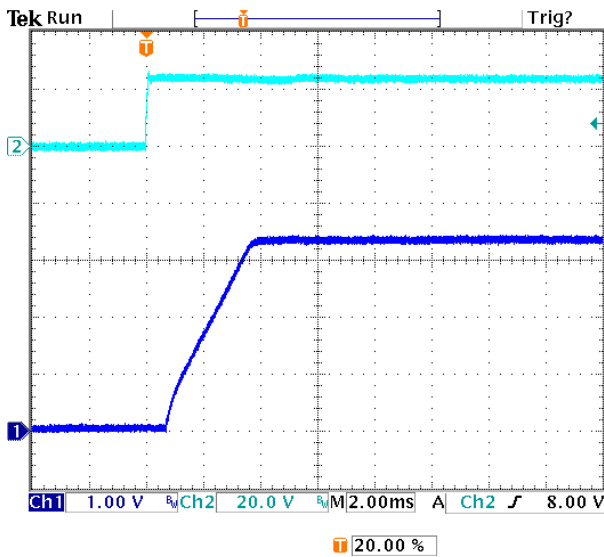

Fig. 13: Turn-on transient for $V_{out}=3.3V$ with application of V_{in} at full rated load current (resistive) and $22\mu F \times 2 + 1\mu F$ external capacitance at $V_{in}=24V$.

Top trace: V_{in} (20V/div.)
 Bottom trace: output voltage (1V/div.)
 Time scale: 2 ms/div.

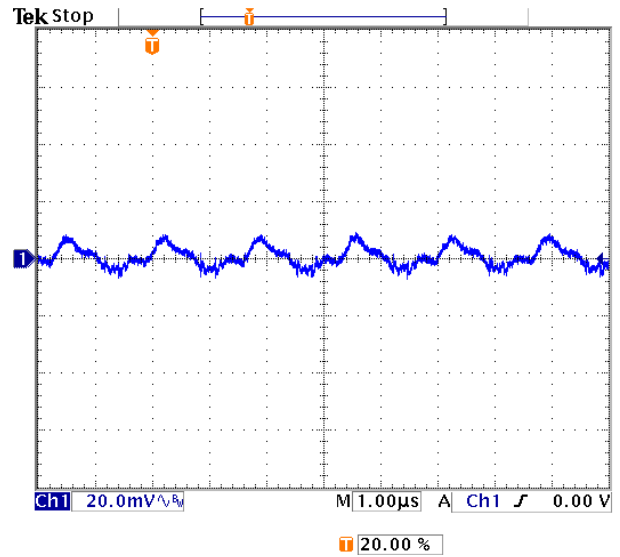

Fig. 14: Output voltage ripple (20mV/div.) for $V_{out}=3.3V$ at full rated load current into a resistive load with external capacitance $22\mu F \times 2$ ceramic + $1\mu F$ ceramic at $V_{in}=24V$.

Time scale: 1 us/div

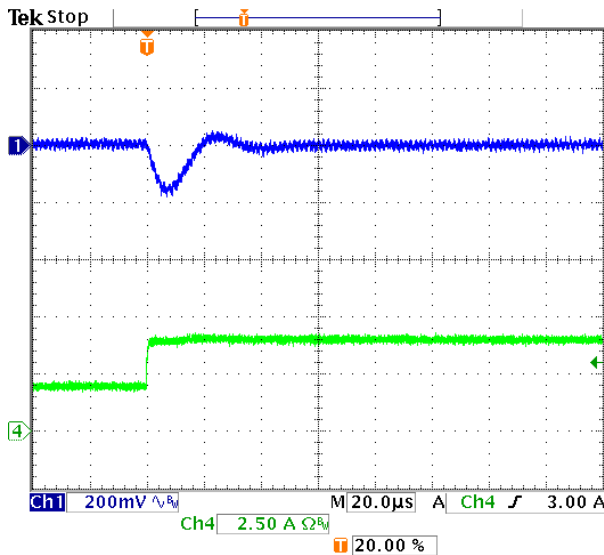

Fig. 15: Output voltage response for $V_{out}=3.3V$ to positive load current step change from 2A to 4A with slew rate of $5A/\mu s$ at $V_{in}=24V$. $C_o=22\mu F \times 2$ ceramic + $1\mu F$ ceramic.

Top trace: output voltage (200mV/div.)
 Bottom trace: load current (2A/div.)
 Time scale: 20us/div.

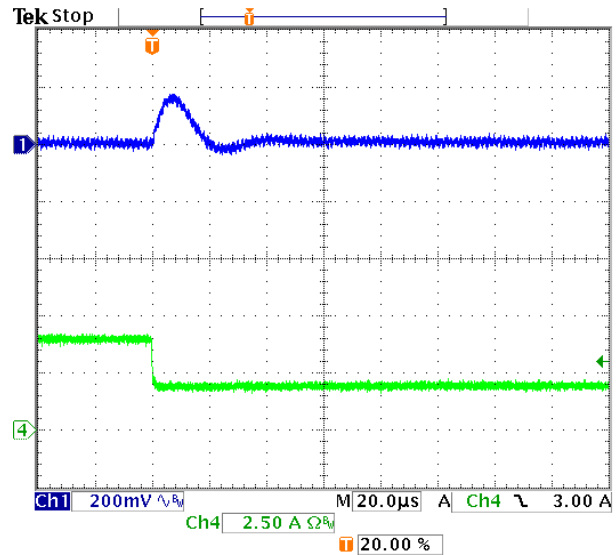

Fig. 16: Output voltage response for $V_{out}=3.3V$ to negative load current step change from 4A to 2A with slew rate of $-5A/\mu s$ at $V_{in}=24V$. $C_o=47\mu F \times 2$ ceramic + $1\mu F$ ceramic.

Top trace: output voltage (200mV/div.)
 Bottom trace: load current (2A/div.)
 Time scale: 20us/div.

FPMR19S3R304PA

Preliminary Data Sheet

8.0-27.6Vdc Input, 4A, 3.0-15.5Vdc Output

Mechanical Drawing

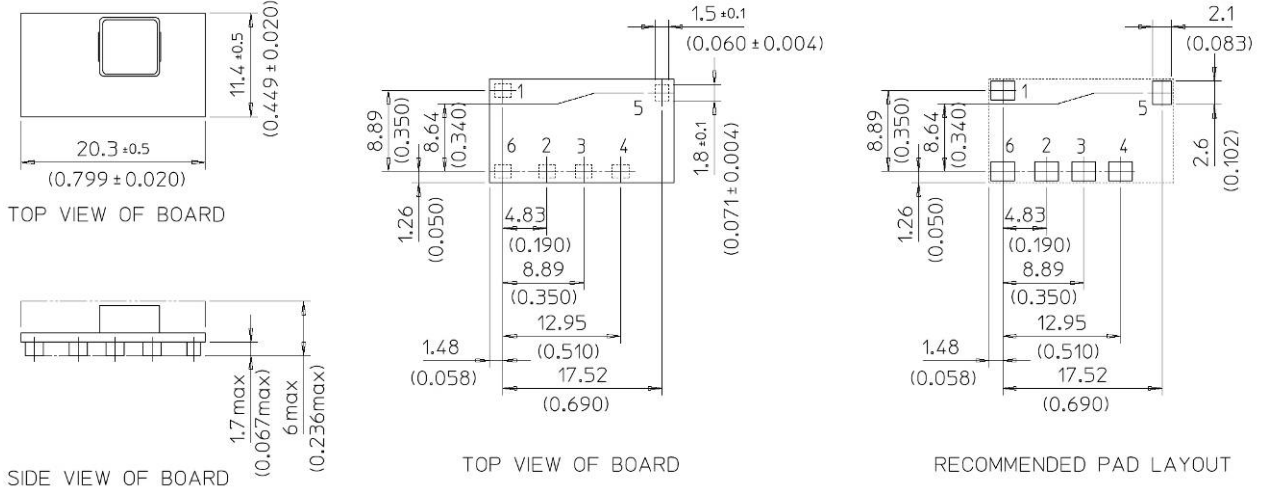

Notes

- All dimensions are in millimeters. (inches)
- Unless otherwise specified, tolerances are +/- 0.25mm
- Connector Material: Copper
- Connector Finish: Gold over Nickel
- Converter Weight: 0.08 oz (2.2 g)
- Converter Height: 6.0mm Max
- Recommended Surface-Mount Pads: 2.1mm x 2.6mm

Pin Connections	
Pin #	Function
1	Vin
2	GND
3	TRIM
4	Vout
5	ON/OFF
6	Power Good

Part Numbering Scheme

Product Series	Shape	Regulation	Input Voltage	Mounting Scheme	Output Voltage	Rated Current	ON/OFF Logic	Pin Shape
FP	M	R	19	S	3R3	04	P	A
Series Name	Middle	Regulated	Typ=19V	Surface Mount	3.3V (Programmable: See page 6)	4A	P: Positive	Standard

FPMR19S3R304PA

Preliminary Data Sheet

8.0-27.6Vdc Input, 4A, 3.0-15.5Vdc Output

Notes

PATTERN DESIGN: Please prohibit patterns other than 0V shield pattern the pattern drawing under the product considering the interference etc. of the insulation failure and another circuit.

パターン設計: 製品下面へのパターン引き回しは絶縁不良および他回路との干渉等を考慮して0Vシールドパターン以外のパターンは禁止してください。

NUCLEAR AND MEDICAL APPLICATIONS: FDK Corporation products are not authorized for use as critical components in life support systems, equipment used in hazardous environments, or nuclear control systems without the written consent of FDK Corporation.

核および医療のアプリケーション: FDK製品は生命維持装置、危険な環境に使用される設備、または核制御システムなどにおける重要部品としては、FDKの承諾書なしでの使用は認可されません。

Operating Conditions: Do not use converters under the following conditions because all these factors deteriorate the converter characteristics or cause failures. 1) Wet or humid locations, 2) corrosive or deoxidizing gas (Hydrogen sulfide, Sulfurous acid, Chloride and ammonia, etc), 3) Volatile or flammable gas, 4) Dusty conditions, 5) Under high pressure or low pressure, 6) location with salt water, oils, chemical liquids or organic solvents, or 7) Strong vibrations or mechanical impact.

使用環境: 本コンバータを以下に示す環境でご使用にならないでください。これらはコンバータの特性を劣化させ、最悪の場合、故障の原因となります。1) 水がかかる場所や多湿のために結露するおそれのある場所、2) 腐食性、還元性ガス(硫化水素、亜硫酸、塩素、アンモニア等) 雰囲気中、3) 揮発性、引火性のあるガス雰囲気、4) 粉塵の多い場所、5) 減圧、または加圧された空気中、6) 塩水、油、薬液、有機溶剤にさらされる場所、又は 7) 過酷な振動、又は衝撃が加わる場所

HIGH RELIABILITY AND LONG LIFE APPLICATIONS: If FDK Corporation products are used in high reliability or long life applications, reduce temperature of the converters and determine the condition on your own responsibility after confirming reliability and life time in your actual application.

高信頼性、及び長寿命が要求される装置での使用: 本コンバータを高信頼性、又は長寿命が要求される装置で使用する場合には、本コンバータの温度低減をするとともに、貴社様の責任において実装置上での信頼性と寿命を確認して使用条件を決定してください。

CLEANSING : Cleansing of this converter is not recommended. When cleansing, determine a cleansing condition on your own responsibility after confirming there is no impact on the characteristics/performance of the converter.

洗浄: 本コンバータの洗浄は推奨いたしません。洗浄する場合の洗浄条件は、貴社様責任において本コンバータの特性/性能に影響が無い事を確認して決定してください。

SPECIFICATION CHANGES AND REVISIONS: Specifications are revision-controlled, but are subject to change without notice.

仕様の変更と版数: 仕様は版数によって管理されていますが、予告なしで変更する場合がございます。

Storage Condition:

	Sealed bag	Opened *
Storage Temperature	Less than 40 degC	Less than 30 degC
Storage Humidity	Less than 90%RH Non Condensing	Less than 60%RH Non Condensing
Storage Life	12 months	12 months

* MSL rating of this product is 2 (IPC/JEDEC J-STD-033)

保管条件:

	未開封時	開封後 *
保存温度	40°C以下	30°C以下
保存湿度	90%RH以下 (結露なきこと)	60%RH以下 (結露なきこと)
保存期限	12ヶ月以内 (密封後)	12ヶ月以内

* 本製品のMSLレーティングはレベル2です (IPC/JEDEC J-STD-033)