

NHD-10.1-1024600AF-LSXV#

TFT (Thin-Film-Transistor) Color Liquid Crystal Display Module

NHD-	Newhaven Display
10.1-	10.1" Diagonal
1024600-	1024xRGBx600 Pixels
AF-	Model
L-	LVDS Interface
S-	High Brightness, White LED Backlight
X-	TFT
V-	MVA, Standard Temperature
#-	RoHS Compliant

Newhaven Display International, Inc.

2661 Galvin Ct.

Elgin IL, 60124

Ph: 847-844-8795

Fax: 847-844-8796

www.newhavendisplay.com

nhtech@newhavendisplay.com

nhsales@newhavendisplay.com

Document Revision History

Revision	Date	Description	Changed by
0	5/17/17	Initial Release	SB
1	8/14/17	Backlight Characteristics Added, Pin Descriptions Updated	SB
2	3/6/18	Electrical & Optical Characteristics Updated	SB
3	7/1/18	Backlight Redesign	SB
4	7/10/19	Electrical Characteristics Updated	SB
5	7/21/20	Updated 2D Mechanical Drawing; Kapton Tape on Golden Fingers	AS
6	8/18/20	Revision of SCL & SDA Pin Description; Included Horizontal & Vertical Timing Charts	AS

Functions and Features

- 1024xRGBx600 Resolution
- LED Backlight
 - Built In-LED Driver
 - PWM Brightness Control
- LVDS Interface
 - 4 LVDS Channels
- 262K Colors
- Wide Viewing Angles

Mechanical Drawing

SYMBOL	REVISION	DATE

Pin Assignment

PIN No.	SYMBOL
1	GND
2	VDD
3	VDD
4	V_EDID
5	GND
6	SCL
7	SDA
8	Rin0-
9	Rin0+
10	GND
11	Rin1-
12	Rin1+
13	GND
14	Rin2-
15	Rin2+
16	GND
17	CLKIN-
18	CLKIN+
19	GND
20	Rin3-
21	Rin3+
22	GND
23	INSEL
24	GND
25	GND
26	UPDN
27	SHLR
28	GND
29	RESET
30	STBYB
31	LED-GND
32	LED-GND
33	LED-GND
34	GND
35	LED_PWM
36	LED_EN
37	BIST
38	LED_VDD
39	LED_VDD
40	LED_VDD

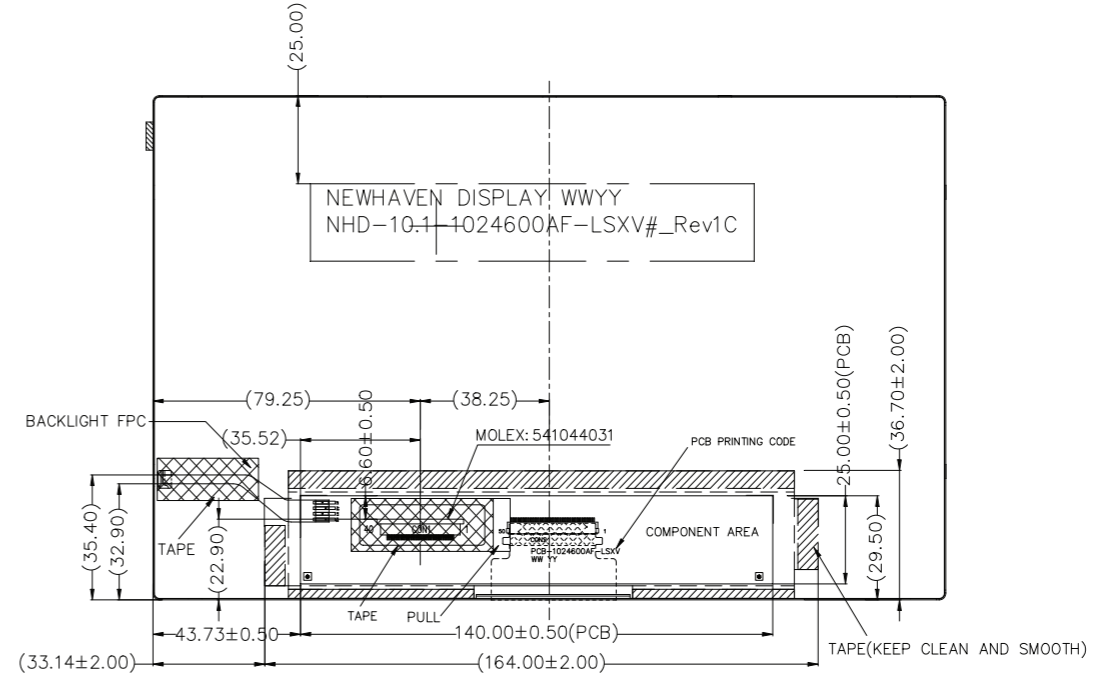
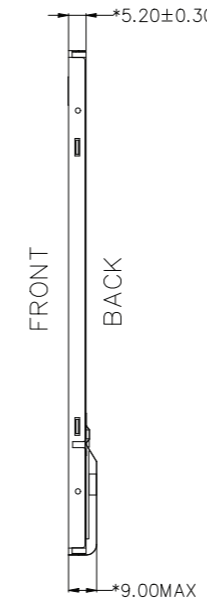
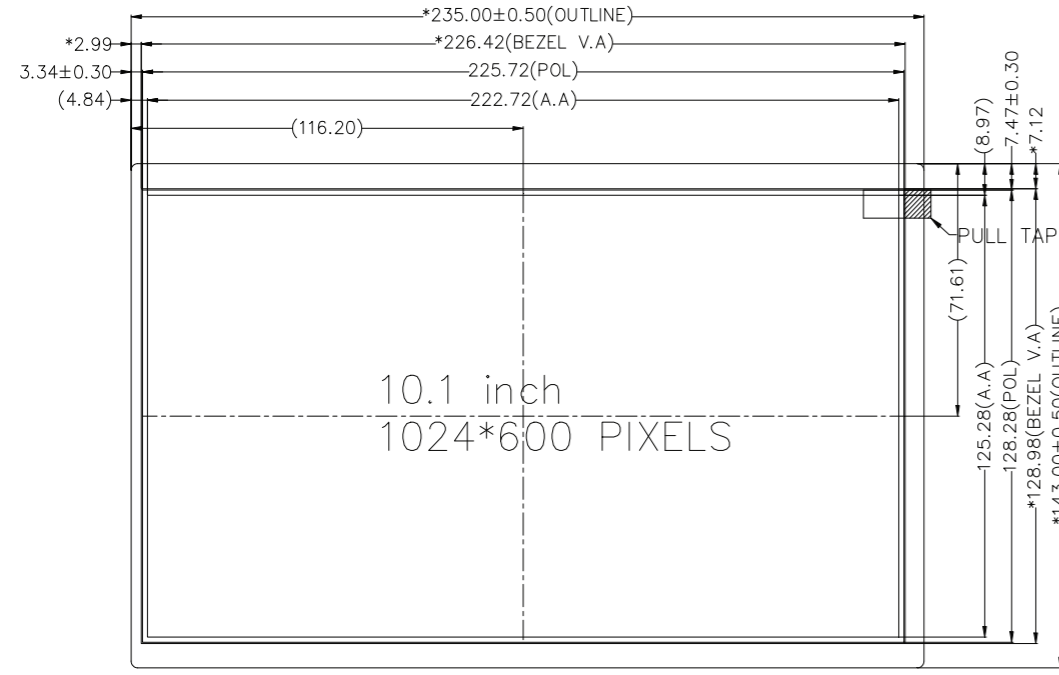

- Notes:
- | | |
|--------------------------|--|
| 1. Display Size: | 10.1" TFT |
| 2. Display Resolution: | 1024 x 600 Pixels |
| 3. Display Mode: | Transmissive / Normally White / Anti-Glare |
| 4. Optimal View: | Full View |
| 5. Driver IC: | HX8282 - LVDS Interface |
| 6. Power Supply Voltage: | 3.3V |
| 7. Backlight: | White LED |
| 8. Luminance: | 800cd/m ² (Typ) |

Backlight Circuit

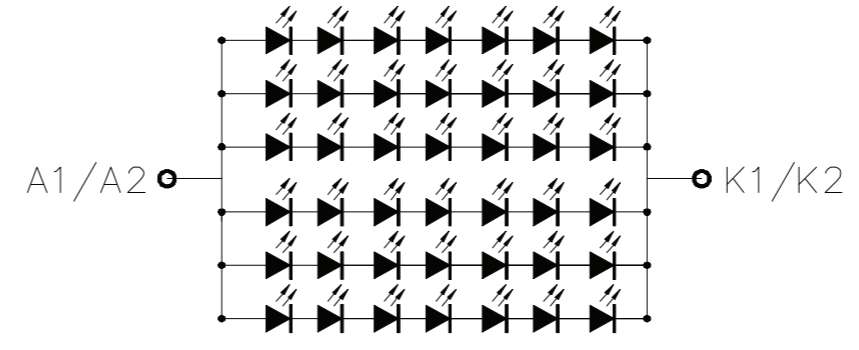

STANDARD TOLERANCE: (UNLESS OTHERWISE SPECIFIED)			
LINEAR: ±0.3mm		DRAWING/PART NUMBER: NHD-10.1-1024600AF-LSXV#	
UNLESS OTHERWISE SPECIFIED: - DIMENSIONS ARE IN MILLIMETERS - THIRD ANGLE PROJECTION		DRAWN BY: A. Shah	APPROVED BY: A. Shah
		DRAWN DATE: 7/21/20	APPROVED DATE: 7/21/20
		DO NOT SCALE DRAWING	
		SHEET 1 OF 1	
THIS DRAWING IS SOLELY THE PROPERTY OF NEWHAVEN DISPLAY INTERNATIONAL, INC. THE INFORMATION IT CONTAINS IS NOT TO BE DISCLOSED, REPRODUCED OR COPIED IN WHOLE OR PART WITHOUT WRITTEN APPROVAL FROM NEWHAVEN DISPLAY.			

Pin Description

Pin No.	Symbol	Connection	Function Description
1	GND	Power Supply	Ground
2-3	V _{DD}	Power Supply	Supply voltage for LCD (+3.3V)
4	V _{EDID}	Power Supply	Supply voltage for EDID (+3.3V)
5	GND	Power Supply	Ground
6	SCL	MPU	Serial Clock for EDID
7	SDA	MPU	Serial Data for EDID
8	Rin0-	MPU	-LVDS differential data input CH0
9	Rin0+	MPU	+LVDS differential data input CH0
10	GND	Power Supply	Ground
11	Rin1-	MPU	-LVDS differential data input CH1
12	Rin1+	MPU	+LVDS differential data input CH1
13	GND	Power Supply	Ground
14	Rin2-	MPU	-LVDS differential data input CH2
15	Rin2+	MPU	+LVDS differential data input CH2
16	GND	Power Supply	Ground
17	CLKIN-	MPU	-LVDS differential Clock
18	CLKIN+	MPU	+LVDS differential Clock
19	GND	Power Supply	Ground
20	Rin3-	MPU	-LVDS differential data input CH3
21	Rin3+	MPU	+LVDS differential data input CH3
22	GND	Power Supply	Ground
23	INSEL (HSD)	MPU	Data Input Format: INSEL = L 8-Bit LVDS Input (Default) INSEL = H 6-Bit LVDS Input
24-25	GND	Power Supply	Ground
26	UPDN	MPU	Gate Driver Up/Down Scan Setting: UPDN = H: Reverse Scan UPDN = L: Normal Scan (Default)
27	SHLR	MPU	Gate Driver Left/Right Scan Setting: SHLR = H: Normal Scan (Default) SHLR = L: Reverse Scan
28	GND	Power Supply	Ground
29	RESET	MPU	Active Low Reset Signal
30	STBYB	MPU	Active Low Standby Signal
31-33	LED_GND	Power Supply	Ground for Backlight Driver
34	GND	Power Supply	Ground
35	LED_PWM	MPU	Backlight PWM Signal Input (See Table Below)
36	LED_EN	MPU	Backlight Enable H: Backlight On; L: Backlight Off
37	BIST	MPU	Built in Self-Test BIST = H: Self-Test Enabled BIST = L: Normal Operation (Default)
38-40	LED_V _{DD}	Power Supply	Supply Voltage for Backlight Driver

LCD connector: 0.5mm pitch 40-Conductor FFC.

Recommended cable: 40 POS FFC **Molex P/N:** 15020-0435

LED_PWM Signal Operating Frequency:

PWM Frequency (F)	Duty Cycle (Min.)	Duty Cycle (Max.)
100Hz < F < 500Hz	5%	100%
500Hz < F < 20KHz	10%	100%

Electrical Characteristics (T_{OP} = 25°C)

Item	Symbol	Condition	Min.	Typ.	Max.	Unit
Operating Temperature Range	T _{OP}	Absolute Max	0	-	+50	°C
Storage Temperature Range	T _{ST}	Absolute Max	-20	-	+60	°C
Supply Voltage for LCD	V _{DD}	-	3.0	3.3	3.6	V
Supply Voltage for EDID	V _{EDID}	-	3.0	3.3	3.6	V
Supply Current for LCD	I _{DD}	V _{DD} = 3.3V	50	120	180	mA
LVDS Differential input HIGH Voltage	RxVTH	-	-	-	+100	mV
LVDS Differential input LOW Voltage	RxVTL	-	-100	-	-	mV
LVDS Differential input Common Voltage	RxVCM	-	0.7	-	1.6	V
LVDS Differential Voltage	VID	-	200	-	600	mV
Supply Voltage for Backlight Driver	LED_V _{DD}	-	5.0	12.0	22.4	V
Supply Current for Backlight Driver ¹	LED_I _{DD}	-	160	360	1200	mA
Backlight Enable Voltage	LED_EN	-	2.5	3.3	5.5	V
Backlight PWM Voltage	LED_PWM	I _{PWM} ≤ 5 mA	2.5	3.3	5.5	V
Backlight Lifetime ₂	-	T _{OP} = 25° C	20,000	50,000	-	Hrs.

¹Minimum supply current occurs when supply voltage is at max; maximum supply current when supply voltage is at minimum.

²Backlight lifetime is rated as Hours until **half-brightness**, under normal operating conditions.

Optical Characteristics

Item	Symbol	Condition	Min.	Typ.	Max.	Unit	
Optimal Viewing Angles	Top	Cr ≥ 10	-	80	-	°	
	Bottom		-	80	-	°	
	Left		-	80	-	°	
	Right		-	80	-	°	
Contrast Ratio	CR	-	450	750	-	-	
Luminance	L _V	-	600	800	1000	cd/m ²	
Response Time	Rise + Fall	T _R + T _F	T _{OP} = 25°C		-	8	ms
Chromaticity	Red	X _R	-	0.565	0.605	0.635	-
		Y _R	-	0.309	0.349	0.379	-
	Green	X _G	-	0.286	0.326	0.356	-
		Y _G	-	0.565	0.605	0.635	-
	Blue	X _B	-	0.112	0.152	0.182	-
		Y _B	-	0.075	0.115	0.145	-
White	X _W	-	0.257	0.297	0.327	-	
	Y _W	-	0.283	0.323	0.353	-	

Driver Information

Built-in HX8282 Source Driver: <http://www.newhavendisplay.com/appnotes/datasheets/LCDs/HX8282-A01.pdf>

Built-in HX8696 Gate Driver: <http://www.newhavendisplay.com/appnotes/datasheets/LCDs/HX8696-A.pdf>

Timing Characteristics

Parameter	Symbol	Spec			Unit	Condition
		Min.	Typ.	Max.		
Clock frequency	R _{XFCLK}	20	-	71	MHz	-
Input data skew margin	T _{RSKM}	500	-	-	pS	VID = 400mV R _{XVCM} = 1.2V R _{XFCLK} = 71MHz
Clock high time	T _{LVCH}	-	4/(7 * R _{XFCLK})	-	nS	-
Clock low time	T _{LVCL}	-	3/(7 * R _{XFCLK})	-	nS	-
PLL wake-up time	T _{emPLL}	-	-	150	μS	-

Parameter	Symbol	Spec			Unit	Condition
		Min.	Typ.	Max.		
Modulation Frequency	SSC _{MF}	23	-	93	KHz	-
Modulation Rate	SSC _{MR}	-	-	±3	%	LVDS Clock = 71 MHz

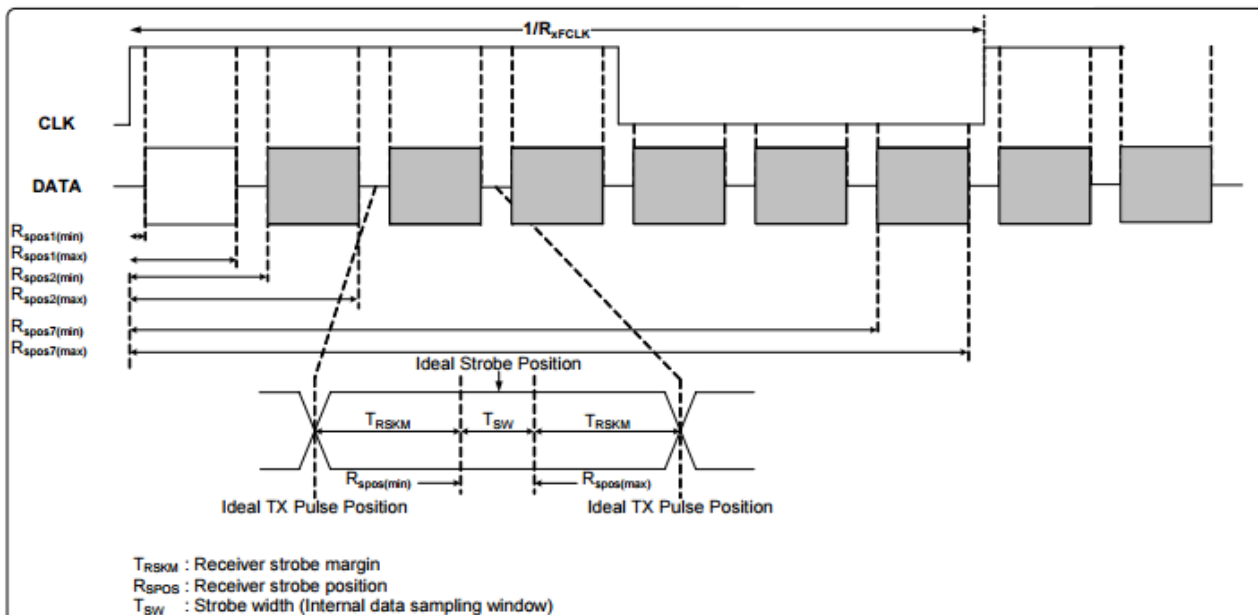
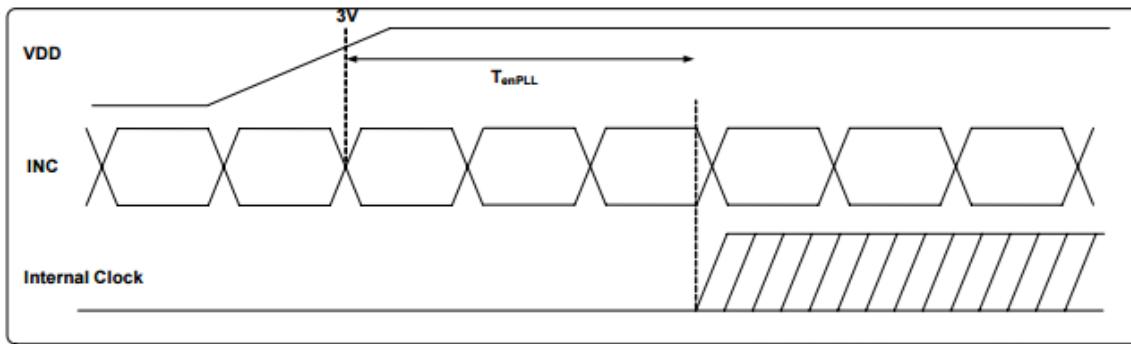
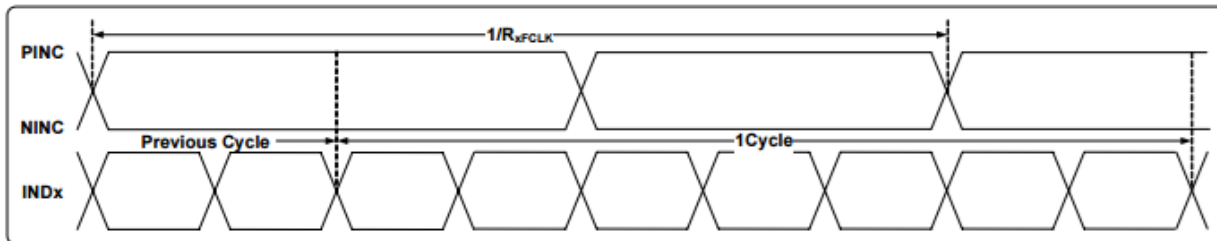

6-bit LVDS data input format:

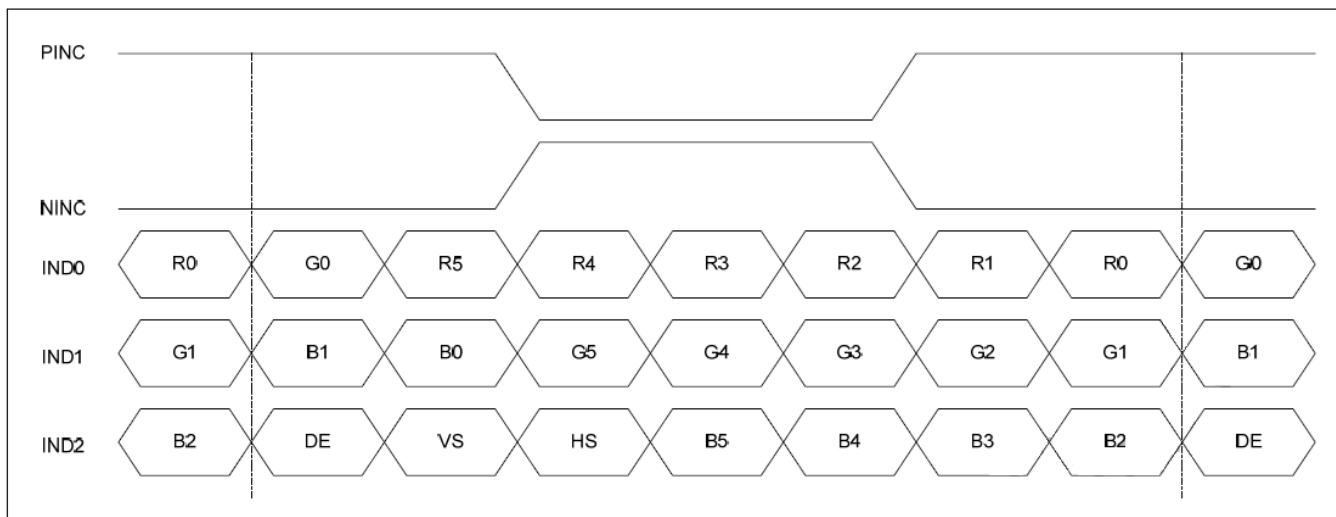

8-Bit LVDS Data Input Format:

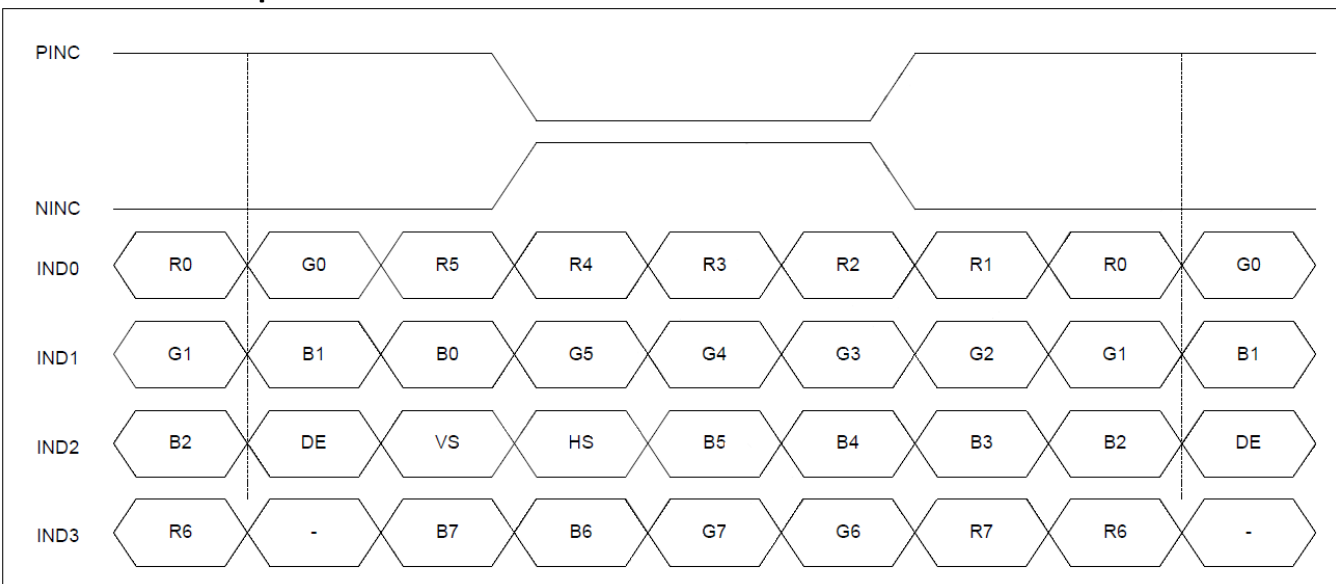

Horizontal & Vertical Timing (1024x600)

Item	Symbol	Spec.			Unit	
		Min.	Typ.	Max.		
DCLK Frequency	F _{CLK}	44.9	51.2	63	MHz	
HSYNC	Horizontal Display Area	1024			DCLK	
	HSD Period	T _H	1200	1344	1400	DCLK
	HSD Pulse Width	T _{HPW}	1	-	140	DCLK
	HSD Back Porch	T _{HBP}	160			DCLK
	HSD Front Porch	T _{HFP}	16	160	216	DCLK
VSYNC	Vertical Display Area	T _{VD}	600			T _H
	VSD Period	T _V	624	635	750	T _H
	VSD Pulse Width	T _{VPW}	1	-	20	T _H
	VSD Back Porch	T _{VBP}	23			T _H
	VSD Front Porch	T _{VFP}	1	12	127	T _H

Backlight Power ON Timing Sequence

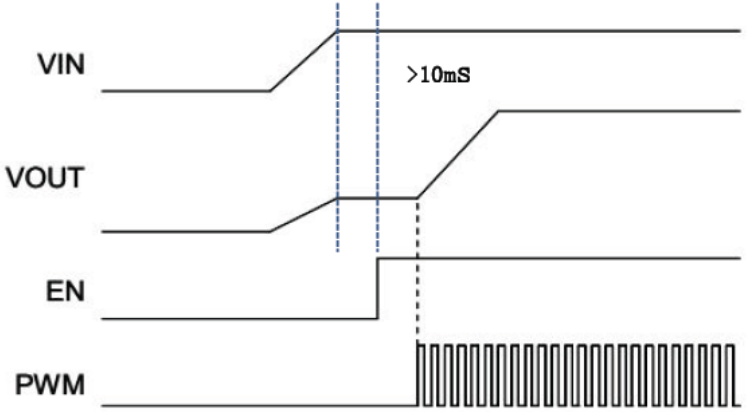

Quality Information

Test Item	Content of Test	Test Condition	Note
High Temperature storage	Endurance test applying the high storage temperature for a long time.	+60°C, 240 hrs.	2
Low Temperature storage	Endurance test applying the low storage temperature for a long time.	-20°C, 240 hrs.	1,2
High Temperature Operation	Endurance test applying the electric stress (voltage & current) and the high thermal stress for a long time.	+50°C, 120 hrs.	2
Low Temperature Operation	Endurance test applying the electric stress (voltage & current) and the low thermal stress for a long time.	0°C, 120 hrs.	1,2
High Temperature / Humidity Operation	Endurance test applying the electric stress (voltage & current) and the high thermal with high humidity stress for a long time.	+50°C, 90% RH, 120 hrs.	1,2
Thermal Shock resistance	Endurance test applying the electric stress (voltage & current) during a cycle of low and high thermal stress.	0°C, 30min->25°C, 5min -> 50°C, 30min 10 cycles	
Vibration test	Endurance test applying vibration to simulate transportation and use.	10-55Hz, 1.5mm amplitude. 60 sec in each of 3 directions X, Y, Z For 15 minutes	3
Static electricity test	Endurance test applying electric static discharge.	Air: V _s =8KV, Contact: V _s =4KV 10 Times	

Note 1: No condensation to be observed.

Note 2: Conducted after 4 hours of storage at 25°C, 0%RH.

Note 3: Test performed on product itself, not inside a container.

Precautions for using LCDs/LCMs

See Precautions at www.newhavendisplay.com/specs/precautions.pdf

Warranty Information and Terms & Conditions

http://www.newhavendisplay.com/index.php?main_page=terms