

RF3631D

**427.5 MHz
SAW Filter**

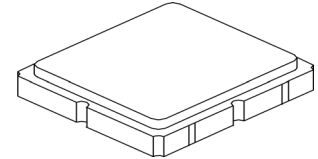

SM3838-6 Case

- **Advanced LiTaO₃ Design for Low Insertion Loss**
- **Hermetically-sealed Surface Mount package**
- **Complies with Directive 2002/95/EC (RoHS)**
- **Moisture Sensitivity Level: 1**

Absolute Maximum Ratings

Rating	Value	Units
Maximum Input Power	+10	dBm
DC Voltage between Terminals	3	VDC
Operable Temperature Range	-40 to +125	°C
Specification Temperature Range	-40 to +85	°C
Storage Temperature Range	-40 to +85	°C

Characteristic	Sym	Notes	Minimum	Typical	Maximum	Units
Center Frequency	f_c			427.5		MHz
1.0 dB Bandwidth				19.5		dB
3.0 dB Bandwidth				23.6		
Insertion Loss 420 to 435 MHz	IL			1.5	3.0	
Attenuation (reference from 0 dB):						dB
10 to 360 MHz			50	56		
360 to 400 MHz			47	53		
487 to 600 MHz			47	51		
600 to 1000 MHz			43	48		
Source Impedance				50		Ω
Load Impedance				50		
Case			SM3838-6, 3.8 x 3.8 mm Footprint			
Lid Symbolization (YY=Year, WW=week, S=shift)			B55, <u>YWWS</u>			

Electrical Connections

Connection	Terminals
RF Input	2
RFOutput	5
Case Ground	All Others

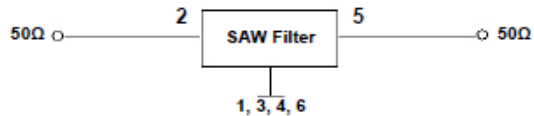

CAUTION: Electrostatic Sensitive Device. Observe precautions for handling.

NOTES:

1. The design, manufacturing process, and specifications of this device are subject to change.
2. US or International patents may apply.
3. RoHS compliant from the first date of manufacture.

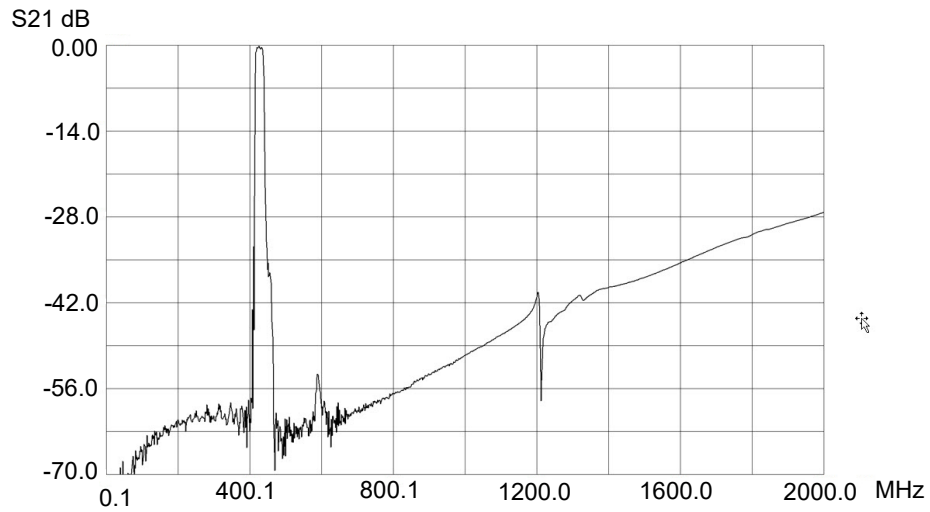
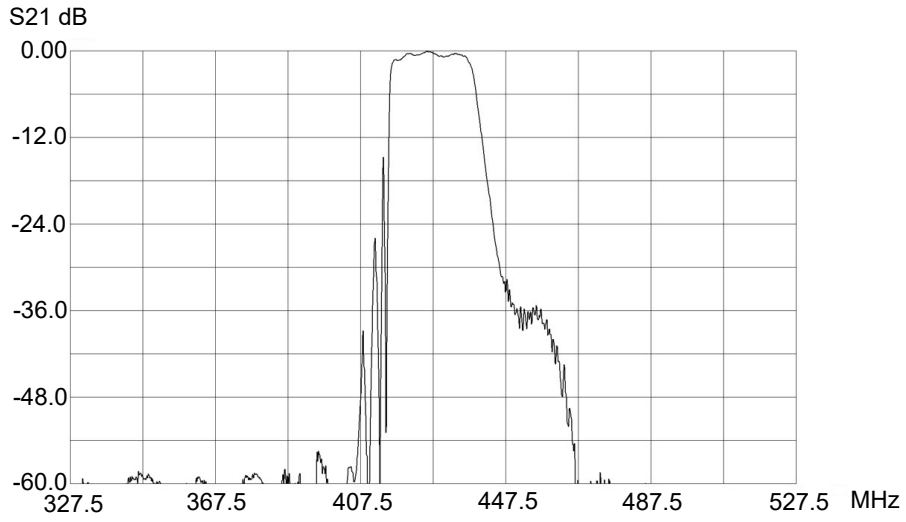
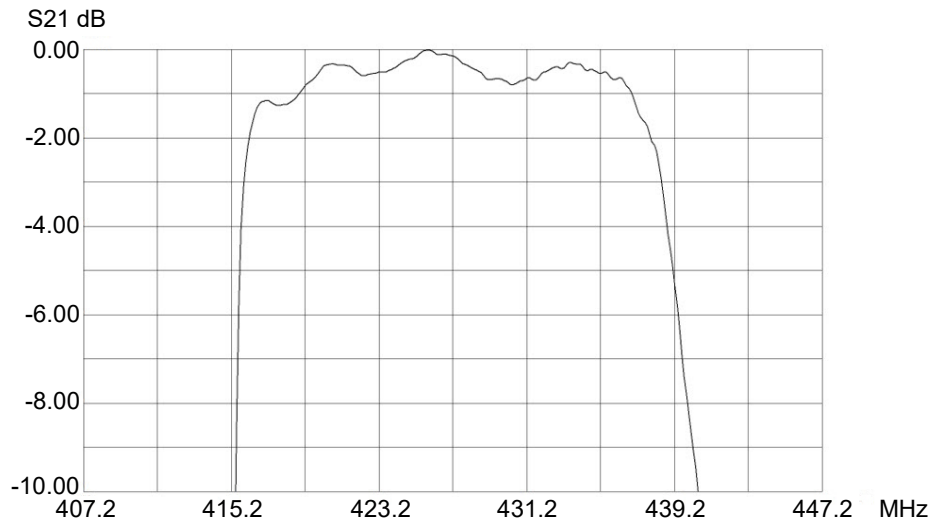

SM3838-6 Case

6-Terminal Ceramic Surface-Mount Case 3.8 X 3.8 mm Nominal Footprint

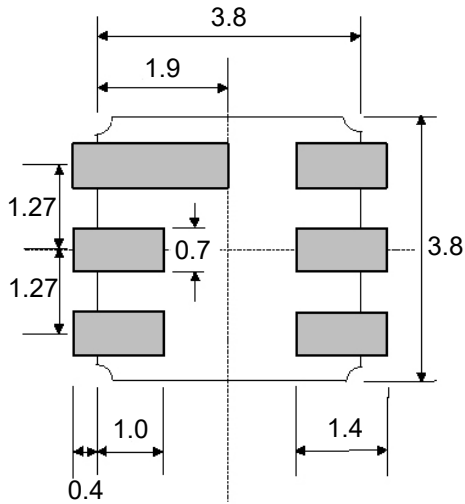
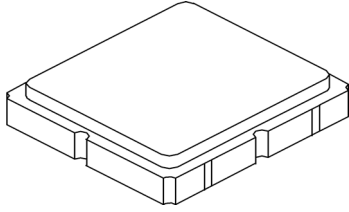

PCB Footprint

Case Dimensions

Dimension	mm			Inches		
	Min	Nom	Max	Min	Nom	Max
A	3.60	3.80	4.00	0.142	0.150	0.157
B	3.60	3.80	4.00	0.142	0.150	0.157
C	1.10	1.30	1.50	0.043	0.050	0.060
D	0.95	1.10	1.25	0.037	0.043	0.049
E	2.39	2.54	2.69	0.094	0.100	0.106
G	0.90	1.00	1.10	0.035	0.040	0.043
H	1.90	2.00	2.10	0.748	0.079	0.083
I	0.50	0.60	0.70	0.020	0.024	0.028
J	1.70	1.80	1.90	0.067	0.071	0.075
K	-	-	1.43	-	-	0.056

Case Material

Materials	
Solder Pad Plating	0.3 to 1.0 μm Gold over 1.27 to 8.89 μm Nickel
Lid Plating	2.0 to 3.0 μm Nickel
Body	Al_2O_3 Ceramic

TOP VIEW

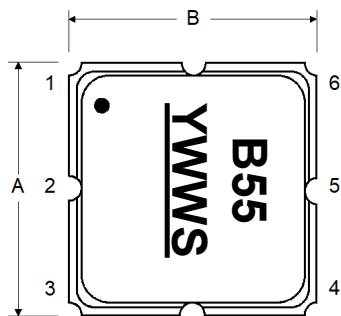

BOTTOM VIEW

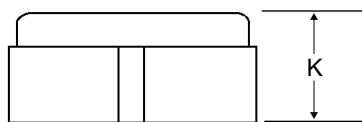
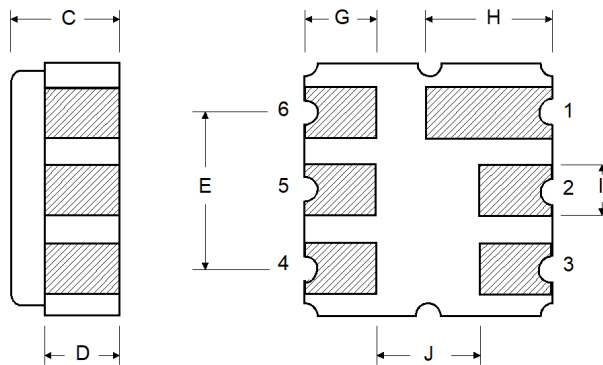

Tape and Reel Specifications

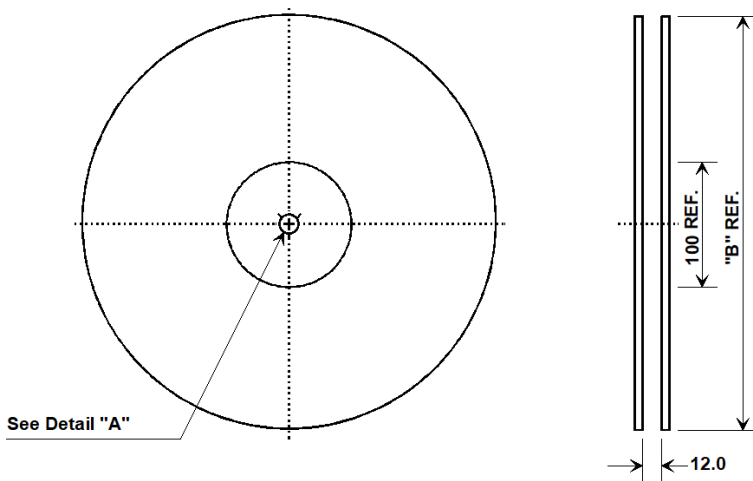

Tape and Reel Standard per ANSI/EIA-481

"B" Nominal Size		Quantity Per Reel
Inches	millimeters	
7	178	500
13	330	3000

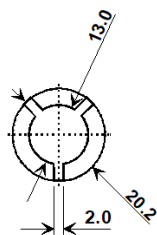

COMPONENT ORIENTATION and DIMENSIONS

Carrier Tape Dimensions	
Ao	4.25 mm
Bo	4.25 mm
Ko	1.30 mm
Pitch	8.0 mm
W	12.0 mm

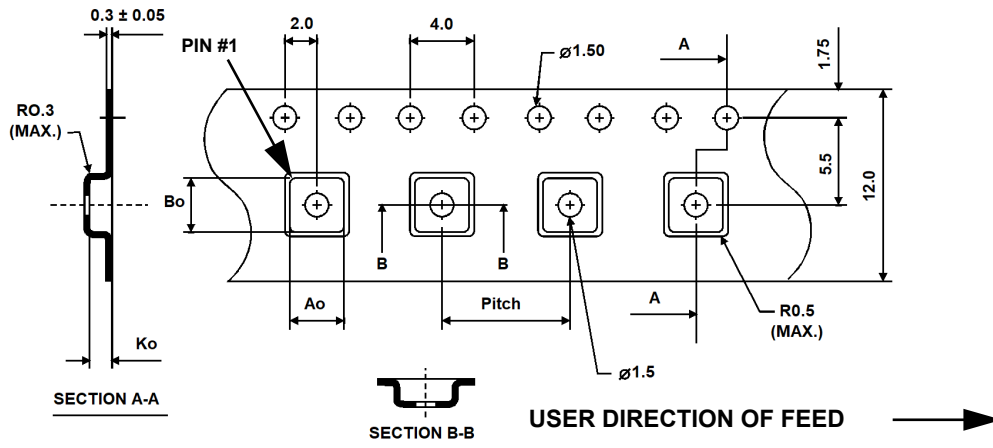

Recommended Reflow Profile

1. Preheating shall be fixed at 150~180°C for 60~90 seconds.
2. Ascending time to preheating temperature 150°C shall be 30 seconds min.
3. Heating shall be fixed at 220°C for 50~80 seconds and at 260°C +0/-5°C peak (10 seconds).
4. Time: 5 times maximum.

