

1 W SP3T SWITCH

DESCRIPTION

The μ PG2405T6Q is an SP3T GaAs FET switch which was developed for Bluetooth™, wireless LAN and NFC.

<R> This device can operate frequency from 10 MHz to 2.5 GHz, having the low insertion loss and high linearity.

This device is housed in a 10-pin plastic TSSON (Thin Shrink Small Out-line Non-leaded) package. And this package is able to high-density surface mounting.

FEATURES

- Low insertion loss : $L_{ins} = 0.45$ dB TYP. @ $f = 1.0$ GHz, $V_{cont}(H) = 2.8$ V, $V_{cont}(L) = 0$ V
 : $L_{ins} = 0.55$ dB TYP. @ $f = 2.0$ GHz, $V_{cont}(H) = 2.8$ V, $V_{cont}(L) = 0$ V
 : $L_{ins} = 0.60$ dB TYP. @ $f = 2.5$ GHz, $V_{cont}(H) = 2.8$ V, $V_{cont}(L) = 0$ V
- High isolation : $ISL = 28$ dB TYP. @ $f = 1.0$ GHz, $V_{cont}(H) = 2.8$ V, $V_{cont}(L) = 0$ V
 : $ISL = 22$ dB TYP. @ $f = 2.0$ GHz, $V_{cont}(H) = 2.8$ V, $V_{cont}(L) = 0$ V
 : $ISL = 20$ dB TYP. @ $f = 2.5$ GHz, $V_{cont}(H) = 2.8$ V, $V_{cont}(L) = 0$ V
- Handling power : $P_{in(0.1\text{ dB})} = +31.0$ dBm TYP. @ $f = 2.5$ GHz, $V_{cont}(H) = 2.8$ V, $V_{cont}(L) = 0$ V
- High-density surface mounting : 10-pin plastic TSSON package (2.0 × 1.35 × 0.37 mm)

APPLICATIONS

- Bluetooth and IEEE802.11b/g etc.
- NFC (FeliCa™ etc.)

ORDERING INFORMATION

Part Number	Order Number	Package	Marking	Supplying Form
μ PG2405T6Q-E2	μ PG2405T6Q-E2-A	10-pin plastic TSSON (Pb-Free)	G5M	<ul style="list-style-type: none"> • Embossed tape 8 mm wide • Pin 5, 6 face the perforation side of the tape • Qty 3 kpcs/reel

Remark To order evaluation samples, please contact your nearby sales office.

Part number for sample order: μ PG2405T6Q-A

Caution Although this device is designed to be as robust as possible, ESD (Electrostatic Discharge) can damage this device. This device must be protected at all times from ESD. Static charges may easily produce potentials of several kilovolts on the human body or equipment, which can discharge without detection. Industry-standard ESD precautions must be employed at all times.

The information in this document is subject to change without notice. Before using this document, please confirm that this is the latest version.

PIN CONNECTIONS AND INTERNAL BLOCK DIAGRAM

(Top View)

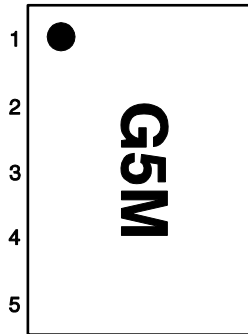

(Top View)

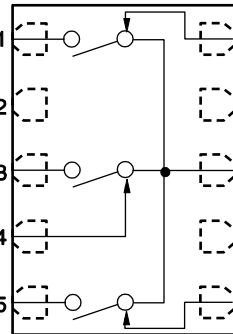

(Bottom View)

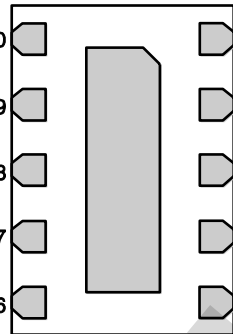

Pin No.	Pin Name
1	RF1
2	GND
3	RF2
4	V _{cont2}
5	RF3
6	V _{cont3}
7	GND
8	ANT
9	GND
10	V _{cont1}

Remark Exposed pad : GND

TRUTH TABLE

V _{cont1}	V _{cont2}	V _{cont3}	ANT-RF1	ANT-RF2	ANT-RF3
High	Low	Low	ON	OFF	OFF
Low	High	Low	OFF	ON	OFF
Low	Low	High	OFF	OFF	ON

ABSOLUTE MAXIMUM RATINGS (T_A = +25°C, unless otherwise specified)

Parameter	Symbol	Ratings	Unit
Switch Control Voltage	V _{cont}	+6.0 Note	V
Input Power	P _{in}	+34	dBm
Operating Ambient Temperature	T _A	-45 to +85	°C
Storage Temperature	T _{stg}	-55 to +150	°C

Note |V_{cont(H)} - V_{cont(L)}| ≤ 6.0 V

RECOMMENDED OPERATING RANGE (TA = +25°C)

Parameter	Symbol	MIN.	TYP.	MAX.	Unit
Switch Control Voltage (H)	V _{cont (H)}	2.7	2.8	3.0	V
Switch Control Voltage (L)	V _{cont (L)}	-0.2	0	0.2	V
Control Voltage Difference (H)	ΔV _{cont (H)} Note1	-0.1	0	0.1	V
Control Voltage Difference (L)	ΔV _{cont (L)} Note2	-0.1	0	0.1	V

- Notes 1.** ΔV_{cont (H)} is a difference between the maximum and the minimum control voltages among V_{cont1 (H)}, V_{cont2 (H)} and V_{cont3 (H)}.
- 2.** ΔV_{cont (L)} is a difference between the maximum and the minimum control voltages among V_{cont1 (L)}, V_{cont2 (L)} and V_{cont3 (L)}.

ELECTRICAL CHARACTERISTICS

(TA = +25°C, V_{cont (H)} = 2.8 V, V_{cont (L)} = 0 V, Zo = 50 Ω, DC blocking capacitors = 56 pF, unless otherwise specified)

Parameter	Symbol	Pass	Test Conditions	MIN.	TYP.	MAX.	Unit
Insertion Loss	L _{ins}	ANT to RF1, 2, 3	f = 0.5 to 1.0 GHz	-	0.45	0.65	dB
			f = 1.0 to 2.0 GHz	-	0.55	0.80	dB
			f = 2.0 to 2.5 GHz	-	0.60	0.85	dB
Isolation	ISL	ANT to RF1, 2, 3 (OFF)	f = 0.5 to 1.0 GHz	24	28	-	dB
			f = 1.0 to 2.0 GHz	18	22	-	dB
			f = 2.0 to 2.5 GHz	16	20	-	dB
Input Return Loss	RL _{in}	ANT to RF1, 2, 3	f = 0.5 to 2.5 GHz	15	20	-	dB
Output Return Loss	RL _{out}	ANT to RF1, 2, 3	f = 0.5 to 2.5 GHz	15	20	-	dB
0.1 dB Loss Compression Input Power	P _{in (0.1 dB)}	ANT to RF1, 2, 3	f = 2.5 GHz	+29.0	+31.0	-	dBm
2nd Harmonics	2f ₀	ANT to RF1, 2, 3	f = 2.5 GHz, P _{in} = 23 dBm	65	75	-	dBc
3rd Harmonics	3f ₀	ANT to RF1, 2, 3	f = 2.5 GHz, P _{in} = 23 dBm	65	75	-	dBc
Switch Control Current	I _{cont}		RF None	-	0.2	50	μA
Switch Control Speed	t _{sw}			-	70	-	ns

Note P_{in (0.1 dB)} is measured the input power level when the insertion loss increases more 0.1 dB than that of linear range.

EVALUATION CIRCUIT

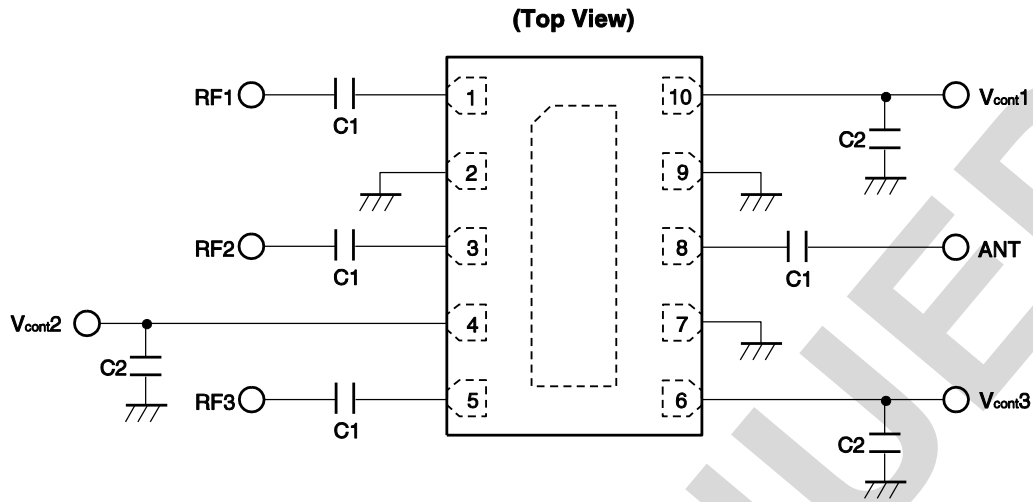

The application circuits and their parameters are for reference only and are not intended for use in actual design-ins.

USING THE EVALUATION BOARD

Symbol	Values
C1	56 pF
C2	1 000 pF

APPLICATION INFORMATION

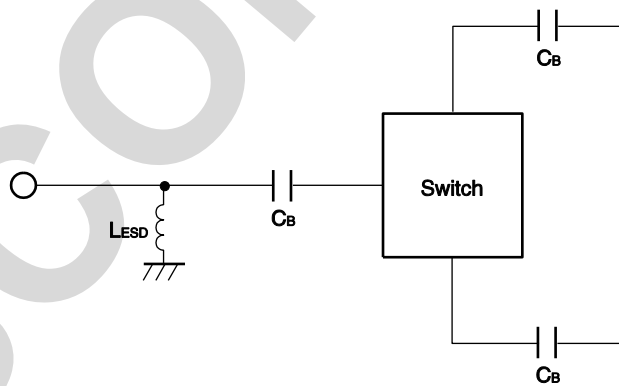

- C_B are DC blocking capacitors external to the device.
A value of 56 pF is sufficient for operation from 500 MHz to 2.5 GHz bands.
The value may be tailored to provide specific electrical responses.
- The RF ground connections should be kept as short as possible and connected to directly to a good RF ground for best performance.
- L_{ESD} provides a means to increase the ESD protection on a specific RF port, typically the port attached to the antenna.

MOUNTING PAD LAYOUT DIMENSIONS

10-PIN PLASTIC TSSOP (UNIT: mm)

MOUNTING PAD

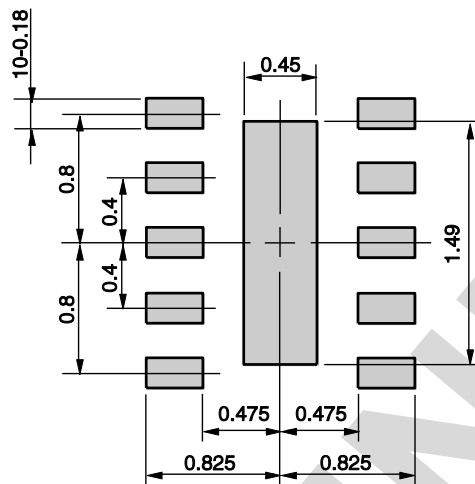

Remark The mounting pad layout in this document is for reference only.
 When designing PCB, please consider workability of mounting, solder joint reliability, prevention of solder bridge and so on, in order to optimize the design.

PACKAGE DIMENSIONS

10-PIN PLASTIC TSSOP (UNIT: mm)

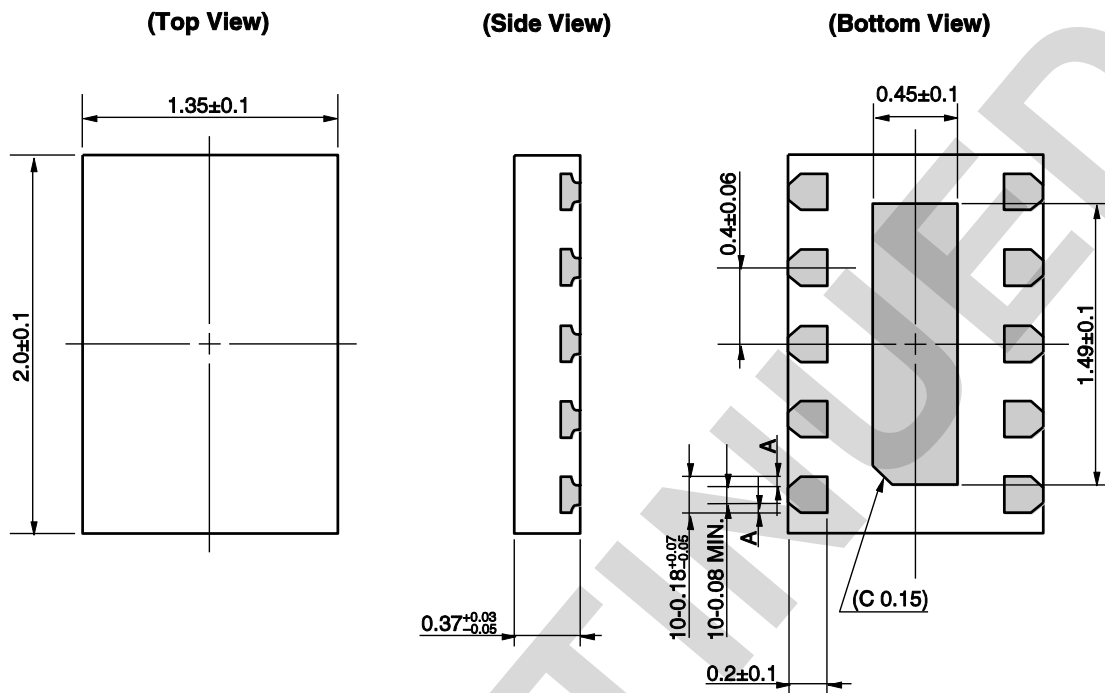

Remark A>0
 () : Reference value

DISCONTINUED

RECOMMENDED SOLDERING CONDITIONS

This product should be soldered and mounted under the following recommended conditions. For soldering methods and conditions other than those recommended below, contact your nearby sales office.

Soldering Method	Soldering Conditions	Condition Symbol
Infrared Reflow	Peak temperature (package surface temperature) : 260°C or below Time at peak temperature : 10 seconds or less Time at temperature of 220°C or higher : 60 seconds or less Preheating time at 120 to 180°C : 120±30 seconds Maximum number of reflow processes : 3 times Maximum chlorine content of rosin flux (% mass) : 0.2%(Wt.) or below	IR260
Partial Heating	Peak temperature (terminal temperature) : 350°C or below Soldering time (per side of device) : 3 seconds or less Maximum chlorine content of rosin flux (% mass) : 0.2%(Wt.) or below	HS350

Caution Do not use different soldering methods together (except for partial heating).

DISCONTINUED

<p>Caution</p>	<p>GaAs Products</p>	<p>This product uses gallium arsenide (GaAs). GaAs vapor and powder are hazardous to human health if inhaled or ingested, so please observe the following points.</p> <ul style="list-style-type: none"> • Follow related laws and ordinances when disposing of the product. If there are no applicable laws and/or ordinances, dispose of the product as recommended below. <ol style="list-style-type: none"> 1. Commission a disposal company able to (with a license to) collect, transport and dispose of materials that contain arsenic and other such industrial waste materials. 2. Exclude the product from general industrial waste and household garbage, and ensure that the product is controlled (as industrial waste subject to special control) up until final disposal. • Do not burn, destroy, cut, crush, or chemically dissolve the product. • Do not lick the product or in any way allow it to enter the mouth.
-----------------------	----------------------	---

DISCONTINUED