

ITEM NO.	PART NUMBER	DESCRIPTION	QTY.	COMPONENT NOTES
1	50-00993	Connector, 8 pin M12 X-code plug, 12xL38.6mm, gold plated, molding style, solder cup, IP67, shielded	1	
2	30-01713	Wire, 4PR BC, 24 AWG, CAT6a SF/UTP, UL20387, 300V, 105C, 60C oil, UV, 7.2 mm, shielded, VW-1, PVC	1	
3	24-00363	Overmold, M12 X-code plug and jack, 180°	1	PVC, black, 60 °C oil and UV resistant

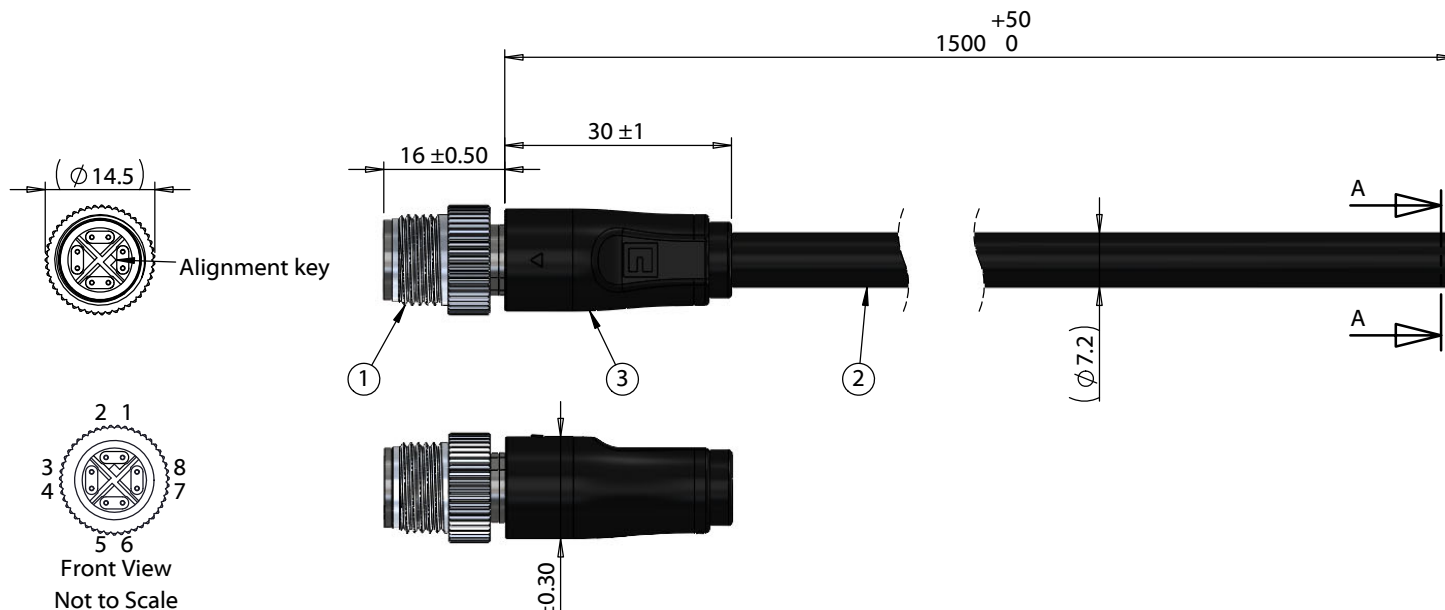

Notes:
 Cable rated for 48 V, 0.5 A
 Temperature: -40 ~ 105 °C

Wire:
 Oil resistant up to 60 °C
 Water resistant up to 75 °C
 UV resistant
 CAT6a rated

IP67 waterproof rating when M12 connector mated with corresponding (IP67) M12 connector

Functionally equivalent components may be substituted

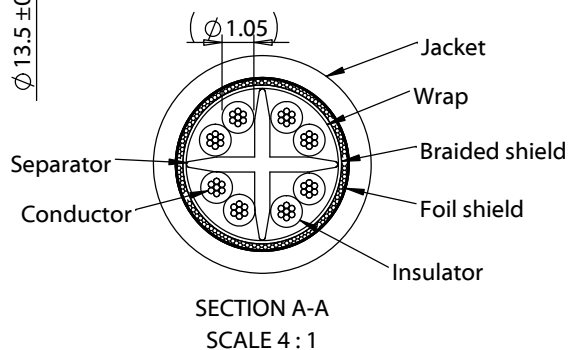

Wiring Diagram	
50-00993	wire color
1	orange/white
2	orange
3	green/white
4	green
5	brown/white
6	brown
7	blue/white
8	blue
Shell	shield

Revision:	Date:	Description:	Prepared:	Notes:	<h1>TENSILITY</h1> <p>tel 1.541.323.3228 800 877.670.7118 fax 1.541.323.4202 web tensility.com</p>
A	5/19/2022	Initial release	Verified:	RoHS compliant	
			Dimensions are in millimeters. Tolerances: X: ± 0.5 mm X.X: ± 0.3 mm X.XX: ± 0.3 mm	Function test: no open, no short circuit, no intermittent	
				Description: Cable, 1500 mm, 8 pin 50-00993 M12 X-code plug to blunt cut, CAT6a, 24 AWG, 30-01713 wire	
Scale: 1:1		Part number: 10-03978		Sheet 1 of 1	

5

4

3

2

1