

APPROVED: _____
 DATE: _____ TITLE: _____

Rev	AWO #	Description	Date	Appr
-		RELEASED	3/6/19	

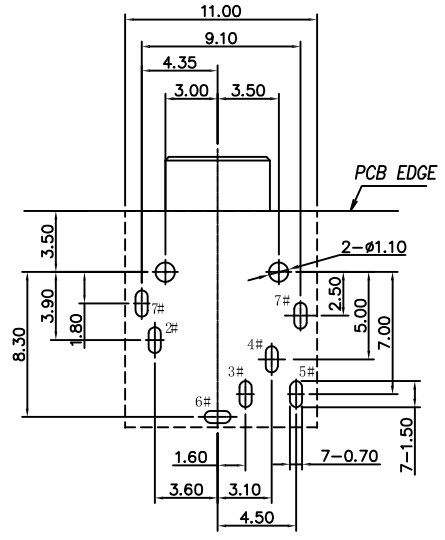

RECOMMENDED PCB LAYOUT

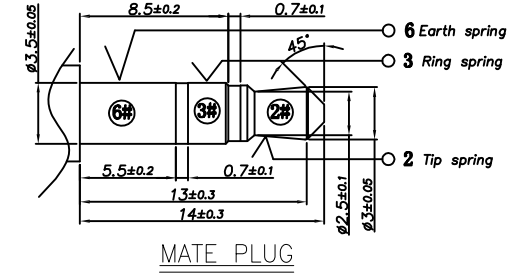
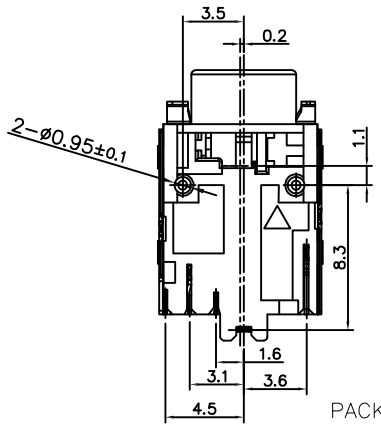
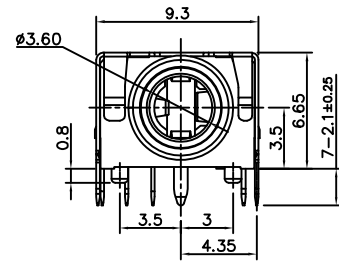
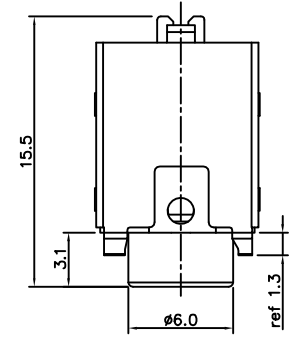

MATE PLUG

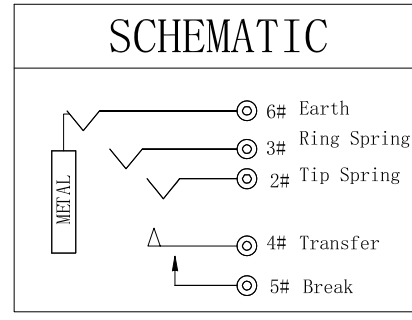
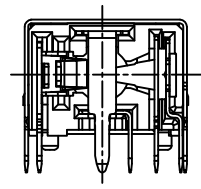
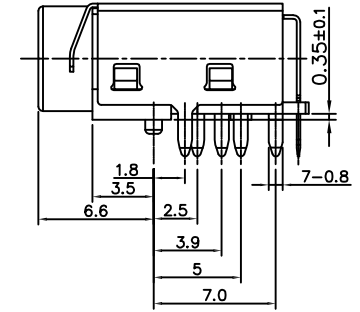

SPECIFICATIONS:
 Material:
 Insulator: PA10T, rated UL 94V-0
 Insulator color: Black
 Contacts: Phosphor Bronze
 Shielding: Stainless Steel, Nickel plated
 Transfer: Phosphor Bronze, Gold flash Contact
 Separator: Hi-Temp Thermoplastic, Color: Black
 Metal: Brass, Nickel plated
 Plating:
 Gold flash over Nickel underplate on contact area,
 Matte Tin over Nickel underplate on solder tails
 Electrical:
 Rating: 12V, 1A
 Contact resistance: 50 mohms max
 Insulation resistance: 100 Mohms min @ 500 VDC
 Dielectric withstanding voltage: 500 VAC
 Temperature Rating:
 Operating temperature: -20°C to +70°C
 Environmental:
 Lead free, RoHS compliant.



PACKAGED ON TAPE & REEL

UNLESS OTHERWISE SPECIFIED ALL DIMENSIONS ARE MILLIMETERS TOLERANCES: EXCEPT AS NOTED	
MM	ANGLE
X. ± 0.30	X ± 5°
.X ± 0.20	.X ± 3°
.XX ± 0.10	.XX ± 2°
.XXX ± 0.05	
APPROVALS	
DRAWN	AY
CHECKED	TW
APPROVED	
DATE	
3/6/19	
3/6/19	

ADAM TECH INTERCONNECTS 909 Rahway Avenue, Union, NJ 07083
 Phone: 908-687-5000 Fax: 908-687-5710

TITLE: STEREO JACK, 3.5MM, RIGHT ANGLE
 PCB MOUNT THRU HOLE

SIZE	PART NO.	REV.
X	ASJ-193B-L-T/R	-

REF: S00002C SCALE: NTS SHEET 1 OF 1

6 5 4 3 2 1

D

D

C

C

B

B

A

A

6 5 4 3 2 1