

White High-Intensity LED Lamp (3 mm, 40° Viewing Angle)



OVLAW4CB7

Features:

- High luminous intensity
- Through-hole type
- Clear lens
- High efficiency



Description:

The OVLAW4CB7 is a round 3mm white high-intensity through-hole lamp with a 40° viewing angle. It is designed for wide-angle uniform light output.

Applications:

- Indicators for medical, industrial, consumer and office equipment
- Indicators for white goods and home appliances
- Interior and exterior architectural and accent lighting
- Signs and digital information displays, video screen non-color and RGB presentation
- Automotive backlighting and indicators

Part Number	Material	Emitted Color	Intensity Typ. mcd	Lens Color
OVLAW4CB7	InGaN	White	6200	Clear

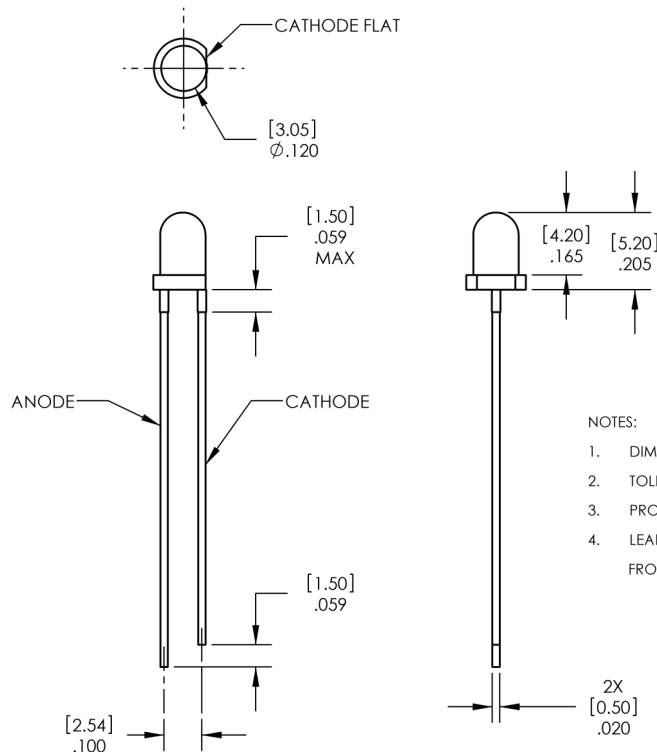

RoHS

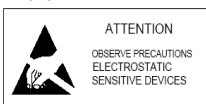

DO NOT LOOK DIRECTLY AT LED WITH UNSHIELDED EYES OR DAMAGE TO RETINA MAY OCCUR.

General Note

TT Electronics reserves the right to make changes in product specification without notice or liability. All information is subject to TT Electronics' own data and is considered accurate at time of going to print.

TT Electronics | OPTEK Technology
2900 E. Plano Pkwy, Plano, TX 75074 | Ph: +1 972 323 2200
www.ttelectronics.com | sensors@ttelectronics.com

White High-Intensity LED Lamp (3 mm, 40° Viewing Angle)



OVLAW4CB7

Electrical Specifications

Absolute Maximum Ratings ($T_A = 25^\circ\text{C}$ unless otherwise noted)

Storage Temperature Range	-40 ~ +100° C
Operating Temperature Range	-40 ~ +100° C
Reverse Voltage	5 V
Power Dissipation	100 mW
Average Forward Current	25 mA
Peak Forward Current (Duty Ratio = 1/10, Pulse Width = 0.1ms)	100 mA
Current Linearity vs Ambient Temperature	-0.29 mA/° C
LED Junction Temperature	125° C
Electrostatic Discharge Classification (JEDEC-JESD22-A114F)	Class 1C
Lead Soldering Temperature (5 seconds maximum)	260° C
Lead Soldering Temperature (5 seconds maximum)	260° C

Electrical Characteristics ($T_A = 25^\circ\text{C}$ unless otherwise noted)

SYMBOL	PARAMETER	MIN	TYP	MAX	UNITS	TEST CONDITIONS
I_V	Luminous Intensity	4,360	6,200	----	mcd	$I_F = 20\text{ mA}$
$2\theta_{\frac{1}{2}}$	50% Power Angle	----	40	----	deg	$I_F = 20\text{ mA}$
V_F	Forward Voltage	----	3.2	4.0	V	$I_F = 20\text{ mA}$
I_R	Reverse Current	----	----	10	μA	$V_R = 5\text{ V}$
x	Chromaticity Coordinates	----	0.31	----	----	$I_F = 20\text{ mA}$
y	Chromaticity Coordinates	----	0.32	----	----	$I_F = 20\text{ mA}$

General Note

TT Electronics reserves the right to make changes in product specification without notice or liability. All information is subject to TT Electronics' own data and is considered accurate at time of going to print.

TT Electronics | OPTEK Technology
2900 E. Plano Pkwy, Plano, TX 75074 | Ph: +1 972 323 2200
www.ttelectronics.com | sensors@ttelectronics.com

White High-Intensity LED Lamp (3 mm, 40° Viewing Angle)



OVLAW4CB7

Typical Electro-Optical Characteristics Curves

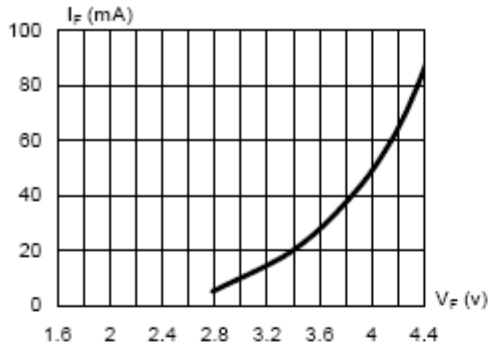

Fig. 1 Forward Current vs Forward Voltage

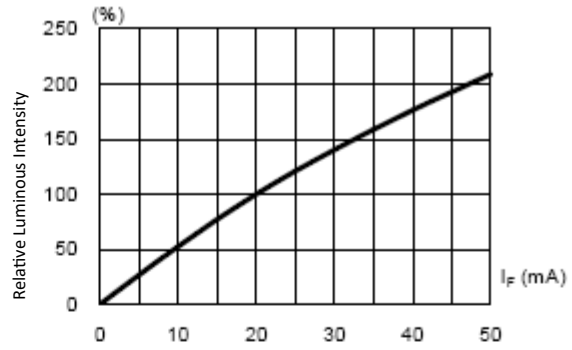

Fig. 2 Luminous Intensity vs. Forward Current

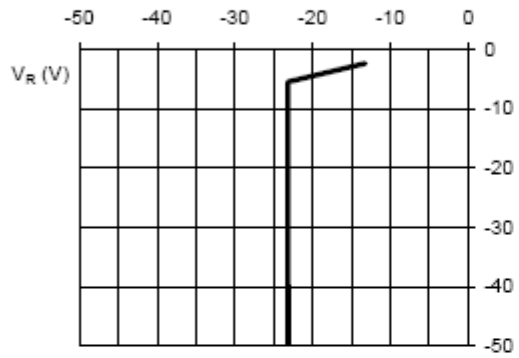

Fig. 3 Reverse Current vs. Reverse Voltage I_R (μ A)

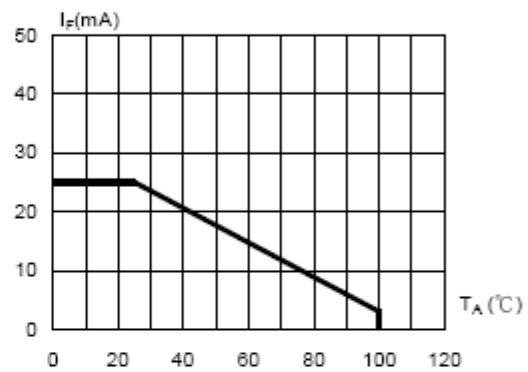

Fig. 4 Allowable Forward Current vs. Ambient Temperature

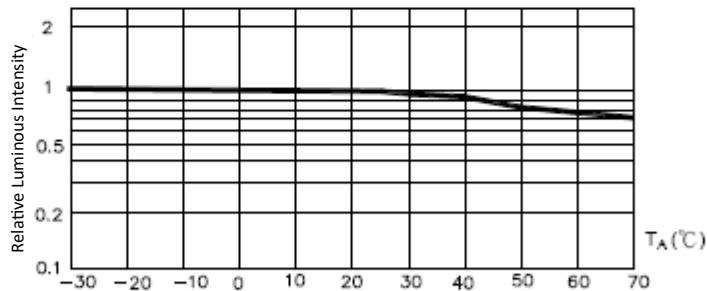

Fig. 5 Luminous Intensity at $I_f = 20$ mA vs. Ambient Temperature

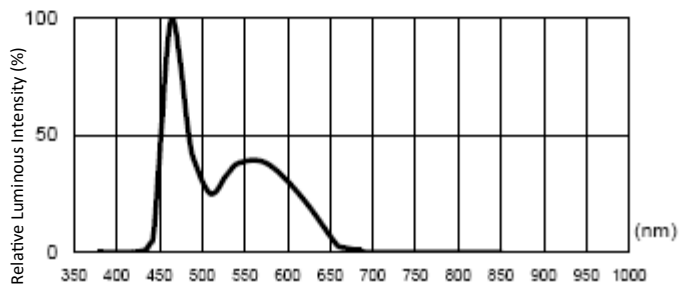

Fig. 6 Relative Luminous Intensity vs. Wavelength

General Note

TT Electronics reserves the right to make changes in product specification without notice or liability. All information is subject to TT Electronics' own data and is considered accurate at time of going to print.

TT Electronics | OPTEK Technology
2900 E. Plano Pkwy, Plano, TX 75074 | Ph: +1 972 323 2200
www.ttelectronics.com | sensors@ttelectronics.com

White High-Intensity LED Lamp (3 mm, 40° Viewing Angle)



OVLAW4CB7

Beam Pattern

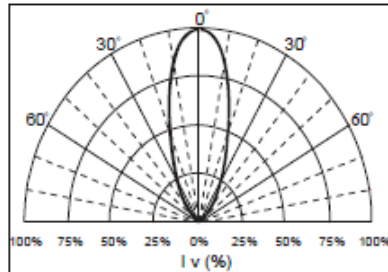

Soldering:

Soldering heat may damage the LED. Careful attention should be paid during the soldering process and PCB assembly. In order to eliminate the stress of heat shock, please solder the LEDs no closer than 3mm from the base of the epoxy bulb.

Recommended Soldering Conditions:

	Wave Soldering	Manual Solder Dipping	Hand Soldering by Iron
Pre-heat Temperature	105°C Max		
Pre-heat Time	30 seconds Max		
Peak Temperature	250°C Max	260°C Max	350°C Max
Dwell Time	3 seconds Max	5 seconds Max	3 seconds Max

Packaging: 500 pcs per bulk bag

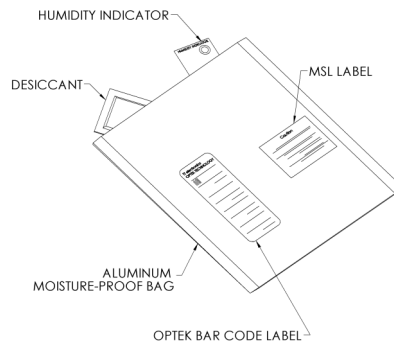

General Note

TT Electronics reserves the right to make changes in product specification without notice or liability. All information is subject to TT Electronics' own data and is considered accurate at time of going to print.

TT Electronics | OPTEK Technology
 2900 E. Plano Pkwy, Plano, TX 75074 | Ph: +1 972 323 2200
www.ttelectronics.com | sensors@ttelectronics.com

White High-Intensity LED Lamp (3 mm, 40° Viewing Angle)



OVLAW4CB7

Reliability Test

LED lamps are checked by reliability tests based on MIL standards.

1. Test Conditions, Acceptable Criteria & Results:

Classification	Test Item	Standard Test Method	Test Conditions	Duration	Unit	Acc / Rej Criteria	Result
Life Test	Operation Life Test (OLT)	MIL-STD-750D Method 1026.3	$T_A=25^{\circ}\text{C}$, $I_F=30\text{mA}$ *	1000 Hrs	100	0 / 1	Pass
Environment Test	High Temperature Storage (HTS)	MIL-STD-750D Method 1032.1	$T_A=100^{\circ}\text{C}$	1000 Hrs	100	0 / 1	Pass
	Low Temperature Storage (LTS)	MIL-STD-750D Method 1032.1	$T_A=-40^{\circ}\text{C}$	1000 Hrs	100	0 / 1	Pass
	Temp. & Humidity with Bias (THB)	MIL-STD-750D Method 103B	$T_A=85^{\circ}\text{C}$, $R_h=85\%$ $I_F=20\text{mA}$ **	500 Hrs	100	0 / 1	Pass
	Thermal Shock Test (TST)	MIL-STD-750D Method 1056.1	0°C ~ 100°C 2min 2min	100 cycles	100	0 / 1	Pass
	Temperature Cycling Test (TCT)	MIL-STD-750D Method 1051.5	-40°C ~ 25°C ~ 100°C ~ 25°C 30min 5min 30min 5min	100 cycles	100	0 / 1	Pass
Mechanical Test	Solderability	MIL-STD-750D Method 2026.4	$235\pm 5^{\circ}\text{C}$, 5 sec	1 time	20	0 / 1	Pass
	Resistance to Soldering Heat	MIL-STD-750D Method 2031.1	$260\pm 5^{\circ}\text{C}$, 5 sec	1 time	20	0 / 1	Pass
	Lead Integrity	MIL-STD-750D Method 2036.3	Load 2.5N (0.25kgf) 0° ~ 90° ~ 0° , bend	3 times	20	0 / 1	Pass

Remark : (*) $I_F=30\text{mA}$ for AlInGaP chip ; $I_F=20\text{mA}$ for InGaN chip

(**) $I_F=20\text{mA}$ for AlInGaP chip ; $I_F=10\text{mA}$ for InGaN chip

2. Failure Criteria ($T_A=25^{\circ}\text{C}$):

Test Item	Symbol	Test Conditions	Criteria for Judgment	
			Min.	Max.
Luminous Intensity	I_V	$I_F=20\text{ mA}$	$LSL \times 0.7$ **	
Forward Voltage	V_F	$I_F=20\text{ mA}$		$USL \times 1.1$ *

(*) USL : Upper Standard Level , (**) LSL : Lower Standard Level

General Note

TT Electronics reserves the right to make changes in product specification without notice or liability. All information is subject to TT Electronics' own data and is considered accurate at time of going to print.

TT Electronics | OPTEK Technology
2900 E. Plano Pkwy, Plano, TX 75074 | Ph: +1 972 323 2200
www.ttelectronics.com | sensors@ttelectronics.com