

RECOMMENDED PCB(CONNECTOR SIDE VIEW)  
THICKNESS=1.6 TO 2.4 MM

|                    |   |   |  |                 |                          |
|--------------------|---|---|--|-----------------|--------------------------|
| FUNCTIONAL SYMBOLS | THIS DRAWING CONTAINS INFORMATION THAT IS PROPRIETARY TO MOLEX ELECTRONIC TECHNOLOGIES, LLC AND SHOULD NOT BE USED WITHOUT WRITTEN PERMISSION |   | CURRENT REV DESC:  |                 | <b>molex</b>             |
|                    | $\nabla_A = 0$<br>$\nabla_B = 0$<br>$\nabla_C = 0$  | DIMENSION UNITS: <b>mm</b><br>SCALE: <b>5:1</b> | EC NO: 697101<br>DRWN: GLLI<br>CHK'D: XQZHANG<br>APPR: XQZHANG |                 |                          |
| DIVISIONAL SYMBOLS | GENERAL TOLERANCES (UNLESS SPECIFIED)   |   | 2022/02/24   |                 | PRODUCT CUSTOMER DRAWING |
|                    | ANGULAR TOL $\pm 3.0^\circ$   |   | 2022/02/25   |                 |                          |
|                    | 4 PLACES $\pm$  | INITIAL REVISION:                               |  | DOCUMENT NUMBER | DOC TYPE                 |
|                    | 3 PLACES $\pm 0.1$  | DRWN: GLLI                                      |  | 1053121000-SD   | PSD                      |
| 2 PLACES $\pm 0.2$ | APPR: YXZHENG   |   | 2019/09/24   | DOC PART        | REVISION                 |
| 1 PLACE $\pm 0.3$  | DRAFT WHERE APPLICABLE MUST REMAIN WITHIN DIMENSIONS  |   | 2020/03/16   | 000             | B1                       |
| 0 PLACES $\pm$     | THIRD ANGLE PROJECTION  | DRAWING   | SERIES   | MATERIAL NUMBER | CUSTOMER                 |
|                    |   | A3-SIZE   | 105312   |                 | GENERAL MARKET           |
|                    |   |   |  |                 | SHEET NUMBER             |
|                    |   |   |  |                 | 1 OF 5                   |

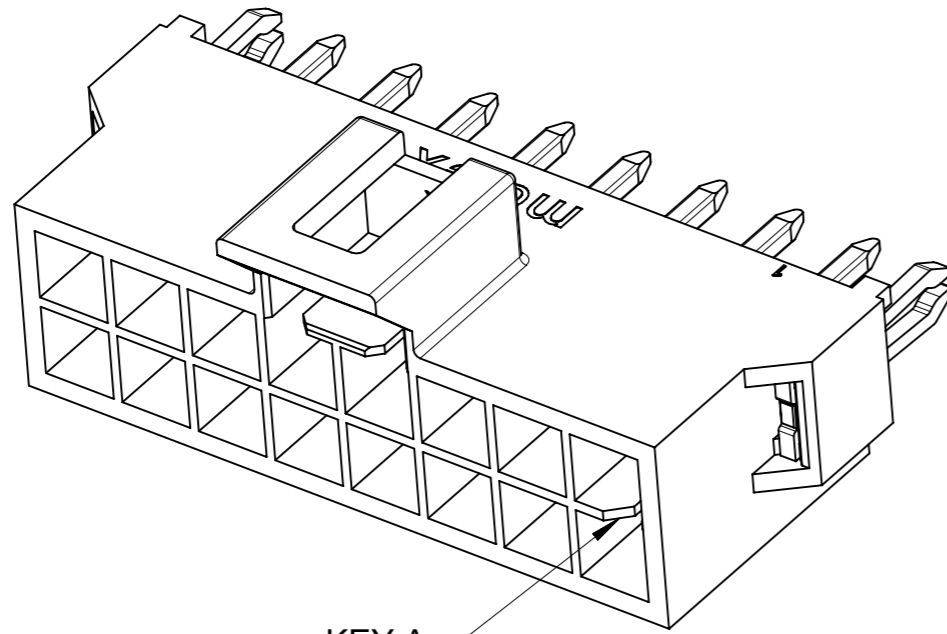

KEY A

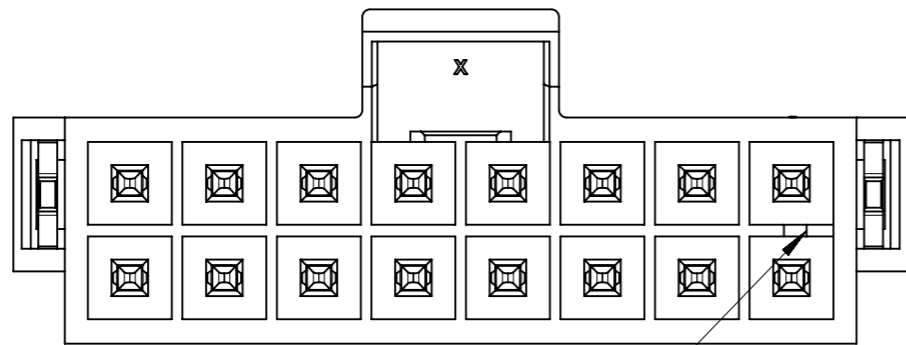

KEY A

BLACK

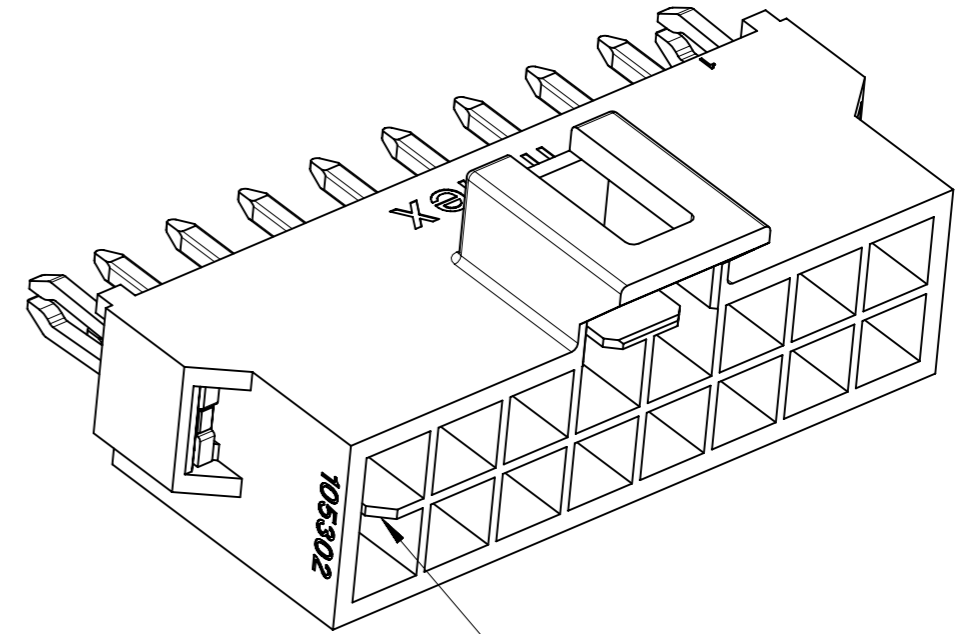

KEY B

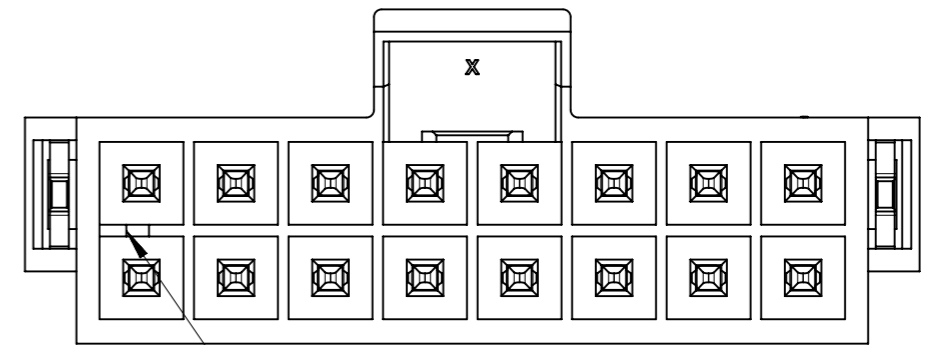

KEY B

NATURAL

COLOR OPTION

|  |   |                        |  |        |   |                          |              |           |
|--|---|------------------------|--|--------|---|--------------------------|--------------|-----------|
| FUNCTIONAL SYMBOLS                                   | THIS DRAWING CONTAINS INFORMATION THAT IS PROPRIETARY TO MOLEX ELECTRONIC TECHNOLOGIES, LLC AND SHOULD NOT BE USED WITHOUT WRITTEN PERMISSION |                        | CURRENT REV DESC:  |        | <b>molex</b>  |                          |              |           |
|  | ▽A = 0  | mm                     |  |        |   |                          |              | SCALE 5:1 |
| ▽E = 0   | GENERAL TOLERANCES (UNLESS SPECIFIED)   |                        | EC NO: 697101<br>DRWN: GLLI<br>CHK'D: XQZHANG<br>APPR: XQZHANG<br>INITIAL REVISION:<br>DRWN: GLLI<br>APPR: YXZHENG |        | HEADER OF NANO-FIT, D/R, CLIP, VERTICAL POWER CONNECTOR |                          |              |           |
| ▽E = 0   | ANGULAR TOL ± 3.0°  |                        |  |        |   |                          |              |           |
| DIVISIONAL SYMBOLS                                   | 4 PLACES  | ±                      |  |        | 2022/02/24  | PRODUCT CUSTOMER DRAWING |              |           |
|  | 3 PLACES  | ± 0.1                  |  |        | 2022/02/25  |                          |              |           |
|  | 2 PLACES  | ± 0.2                  |  |        | 2022/02/25  | DOCUMENT NUMBER          |              |           |
| 1 PLACE  | ± 0.3   | 2019/09/24             | 1053121000-SD  |        |   | DOC TYPE                 | DOC PART     | REVISION  |
| 0 PLACES   | ±   | 2020/03/16             | GENERAL MARKET   |        |   | PSD                      | 000          | B1        |
| DRAFT WHERE APPLICABLE MUST REMAIN WITHIN DIMENSIONS |   | THIRD ANGLE PROJECTION | DRAWING  | SERIES | MATERIAL NUMBER   | CUSTOMER                 | SHEET NUMBER |           |
|  |   |                        | A3-SIZE  | 105312 |   | GENERAL MARKET           | 2 OF 5       |           |

|                 |    |              |            |          |
|-----------------|----|--------------|------------|----------|
| DOCUMENT STATUS | P1 | RELEASE DATE | 2022/02/25 | 03:08:44 |
|-----------------|----|--------------|------------|----------|

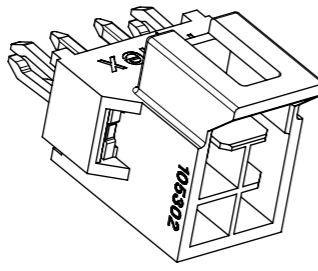
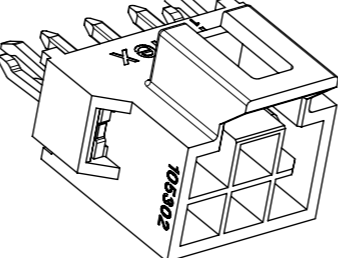
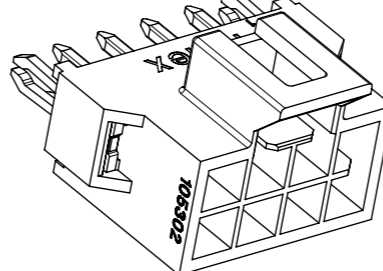
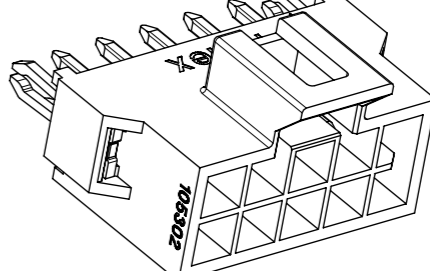
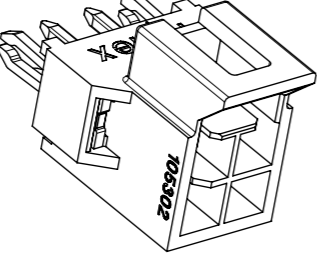
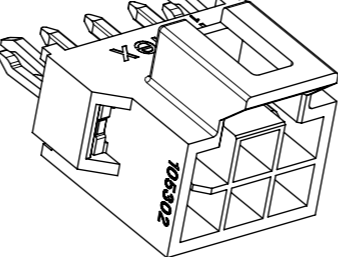
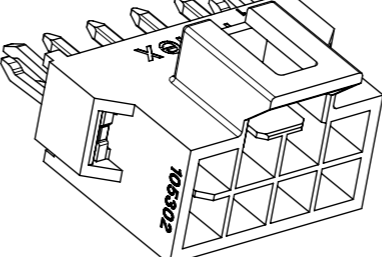
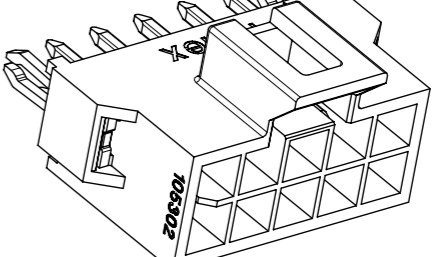
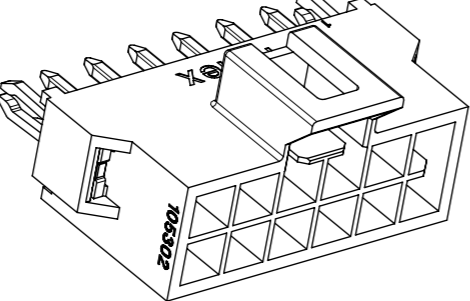
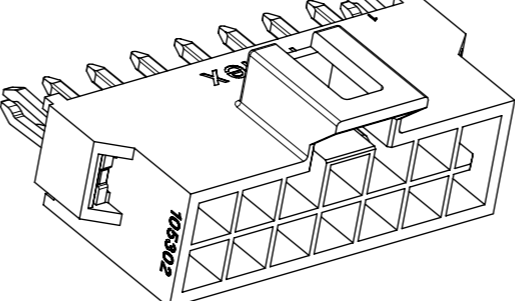
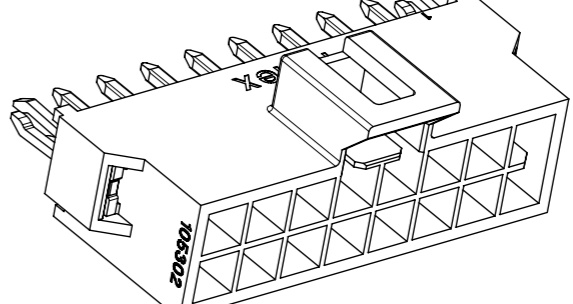
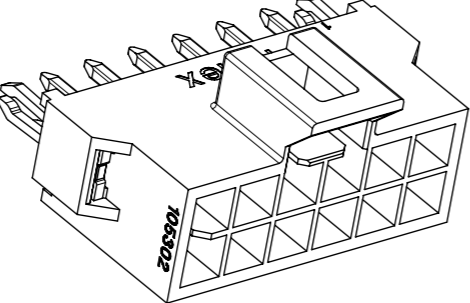
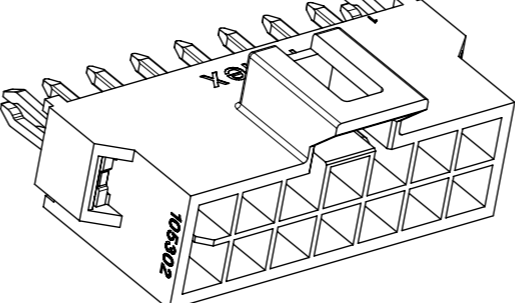
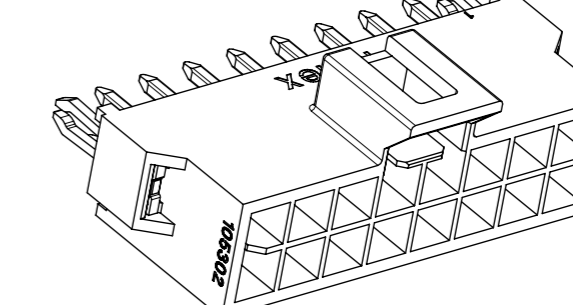

|   |         |  |   |   |   |
|---|---------|--|---|---|---|
|   |         | 4 CKT  | 6 CKT   | 8 CKT   | 10 CKT  |
| F | BLACK   |     |    |    |  |
| E | NATURAL |     |    |    |  |
|   |         | 12 CKT   | 14 CKT  | 16 CKT  |   |
| D | BLACK   |   |   |   |   |
| C | NATURAL |  |  |  |   |

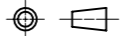
|  |   |     |                   |  |                 |  |          |
|--|---|-----|-------------------|--|-----------------|--|----------|
| FUNCTIONAL SYMBOLS                                   | THIS DRAWING CONTAINS INFORMATION THAT IS PROPRIETARY TO MOLEX ELECTRONIC TECHNOLOGIES, LLC AND SHOULD NOT BE USED WITHOUT WRITTEN PERMISSION |     | CURRENT REV DESC: |  | <b>molex</b>    |  |          |
|  | SCALE   | 3:1 |                   |  |                 |  |          |
| GENERAL TOLERANCES (UNLESS SPECIFIED)                | mm  |     | EC NO: 697101     |  | 2022/02/24      |  |          |
| ANGULAR TOL  | ± 3.0°  |     | DRWN: GLLI        |  | 2022/02/25      |  |          |
| 4 PLACES   | ±   |     | CHK'D: XQZHANG    |  | 2022/02/25      |  |          |
| 3 PLACES   | ± 0.1   |     | APPR: XQZHANG     |  | 2022/02/25      |  |          |
| 2 PLACES   | ± 0.2   |     | INITIAL REVISION: |  | DOCUMENT NUMBER |  |          |
| 1 PLACE  | ± 0.3   |     | DRWN: GLLI        |  | 1053121000-SD   |  | DOC TYPE |
| 0 PLACES   | ±   |     | APPR: YXZHENG     |  | PSD             |  | DOC PART |
| DRAFT WHERE APPLICABLE MUST REMAIN WITHIN DIMENSIONS | THIRD ANGLE PROJECTION  |     | DRAWING           |  | SERIES          |  | REVISION |
|  |    |     | A3-SIZE           |  | 105312          |  | B1       |
|  | MATERIAL NUMBER   |     | CUSTOMER          |  | SHEET NUMBER    |  |          |
|  | 105312  |     | GENERAL MARKET    |  | 4 OF 5          |  |          |

NOTES FOR ALL PARTS

1> MATERIAL:  
 HOUSING: LCP, UL 94V-0.  
 TERMINAL: BRASS.  
 SOLDER CLIP: BRASS.

2> PLATING FINISHED:  
 TERMINAL:  
 CONTACT AREA: a. REFLOW MATTE TIN 1.5MICRONS MIN;  
 b. GOLD 0.38 MICRONS MIN;  
 c. GOLD 0.76 MICRONS MIN.  
 SOLDER AREA: MATTE TIN 1.5 MICRONS MIN, UNDER PLATING NICKEL 1.25 MICRONS MIN.  
 SOLDER CLIP: MATTE TIN 2.5 MICRONS MIN, UNDER PLATING NICKEL 1.25 MICRONS MIN.

3> PRODUCT SPECIFICATION: PS-105300-100.  
 4> PACKAGE: TAPE REEL, 1053121000-PK.  
 5> PRODUCT MATE WITH SERIES OF 105308(RECEPTACLE), 105300(CRIMP TERMINAL).  
 6> PARTS CONFORM TO CLASS 'B'REQUIREMENTS OF COSMETIC SPECIFICATION PS-45499-002.  
 7> DISCOLORATION IN THE BANDOLIER PIN CARRIER AREA OF THE PIN IS INHERENT TO THE PLATING PROCESS AND IS DUE TO THE MASKING DEFECT OF THE CARRIER, THIS DISCOLORATION IS IN A NON-FUNCTION AREA OF THE PIN AND WILL NOT AFFECT THE PERFORMANCE OF THE HEADER ASSEMBLY.

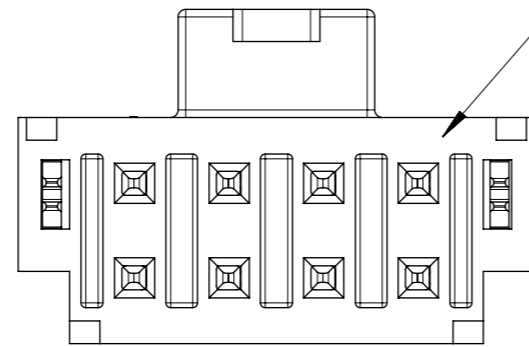

IF ANY NUMBER MARK APPEARS ON THIS SURFACE, PLEASE DISREGARD IT, IT IS NO ANY FUCTION AND NO ANY RELATION TO PIN NUMBER, IT IS JUST FOR MOLDING IDENDIFICATION.

|                    |   |                        |   |               |   |                         |                     |          |           |          |
|--------------------|---|------------------------|---|---------------|---|-------------------------|---------------------|----------|-----------|----------|
| FUNCTIONAL SYMBOLS | THIS DRAWING CONTAINS INFORMATION THAT IS PROPRIETARY TO MOLEX ELECTRONIC TECHNOLOGIES, LLC AND SHOULD NOT BE USED WITHOUT WRITTEN PERMISSION |                        | CURRENT REV DESC:   |               | <b>molex</b>  |                         |                     |          |           |          |
|                    | △/A = 0   | mm                     |   |               |   |                         |                     |          | SCALE 1:1 |          |
| DIVISIONAL SYMBOLS | GENERAL TOLERANCES (UNLESS SPECIFIED)   |                        | EC NO: 697101<br>DRWN: GLLI 2022/02/24<br>CHK'D: XQZHANG 2022/02/25<br>APPR: XQZHANG 2022/02/25 |               | HEADER OF NANO-FIT, D/R, CLIP, VERTICAL POWER CONNECTOR |                         |                     |          |           |          |
|                    | △/E = 0   | ANGULAR TOL ± 3.0 °    |   |               | PRODUCT CUSTOMER DRAWING                                |                         |                     |          |           |          |
|                    | △/F = 0   | 4 PLACES ±             |   |               | INITIAL REVISION:                                       |                         | DOCUMENT NUMBER     | DOC TYPE | DOC PART  | REVISION |
|                    |   | 3 PLACES ± 0.1         |   |               | DRWN: GLLI 2019/09/24                                   | 1053121000-SD           | PSD                 | 000      | B1        |          |
|                    |   | 2 PLACES ± 0.2         |   |               | APPR: YXZHENG 2020/03/16                                |                         |                     |          |           |          |
|                    | 1 PLACE ± 0.3   |                        |   |               |   |                         |                     |          |           |          |
|                    | 0 PLACES ±  |                        |   |               |   |                         |                     |          |           |          |
|                    | DRAFT WHERE APPLICABLE MUST REMAIN WITHIN DIMENSIONS  | THIRD ANGLE PROJECTION | DRAWING A3-SIZE   | SERIES 105312 | MATERIAL NUMBER   | CUSTOMER GENERAL MARKET | SHEET NUMBER 5 OF 5 |          |           |          |