

SERIES: VQA3S-S | **DESCRIPTION:** IGBT DRIVER DC-DC

FEATURES

- designed for SiC driver applications
- reinforced insulation
- CMTI > 200 kV/μs
- ultra-low isolation capacitance 3.5pF (typ.)
- -40 ~ 105°C temperature range
- continuous short circuit protection
- 5 kVac isolation test voltage
- UL/cUL 62368 certified

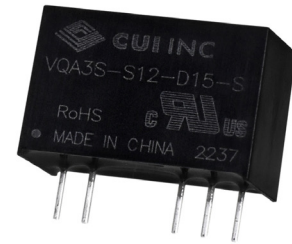

MODEL

MODEL	input voltage		output voltage	output current	ripple and noise ¹	efficiency
	typ (Vdc)	range (Vdc)	(Vdc)	max (mA)	max (mVp-p)	typ (%)
VQA3S-S5-D15-S	5	4.5~5.5	15 -5	80 -40	150	82
VQA3S-S5-D18-S	5	4.5~5.5	18 -3.5	80 -80	150	82
VQA3S-S5-D20-S	5	4.5~5.5	20 -4	80 -40	150	82
VQA3S-S12-D15-S	12	10.8~13.2	15 -2.5	100 -100	100	87
VQA3S-S12-DX15-S	12	10.8~13.2	15 -4	120 -120	100	87
VQA3S-S12-D18-S	12	10.8~13.2	18 -3	100 -100	100	87
VQA3S-S12-D20-S	12	10.8~13.2	20 -5	90 -90	100	87
VQA3S-S15-D15-S	15	13.5~16.5	15 -4	120 -120	100	87
VQA3S-S15-D20-S	15	13.5~16.5	20 -5	90 -90	100	87
VQA3S-S24-D15-S	24	21.6~26.4	15 -4	120 -120	100	82
VQA3S-S24-D20-S	24	21.6~26.4	20 -5	90 -90	100	81

Notes: 1. Ripple and noise are measured at 20 MHz BW by "parallel cable" method. See application notes.

PART NUMBER KEY

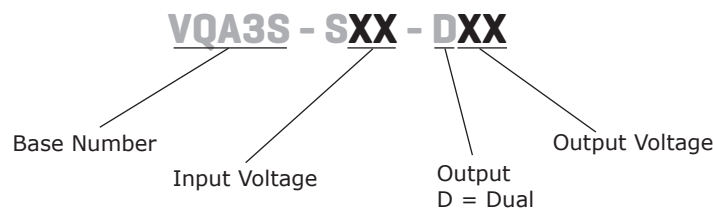

INPUT

parameter	conditions/description	min	typ	max	units
surge voltage ²	5 Vdc input model	-0.7		9	Vdc
	12 Vdc input model	-0.7		18	Vdc
	15 Vdc input model	-0.7		21	Vdc
	24 Vdc input model	-0.7		30	Vdc

input filter capacitance filter

Note: 2. For 1 second maximum.

OUTPUT

parameter	conditions/description	min	typ	max	units		
output voltage	VQA3S-S5-D15-S	+Vo Pin6 & Pin7 +Io=80mA -Vo Pin5 & Pin6 -Io=-40mA	14.55 -4.45	15.3 -4.7	16.05 -4.95	Vdc Vdc	
	VQA3S-S5-D18-S	+Vo Pin6 & Pin7 +Io=80mA -Vo Pin5 & Pin6 +Io=-80mA	16.74 -3.13	17.64 -3.3	18.54 -3.67	Vdc Vdc	
	VQA3S-S5-D20-S	+Vo Pin6 & Pin7 +Io=80mA -Vo Pin5 & Pin6 -Io=-40mA	18.8 -3.8	19.8 -4	20.8 -4.2	Vdc Vdc	
	VQA3S-S12-D15-S	+Vo Pin6 & Pin7 +Io=100mA -Vo Pin5 & Pin6 -Io=-100mA	13.86 -2.28	14.61 -2.40	15.36 -2.53	Vdc Vdc	
	VQA3S-S12-DX15-S	+Vo Pin6 & Pin7 +Io=120mA -Vo Pin5 & Pin6 -Io=-120mA	14.25 -3.60	15.00 -3.80	15.75 -4.00	Vdc Vdc	
	VQA3S-S12-D18-S	+Vo Pin6 & Pin7 +Io=100mA -Vo Pin5 & Pin6 -Io=-100mA	17.10 -3.00	18.00 -3.15	18.90 -3.30	Vdc Vdc	
	VQA3S-S12-D20-S	+Vo Pin6 & Pin7 +Io=90mA -Vo Pin5 & Pin6 -Io=-90mA	18.50 -4.95	19.50 -5.20	20.50 -5.45	Vdc Vdc	
	VQA3S-S15-D15-S	+Vo Pin6 & Pin7 +Io=120mA -Vo Pin5 & Pin6 -Io=-120mA	13.76 -3.80	14.51 -4.00	15.26 -4.20	Vdc Vdc	
	VQA3S-S15-D20-S	+Vo Pin6 & Pin7 +Io=90mA -Vo Pin5 & Pin6 -Io=-90mA	18.50 -4.95	19.50 -5.20	20.50 -5.45	Vdc Vdc	
	VQA3S-S24-D15-S	+Vo Pin6 & Pin7 +Io=120mA -Vo Pin5 & Pin6 -Io=-120mA	14.55 -3.96	15.30 -4.16	16.05 -4.36	Vdc Vdc	
	VQA3S-S24-D24-S	+Vo Pin6 & Pin7 +Io=90mA -Vo Pin5 & Pin6 -Io=-90mA	19.00 -4.75	20.00 -5.00	21.00 -5.25	Vdc Vdc	
	capacitive load	5 Vdc input models	15 Vdc output 18 Vdc output 20 Vdc output			1,000 680 470	μF μF μF
		12 Vdc input models	15 Vdc output 18 Vdc output 20 Vdc output			2,200 1,000 470	μF μF μF
		15 Vdc input model	15 Vdc output 20 Vdc output			2,200 2,200	μF μF
		24 Vdc input models	15 Vdc output 20 Vdc output			2,200 2,200	μF μF
	line regulation	5 Vdc input models		1.1	1.4	%	
all other inputs			1.1	1.5	%		
load regulation ³	5 Vdc input models	+Vo output -Vo output		8 10	15 15	% %	
	VQA3S-S12-D15-S	+Vo output -Vo output		8 13	17 17	% %	
	all other inputs	+Vo output		6	15	%	
		-Vo output		8	15	%	
temperature coefficient	at full load		±0.04	±0.1	%/°C		
switching frequency	at full load, nominal input		200		kHz		
CMTI	input to output		±200		kV/μs		

Note: 3. At 10 ~ 100% load

PROTECTIONS

parameter	conditions/description	min	typ	max	units
short circuit protection	continuous, auto-recovery				

SAFETY AND COMPLIANCE

parameter	conditions/description	min	typ	max	units
isolation voltage	input to output for 1 minute, 1 mA max	5,600			Vdc
partial discharge	input to output according to IEC 61800-5-1	1,700			V
isolation resistance	input to output at 500 Vdc	1,000			MΩ
isolation capacitance	input to output, 100 kHz/0.1 V		3.5	5	pF
safety approvals	certified to 62368: UL/cUL designed to meet 62368: EN/IEC				
conducted emissions	5 Vdc input model: CISPR32/EN55032 CLASS B (see recommended circuit) other models: CISPR32/EN55032 CLASS A (see recommended circuit)				
radiated emissions	5 Vdc input model: CISPR32/EN55032 CLASS B (see recommended circuit) other models: CISPR32/EN55032 CLASS A (see recommended circuit)				
ESD	5 Vdc input models: IEC/EN 61000-4-2 Contact ±6kV, perf. Criteria B other models: IEC/EN 61000-4-2 Contact ±8kV, perf. Criteria B				
MTBF	as per MIL-HDBK-217F at 25°C	3,500,000			hours
RoHS	yes				

ENVIRONMENTAL

parameter	conditions/description	min	typ	max	units
operating temperature	see derating curve	-40		105	°C
storage temperature		-55		125	°C
storage humidity	non-condensing	5		95	%

SOLDERABILITY

parameter	conditions/description	min	typ	max	units
pin soldering temperature	1.5mm from case for 10 seconds			300	°C

MECHANICAL

parameter	conditions/description	min	typ	max	units
dimensions	19.50 x 9.80 x 12.5 (0.768 x 0.386 x 0.492 inch)				mm
material	plastic, flame retardant and heat resistant				
weight			4.3		g
cooling method	natural convection				

MECHANICAL DRAWING

units: mm [inches]
 tolerance: ± 0.50 [± 0.020]
 pin section tolerance: ± 0.10 [± 0.004]

PIN CONNECTIONS	
PIN	FUNCTION
1	Vin
2	GND
5	-Vo
6	0V
7	+Vo

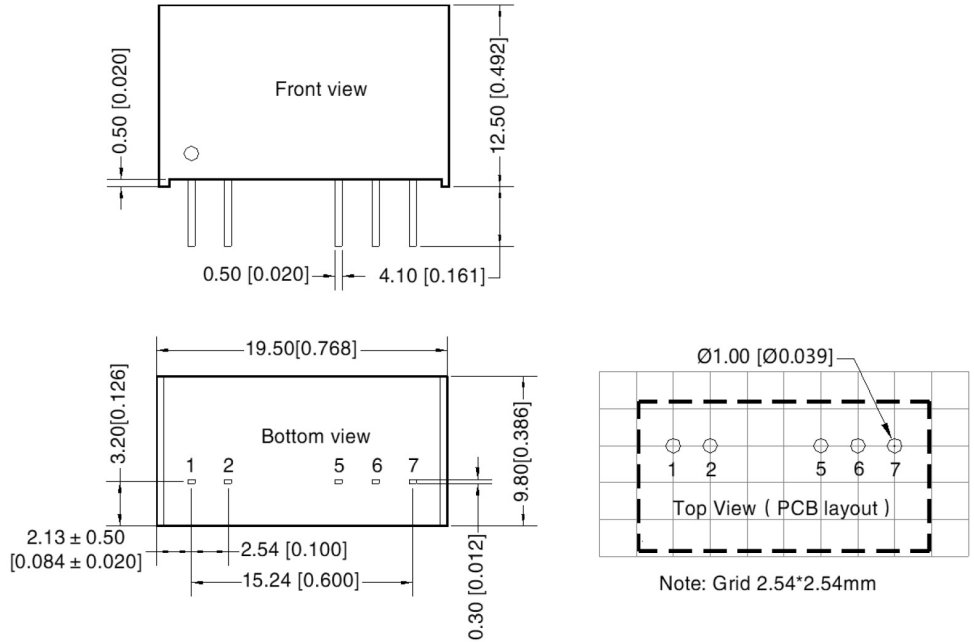

DERATING CURVES

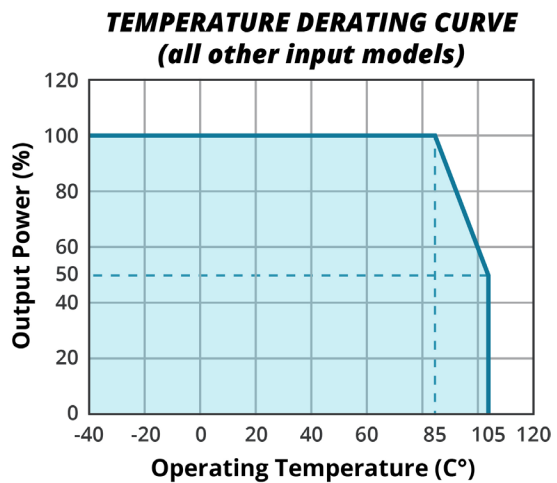
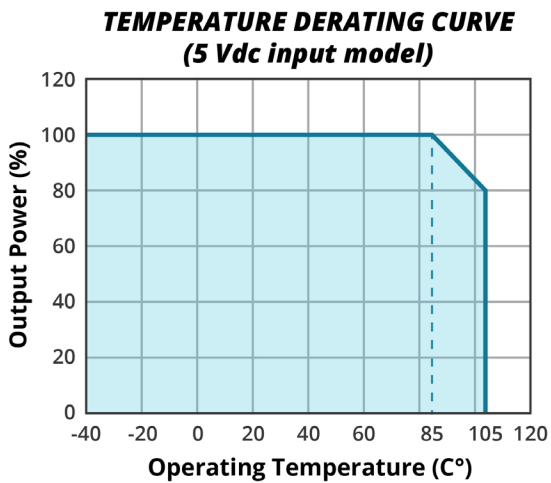

REGULATION CURVES

OUTPUT REGULATION CURVE
VQA3S-S5-D15-S
(+Vo)

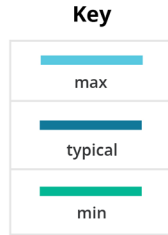
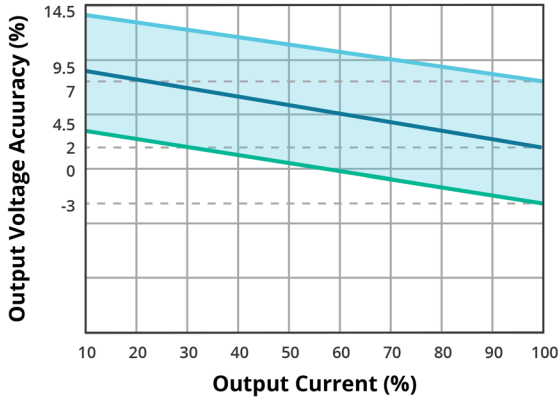

OUTPUT REGULATION CURVE
VQA3S-S5-D15-S
(-Vo)

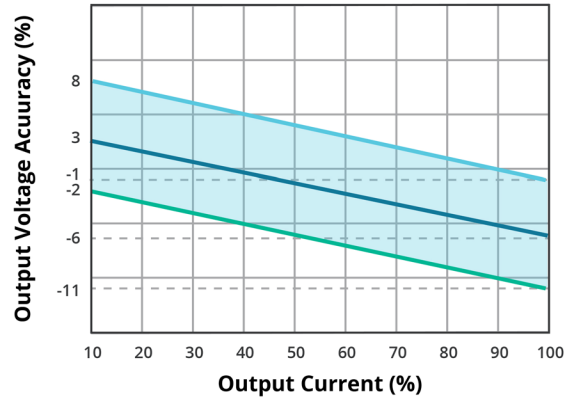

OUTPUT REGULATION CURVE
VQA3S-S5-D18-S
(+Vo)

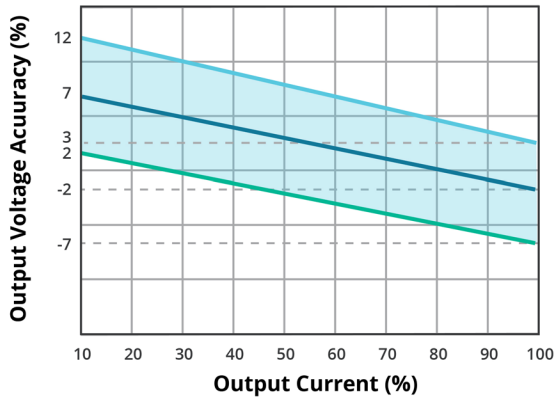

OUTPUT REGULATION CURVE
VQA3S-S5-D18-S
(-Vo)

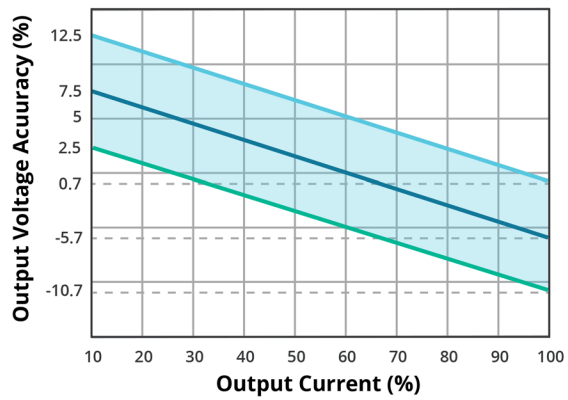

OUTPUT REGULATION CURVE
VQA3S-S5-D20-S
(+Vo)

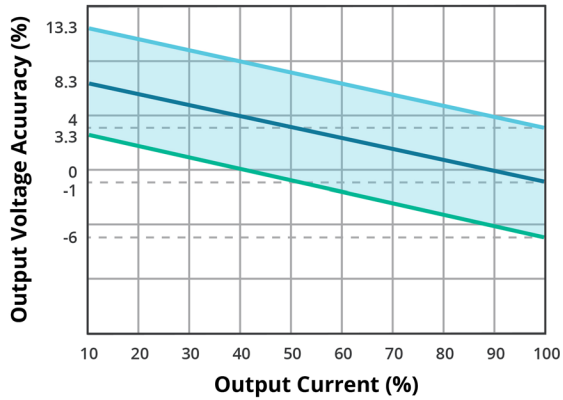

OUTPUT REGULATION CURVE
VQA3S-S5-D20-S
(-Vo)

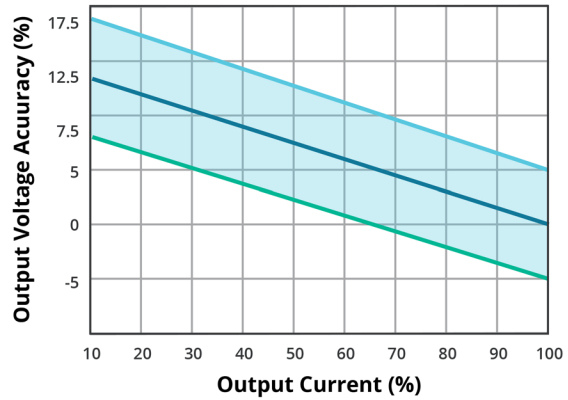

REGULATION CURVES (CONTINUED)

OUTPUT REGULATION CURVE
VQA3S-S12-D15-S
(+Vo)

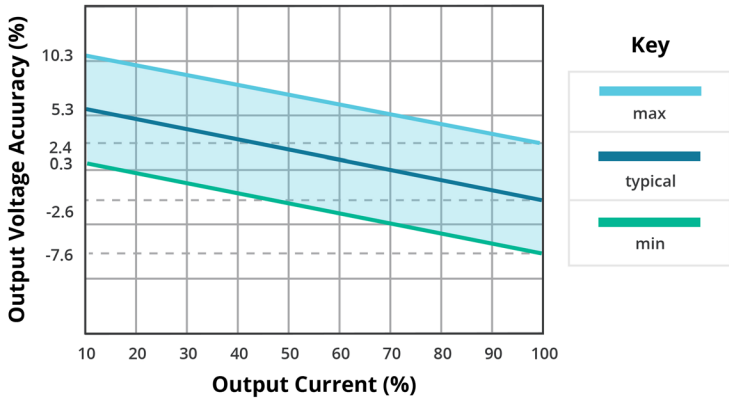

OUTPUT REGULATION CURVE
VQA3S-S12-D15-S
(-Vo)

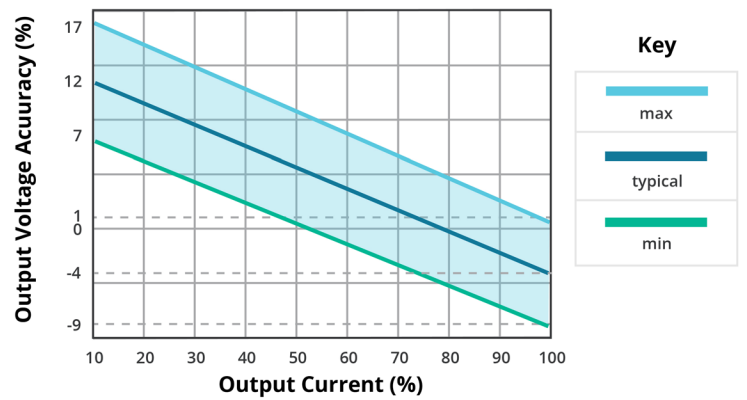

OUTPUT REGULATION CURVE
VQA3S-S12-DX15-S
(+Vo)

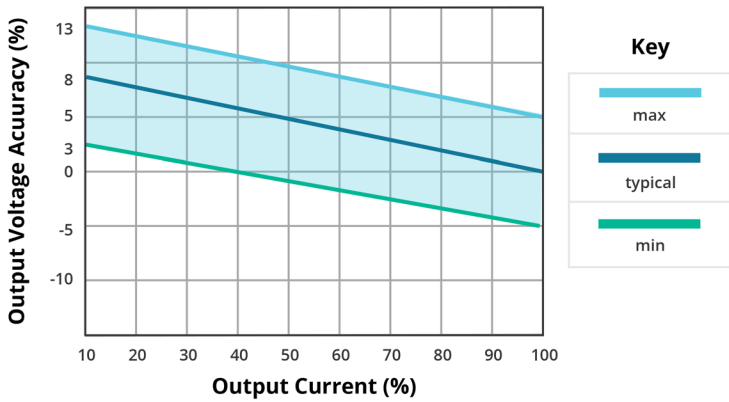

OUTPUT REGULATION CURVE
VQA3S-S12-DX15-S
(-Vo)

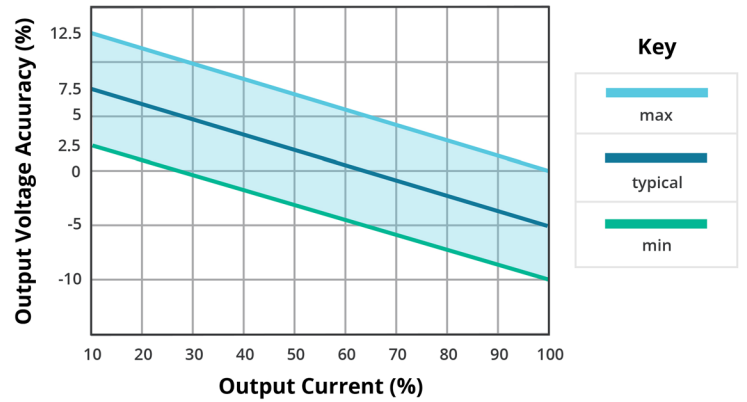

OUTPUT REGULATION CURVE
VQA3S-S12-D18-S
(+Vo)

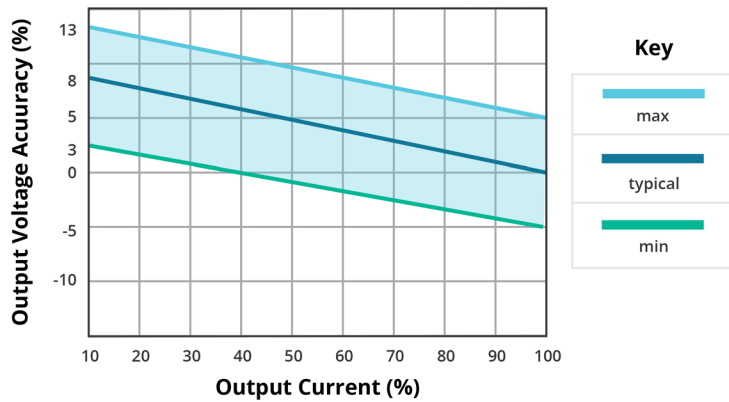

OUTPUT REGULATION CURVE
VQA3S-S12-D18-S
(-Vo)

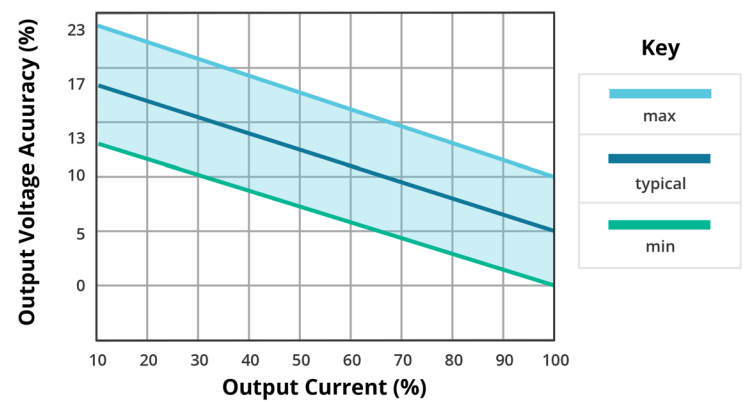

REGULATION CURVES (CONTINUED)

OUTPUT REGULATION CURVE
VQA3S-S12-D20-S
(+Vo)

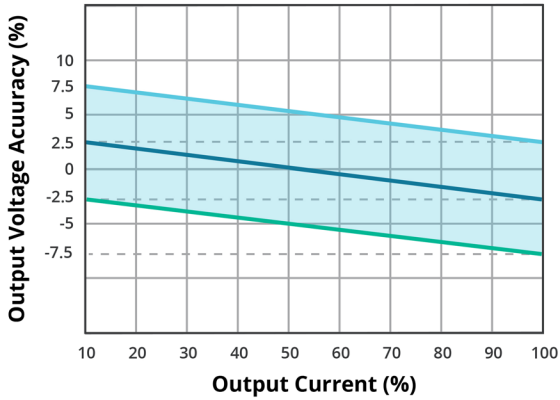

OUTPUT REGULATION CURVE
VQA3S-S12-D20-S
(-Vo)

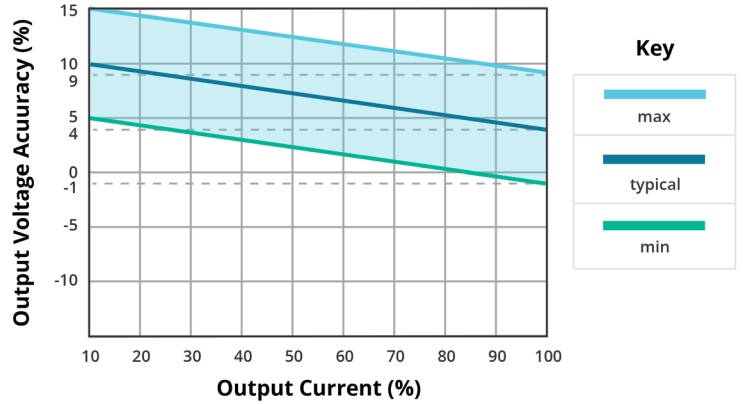

OUTPUT REGULATION CURVE
VQA3S-S15-D15-S
(+Vo)

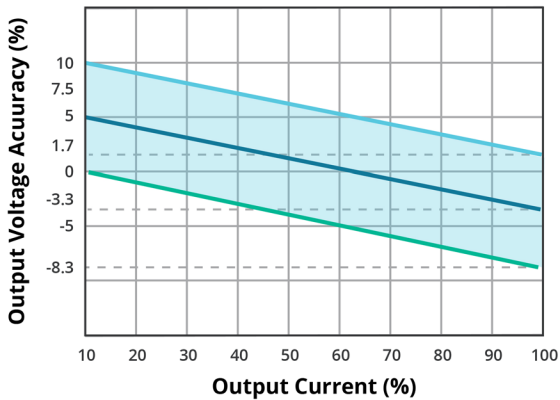

OUTPUT REGULATION CURVE
VQA3S-S15-D15-S
(-Vo)

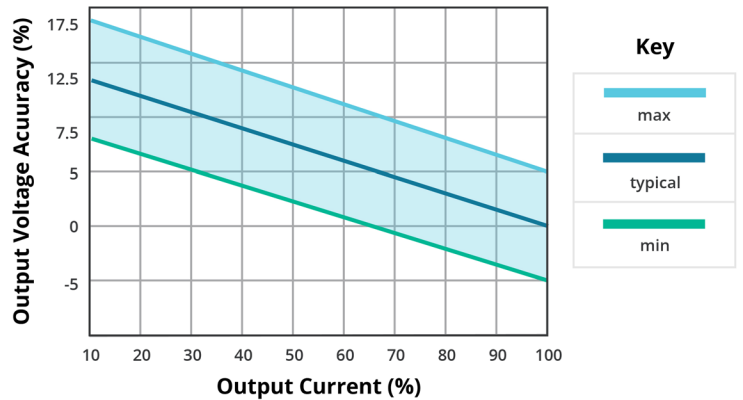

OUTPUT REGULATION CURVE
VQA3S-S15-D20-S
(+Vo)

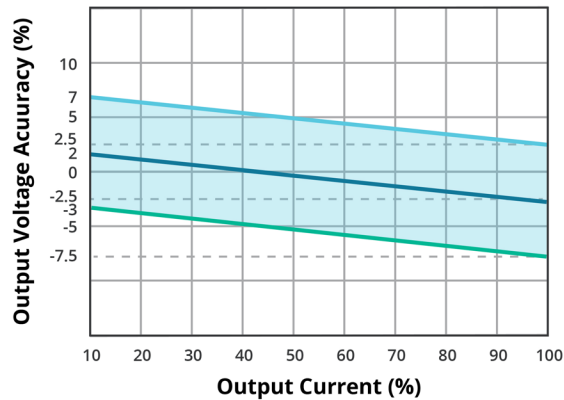

OUTPUT REGULATION CURVE
VQA3S-S15-D20-S
(-Vo)

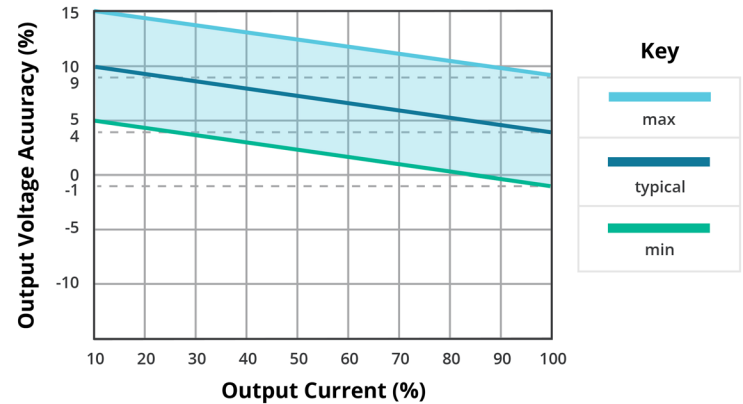

REGULATION CURVES (CONTINUED)

**OUTPUT REGULATION CURVE
VQA3S-S24-D15-S
(+Vo)**

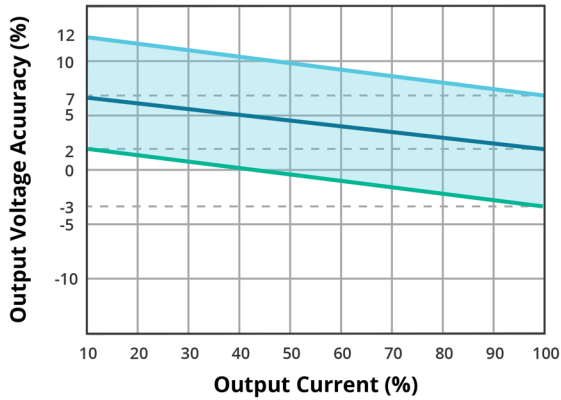

**OUTPUT REGULATION CURVE
VQA3S-S24-D15-S
(-Vo)**

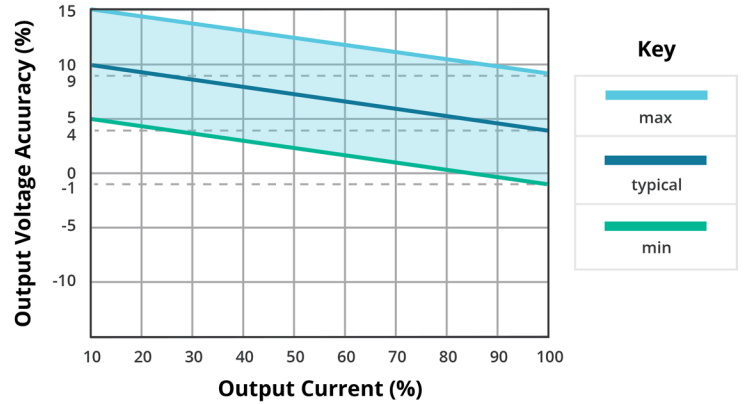

**OUTPUT REGULATION CURVE
VQA3S-S24-D20-S
(+Vo)**

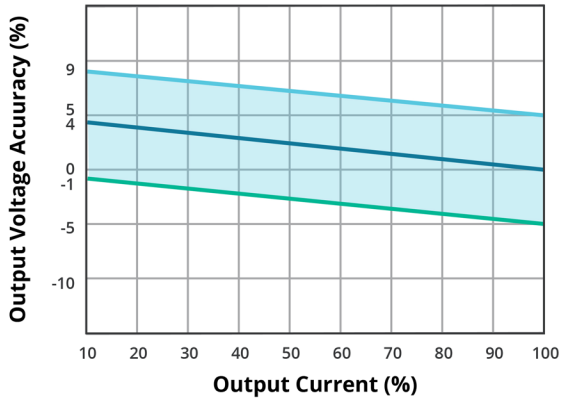

**OUTPUT REGULATION CURVE
VQA3S-S24-D20-S
(-Vo)**

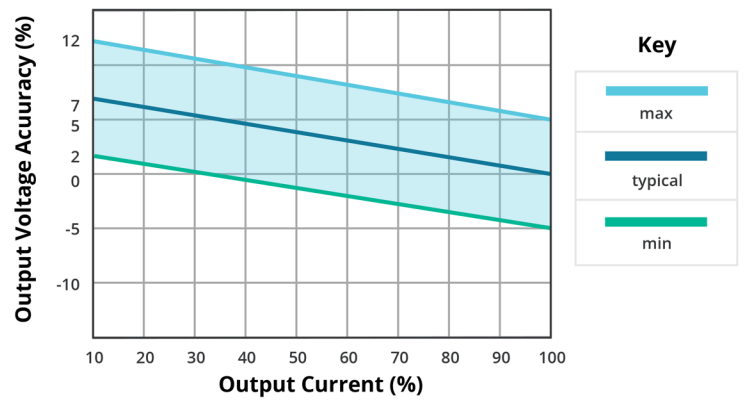

EFFICIENCY CURVES

EFFICIENCY VS INPUT VOLTAGE
(full load)

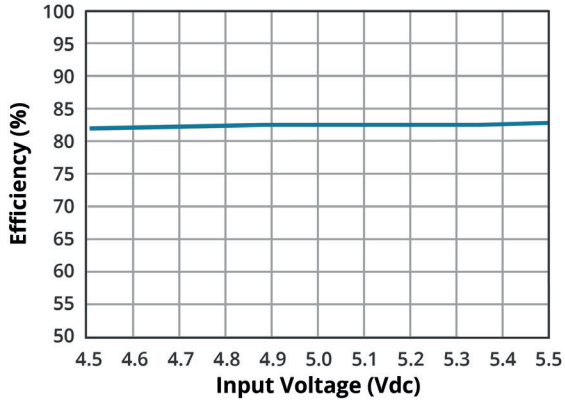

EFFICIENCY VS OUTPUT LOAD
($V_{in} = V_{in-nominal}$)

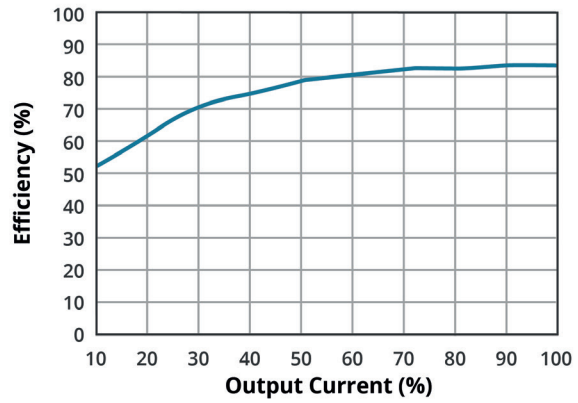

EFFICIENCY VS INPUT VOLTAGE
(full load)

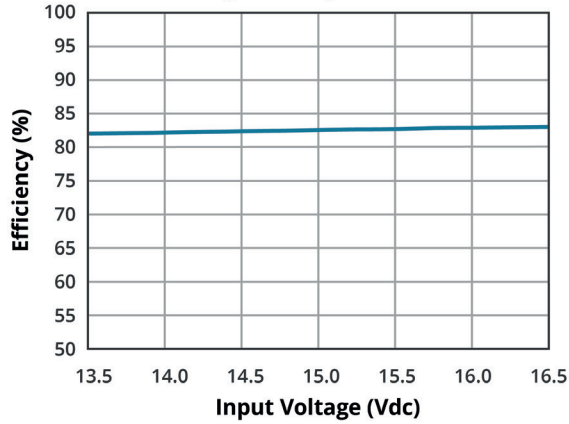

EFFICIENCY VS OUTPUT LOAD
($V_{in} = 15\text{ Vdc}$)

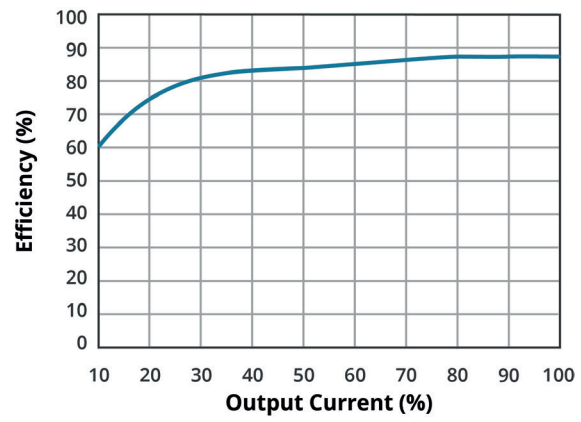

EMC RECOMMENDED CIRCUIT

Figure 1

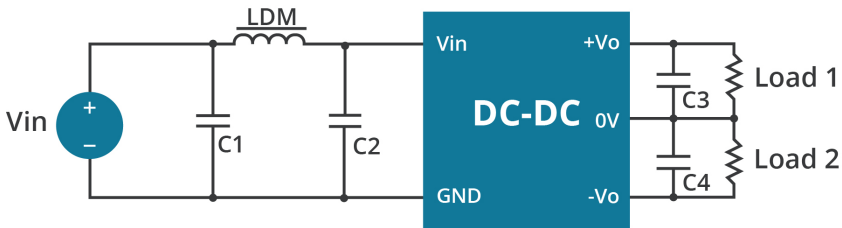

Table 1

Project		5V	12V, 15V, 24V
EMI	C1/C2	4.7μF/16V	1μF/50V
	C3/C4	10μF/50V (low resistance)	100μF/30V (low resistance)
	LDM	6.8μH	33μH

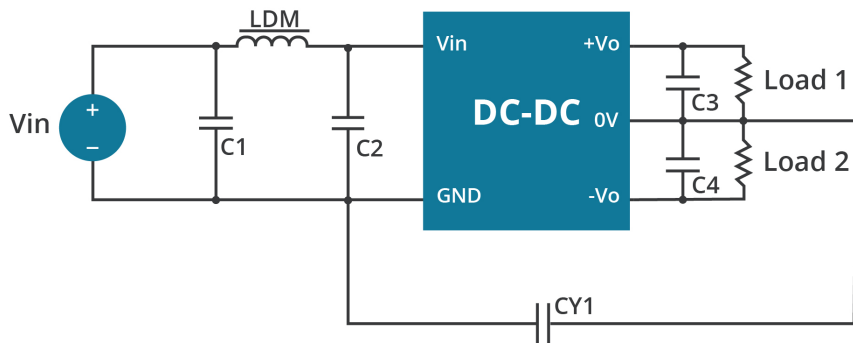
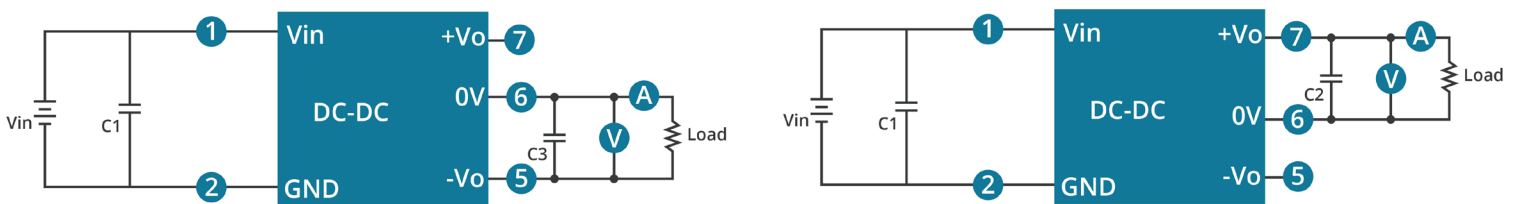

Table 2

Project		5V
EMI	C1/C2	4.7μF/16V
	C3/C4	10μF/50V (low resistance)
	LDM	6.8μH
	CY1	330pF

TEST CONFIGURATION

Figure 2



C1, C2, C3: 100 μF/35V (low internal resistance)

APPLICATION CIRCUIT

Figure 3

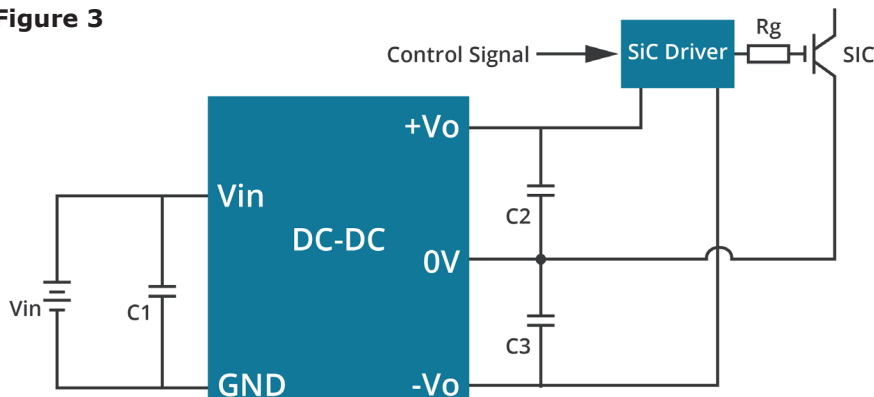

Table 3

C1/C2/C3
100 μ F/35V (low resistance)

MEASURING RIPPLE AND NOISE

Figure 4

Parallel cable measuring method

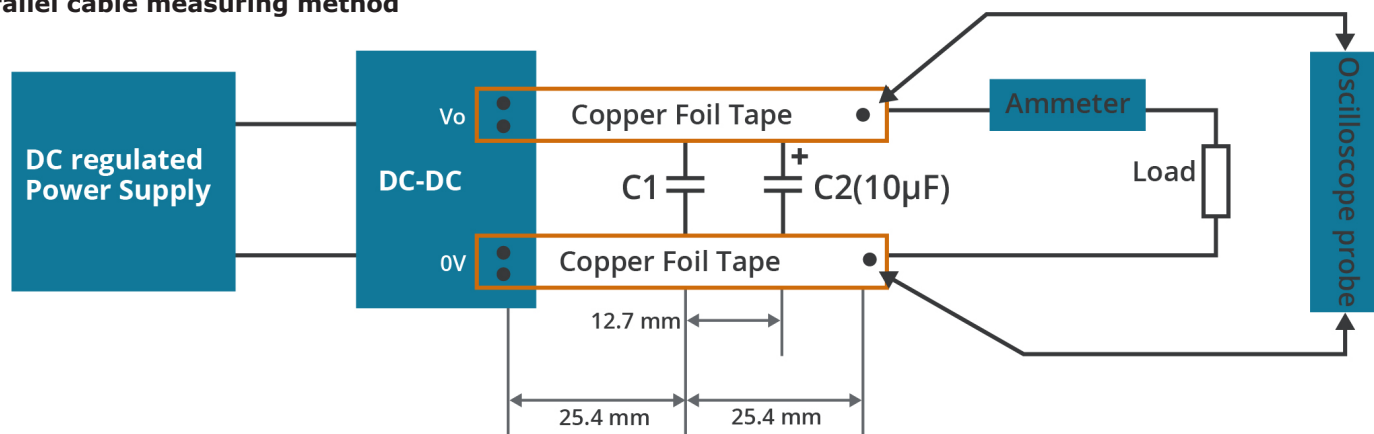

- Notes:
- C1: Ceramic capacitor with 1 μ F capacitance.
 - C2: Capacitor suitable for fixed input products. Please refer to datasheet. Normally 10 μ F is recommended.
 - Distance between two paralleled copper foils is 2.5mm of which the sum of voltage drops should be less than 2% of nominal voltage.

- Notes:
- The lead connecting the power supply module and SiC driver must be as short as possible.
 - The output filtering capacitor should be connected as close as possible to the converter and the SiC driver.
 - The peak of the SiC driver gate drive current is high, so a low internal resistance electrolytic capacitor is recommended to be used for the power supply module output filter capacitor.
 - The average output power of the driver must be lower than that of the power supply module.
 - The maximum capacitive load is tested at nominal input voltage and full load.
 - Consider fixing with glue near the module if being used in a vibration occasion.
 - All specifications are measured at Ta=25°C, humidity <75%, nominal input voltage and rated output load unless otherwise specified.

REVISION HISTORY

rev.	description	date
1.0	initial release	10/11/2022

The revision history provided is for informational purposes only and is believed to be accurate.



CUI INC
a bel group

Headquarters
20050 SW 112th Ave.
Tualatin, OR 97062
800.275.4899

Fax 503.612.2383
cui.com
techsupport@cui.com

CUI offers a two (2) year limited warranty. Complete warranty information is listed on our website.

CUI reserves the right to make changes to the product at any time without notice. Information provided by CUI is believed to be accurate and reliable. However, no responsibility is assumed by CUI for its use, nor for any infringements of patents or other rights of third parties which may result from its use.

CUI products are not authorized or warranted for use as critical components in equipment that requires an extremely high level of reliability. A critical component is any component of a life support device or system whose failure to perform can be reasonably expected to cause the failure of the life support device or system, or to affect its safety or effectiveness.