

**MOLEX P/N:
46562-1013**

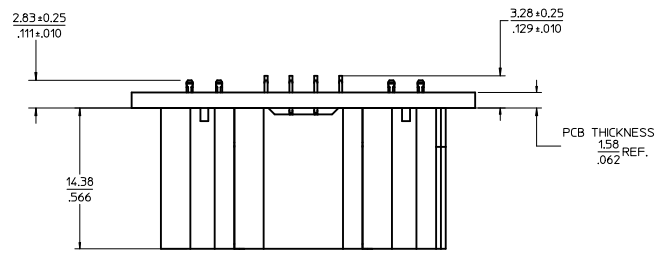

NOTES:

- MATERIAL:**
 - HOUSINGS: LCP UL-94, V-0, COLOR: BLACK.
 - TERMINALS: COPPER ALLOY.
 - PLATING: 0.00127/.000050 NICKEL OVERALL WITH 0.00254/.000100 SELECTIVE TIN ON COMPLIANT TAILS AND 0.000762/.000030 SELECTIVE GOLD ON CONTACT AREA.
- PACKAGING:** ASSEMBLIES TO BE TRAY PACKED PER PACKAGING SPEC PK-46436-xxxx.
- INDIVIDUAL MODULES ARE RATED FOR VARIOUS VOLTAGE AND CURRENT RATINGS PER PS-46436-100.**
- PC BOARD REQUIRES SOLDER THRU HOLES, REFER TO PS-46436-100 FOR DETAILS.**
- PRODUCT TO MEET RoHS REQUIREMENTS.**
- ASSEMBLY MATES TO MOLEX PLUG ASSEMBLY P/N 46437-1013.**

CHNG PLATING SPEC EIC NO. UCFP2012-1534 DRAWN BY BPI/SZCZOR 2011/11/11 CHECKED BY CHYD/APATEL 2011/11/11 APPR: APATEL 2011/11/14 REV DESCRIPTION	QUALITY SYMBOLS		GENERAL TOLERANCES (UNLESS SPECIFIED)		DIMENSION STYLE MM/IN		SCALE 4:1		DESIGN UNITS METRIC		THIRD ANGLE PROJECTION	
	4 PLACES ± --- ± --- 3 PLACES ± --- ± .010 2 PLACES ± 0.25 ± .010 1 PLACE ± 0.25 ± ---		mm INCH		DRAWN BY DATE BPI/SZCZOR 2011/11/11		CHECKED BY DATE APATEL 2011/11/11		APPROVED BY DATE		TITLE RECEPTACLE ASSY TEN50 FAMILY, VERTICAL 1DC, 12S, 1DC	
	ANGULAR ±1/2°		DRAFT WHERE APPLICABLE MUST REMAIN WITHIN DIMENSIONS		MATERIAL NO. 46562-1013		DOCUMENT NO. SD-46562-113		SHEET NO. 1 OF 1		MOLEX INCORPORATED	
	THIS DRAWING CONTAINS INFORMATION THAT IS PROPRIETARY TO MOLEX INCORPORATED AND SHOULD NOT BE USED WITHOUT WRITTEN PERMISSION											

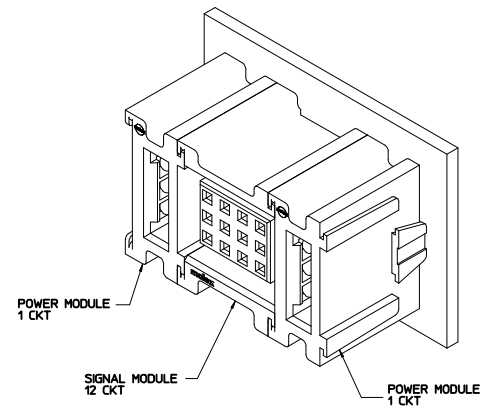
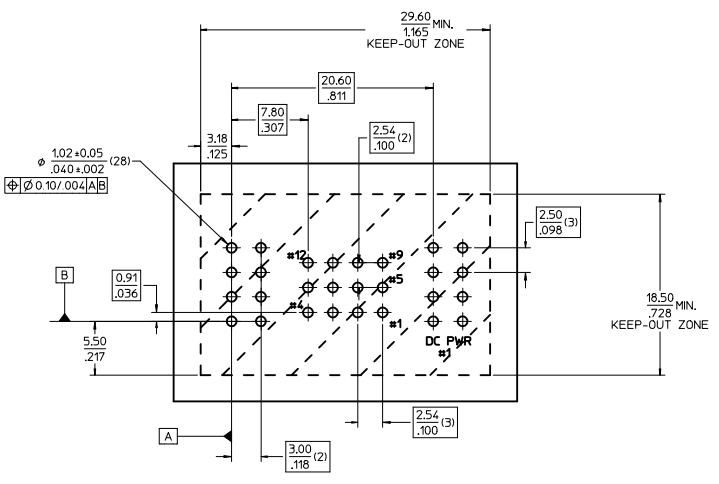
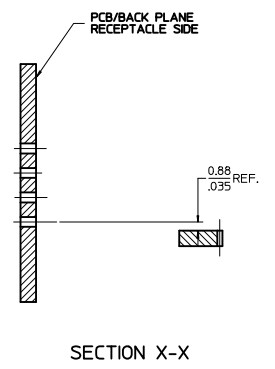
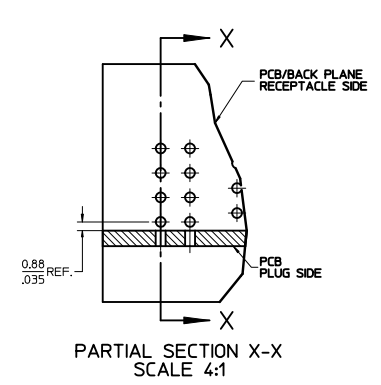
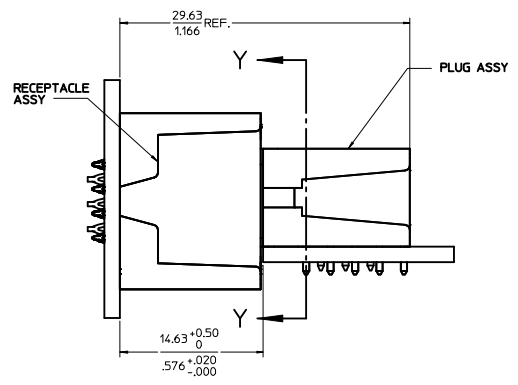
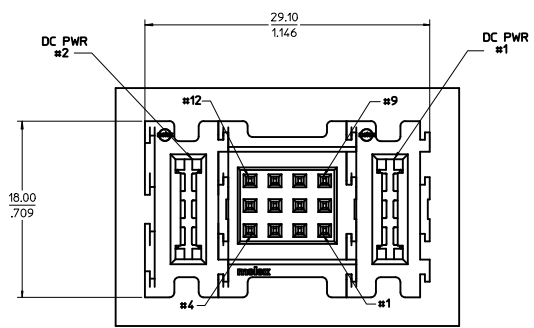

**MOLEX P/N:
46562-1013**

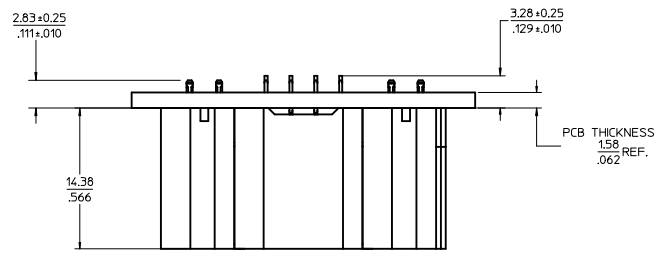

NOTES:

- MATERIAL:**
 - HOUSINGS: LCP UL-94, V-0, COLOR: BLACK.
 - TERMINALS: COPPER ALLOY.
 - PLATING: 0.00127/.000050 NICKEL OVERALL WITH 0.00254/.000100 SELECTIVE TIN ON COMPLIANT TAILS AND 0.000762/.000030 SELECTIVE GOLD ON CONTACT AREA.
- PACKAGING:** ASSEMBLIES TO BE TRAY PACKED PER PACKAGING SPEC PK-46436-xxxx.
- INDIVIDUAL MODULES ARE RATED FOR VARIOUS VOLTAGE AND CURRENT RATINGS PER PS-46436-100.**
- PC BOARD REQUIRES SOLDER THRU HOLES, REFER TO PS-46436-100 FOR DETAILS.**
- PRODUCT TO MEET RoHS REQUIREMENTS.**
- ASSEMBLY MATES TO MOLEX PLUG ASSEMBLY P/N 46437-1013.**

CHNG PLATING SPEC EIC NO. UCFP2012-1534 DRAWN BY BPI/SZCZOR 2011/11/11 CHECKED BY CHYD/APATEL 2011/11/11 APPR: APATEL 2011/11/14	QUALITY SYMBOLS	GENERAL TOLERANCES (UNLESS SPECIFIED)	DIMENSION STYLE MM/IN	SCALE 4:1	DESIGN UNITS METRIC	THIRD ANGLE PROJECTION
		4 PLACES ± --- ± ---	DRAWN BY DATE BPI/SZCZOR 2011/11/11	TITLE RECEPTACLE ASSY TEN50 FAMILY, VERTICAL 1DC, 12S, 1DC		
		3 PLACES ± --- ± .010	CHECKED BY DATE APATEL 2011/11/11	MATERIAL NO. 46562-1013		
		2 PLACES ± 0.25 ± .010	APPROVED BY DATE	DOCUMENT NO. SD-46562-113		
	1 PLACE ± 0.25 ± ---	ANGULAR ±1/2°	MOLEX MOLEX INCORPORATED			SHEET NO. 1 OF 1
	DRAFT WHERE APPLICABLE MUST REMAIN WITHIN DIMENSIONS		THIS DRAWING CONTAINS INFORMATION THAT IS PROPRIETARY TO MOLEX INCORPORATED AND SHOULD NOT BE USED WITHOUT WRITTEN PERMISSION			