

Printed-circuit board connector - SPC 16/ 4-STF-10,16 - 1711394

Please be informed that the data shown in this PDF Document is generated from our Online Catalog. Please find the complete data in the user's documentation. Our General Terms of Use for Downloads are valid (<http://phoenixcontact.com/download>)

PCB connector, nominal current: 76 A, number of positions: 4, pitch: 10.16 mm, connection method: Push-in spring connection, color: green, contact surface: Silver



The figure shows a 5-pos. version of the product

Your advantages

- Time saving push-in connection, tools not required
- Defined contact force ensures that contact remains stable over the long term
- Clamping space opened by means of fixed screwdriver enables convenient conductor connection
- Integrated double steel spring provides additional safety in the event of temperature and power fluctuations
- Optimized for tight installation situations: operation and conductor connection from one direction
- Screwable flange for superior mechanical stability

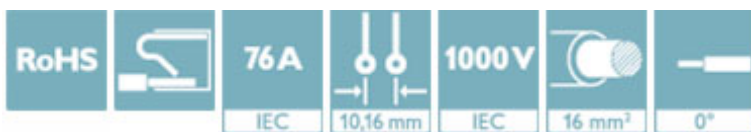

Key Commercial Data

Packing unit	50 pc
GTIN	 4 046356 081146
GTIN	4046356081146

Technical data

Dimensions

Length [l]	44.5 mm
Width [w]	58.4 mm
Height [h]	25.1 mm
Pitch	10.16 mm
Dimension a	30.48 mm

General

Range of articles	SPC 16/..-STF
Number of positions	4
Connection method	Push-in spring connection

Printed-circuit board connector - SPC 16/ 4-STF-10,16 - 1711394

Technical data

General

Insulating material group	I
Rated surge voltage (III/3)	8 kV
Rated surge voltage (III/2)	8 kV
Rated surge voltage (II/2)	6 kV
Rated voltage (III/3)	1000 V
Rated voltage (III/2)	1000 V
Rated voltage (II/2)	1000 V
Connection in acc. with standard	EN-VDE
Nominal current I _N	76 A
Nominal cross section	16 mm ²
Maximum load current	76 A
Insulating material	PA
Flammability rating according to UL 94	V0
Stripping length	18 mm

Connection data

Conductor cross section solid min.	0.75 mm ²
Conductor cross section solid max.	16 mm ²
Conductor cross section flexible min.	0.75 mm ²
Conductor cross section flexible max.	16 mm ²
Conductor cross section flexible, with ferrule without plastic sleeve min.	0.75 mm ²
Conductor cross section flexible, with ferrule without plastic sleeve max.	16 mm ²
Conductor cross section flexible, with ferrule with plastic sleeve min.	0.75 mm ²
Conductor cross section flexible, with ferrule with plastic sleeve max.	10 mm ²
Conductor cross section AWG min.	18
Conductor cross section AWG max.	4
2 conductors with same cross section, stranded, TWIN ferrules with plastic sleeve, min.	0.75 mm ²
2 conductors with same cross section, stranded, TWIN ferrules with plastic sleeve, max.	4 mm ²
Minimum AWG according to UL/CUL	20
Maximum AWG according to UL/CUL	4

Standards and Regulations

Connection in acc. with standard	EN-VDE
	CUL
Flammability rating according to UL 94	V0

Environmental Product Compliance

China RoHS	Environmentally friendly use period: unlimited = EFUP-e
	No hazardous substances above threshold values

Drawings

Printed-circuit board connector - SPC 16/ 4-STF-10,16 - 1711394

Diagram

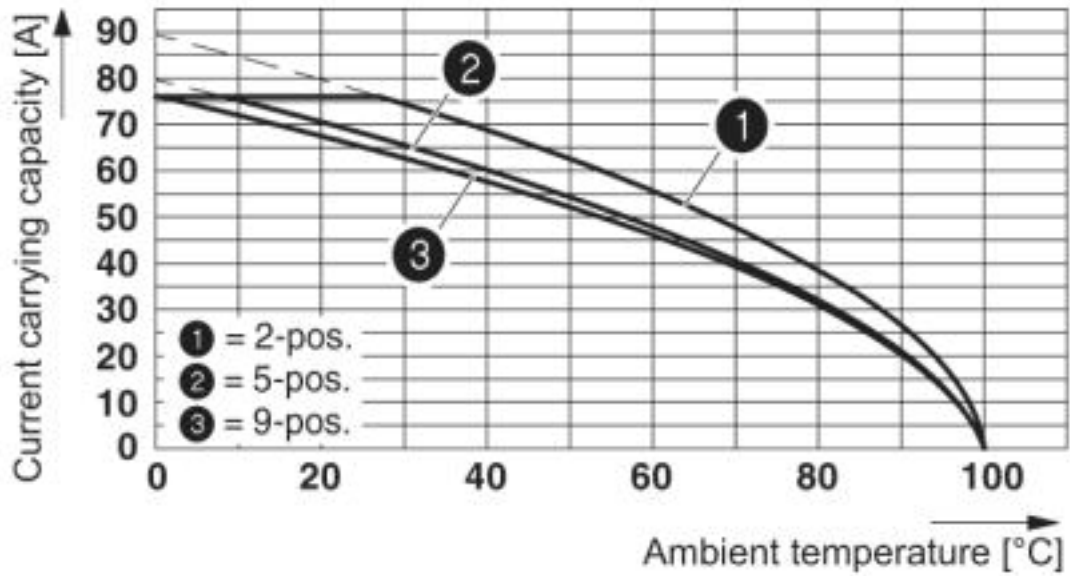

Type: SPC 16/...-ST-10,16 with PC 6-16/...-G1-10,16

Diagram

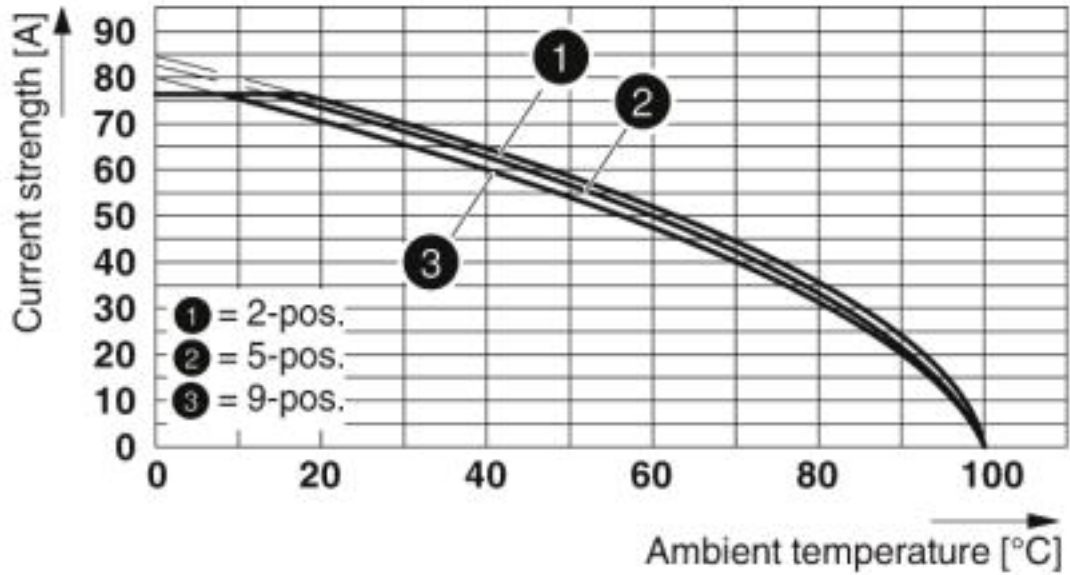

Type: SPC 16/...-ST(F)-10,16 with DFK-PC 16/...-ST(F)-10,16

Printed-circuit board connector - SPC 16/ 4-STF-10,16 - 1711394

Dimensional drawing

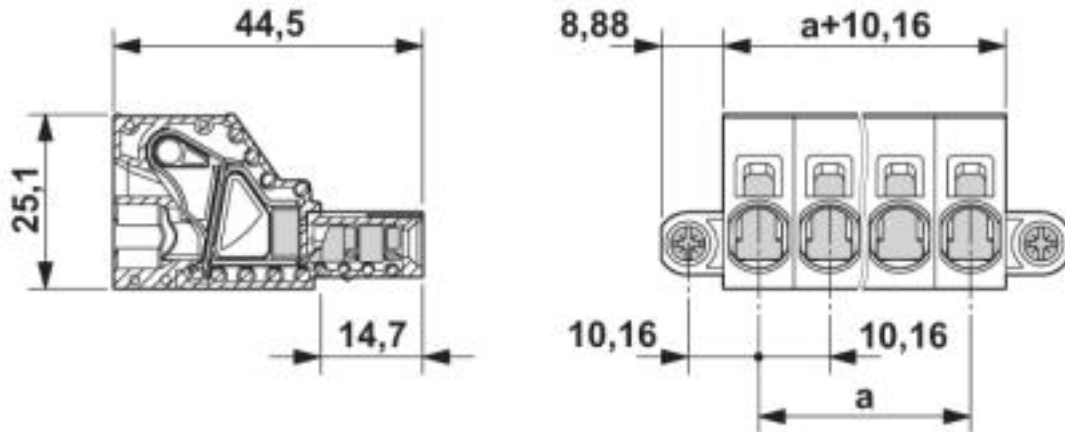

Approvals

Approvals

Approvals

IECEE CB Scheme / SEV / EAC / cULus Recognized

Ex Approvals

Approval details

IECEE CB Scheme		http://www.iecee.org/	CH-8077
Nominal voltage UN	1000 V		
Nominal current IN	76 A		

SEV		https://www.electrosuisse.ch/de/meta/shop/produktezertifikate.html	IK-3431
Nominal voltage UN	1000 V		
Nominal current IN	76 A		
mm ² /AWG/kcmil	16		

Printed-circuit board connector - SPC 16/ 4-STF-10,16 - 1711394

Approvals

EAC		B.01742
-----	---	---------

cULus Recognized		http://database.ul.com/cgi-bin/XYV/template/LISEXT/1FRAME/index.htm	E60425-20040202
	B	C	
Nominal voltage UN	600 V	600 V	
Nominal current IN	66 A	66 A	
mm ² /AWG/kcmil	20-4	20-4	

Phoenix Contact 2019 © - all rights reserved
<http://www.phoenixcontact.com>

PHOENIX CONTACT GmbH & Co. KG
Flachsmarktstr. 8
32825 Blomberg
Germany
Tel. +49 5235 300
Fax +49 5235 3 41200
<http://www.phoenixcontact.com>