



SPECIFICATION SHEET

SPECIFICATION SHEET NO.	N0929-DO271N5404A340
DATE	Sept. 29, 2021
REVISION	A0
DESCRIPTION	<p>Axial Lead General Purpose Silicon Rectifier, DO-27/DO-201AD series, 1N5404 Type 2 Pins</p> <p>Reverse Voltage 400V Max. Forward Current 3.0A Max.</p> <p>Operating Temp. Range -65°C ~+150°C</p> <p>Package in AMMO Pack, 1000pcs/Tape, Tape/Box</p> <p>RoHS/RoHS III compliant</p>
CUSTOMER	
CUSTOMER PART NUMBER	
CROSS REF. PART NUMBER	
ORIGINAL PART NUMBER	MDD 1N5404
PART CODE	DO271N5404A340

VENDOR APPROVE			
Issued/Checked/Approved			
DATE: Sept. 29, 2021			

CUSTOMER APPROVE	
DATE:	

GENERAL PURPOSE SILICON RECTIFIER DO-27 SERIES



MAIN FEATURE

- The plastic package carries Underwriters Laboratory Flammability Classification 94V-0
- Fast switching for high efficiency
- High forward surge current capability
- High temperature soldering guaranteed, 250 °C/10 seconds at terminals
- Low reverse leakage
- Construction utilizes void free molded plastic technique

APPLICATION

- For printed circuit board

RFQ

[Request For Quotation](#)

PART CODE GUIDE

DO27	1N5404	A	340
1	2	3	4

- 1) **DO27**: Axial Lead General Purpose Silicon Rectifier, 2 Pins, DO-27/DO-201AD series
- 2) **1N5404**: Type Code for original part number 1N5404
- 3) **A**: Package code, Package in AMMO Pack, 1000pcs/Tape, Tape/Box
- 4) **340** Specification code for Forward Current 3.0A Max. Reverse Voltage 400V Max.

MORE ITEMS AVAILABLE

DO271N5400A305	DO271N5401A310	DO271N5402A320	DO271N5403A330	DO271N5404A340
DO271N5405A350	DO271N5406A360	DO271N5407A380	DO271N5408A30A	

GENERAL PURPOSE SILICON RECTIFIER DO-27 SERIES

DIMENSION (Unit: Inch/mm)

Image for reference



Marking: 1N5404

DO-27/DO-201AD

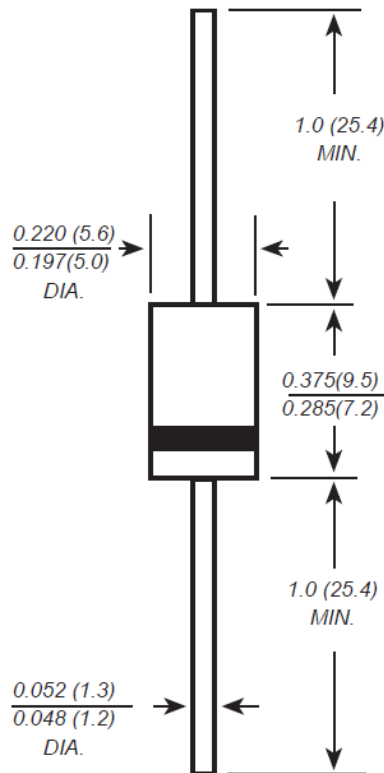

GENERAL PURPOSE SILICON RECTIFIER DO-27 SERIES
MECHANICAL DATA

Case	Terminals	Polarity	Mounting Position	Weight per piece
JEDEC DO-27/DO-201AD molded plastic body	Solder plated, Solderable per MIL-STD-750, Method 2026	Polarity symbol marking on case	Any	0.04 Ounce, 1.1 grams

MAX. RATING & CHARACTERISTICS

Parameter	SYMBOLS	VALUE			UNITS
		Min.	Typical	Max.	
Repetitive peak reverse voltage	V _{RRM}			400	Volts
RMS voltage	V _{RMS}			280	Volts
DC blocking voltage	V _{DC}			400	Volts
Average forward output rectified current at TL= 75°C	I _{AV}			3.0	A
Peak forward surge current 8.3ms single half sine-wave superimposed on rated load (JEDEC Method)	I _{FSM}			150.0	A
Instantaneous forward voltage at 3.0A	V _F			1.2	Volts
DC reverse current at rated DC blocking voltage	I _R			5.0	μA
				100	μA
Junction capacitance (Note 2)	C _J		30		pF
Thermal resistance (Note 3)	R _{QJA}		20		°C/W
Operating junction temperature range	T _J	-65		+150	°C
Storage temperature range	T _{STG}	-65		+150	°C

Note

- Ratings at 25 C ambient temperature unless otherwise specified. Single phase half-wave 60Hz, resistive or inductive load, for capacitive load current derate by 20%.
- Measured at 1.0MHz and applied reverse voltage of 4.0Voltage
- Thermal resistance from junction to ambient at 0.375"(9.5mm)lead length, PCB. Mounted.

GENERAL PURPOSE SILICON RECTIFIER DO-27 SERIES

RELIABILITY

Number	Experiment Items	Experiment Method And Conditions	Reference Documents
1	Solder Resistance Test	Test 260°C± 5°C for 10 ± 2 sec. Immerse body into solder 1/16" ± 1/32"	MIL-STD-750D METHOD-2031.2
2	Solderability Test	230°C ±5°C for 5 sec.	MIL-STD-750D METHOD-2026.1 0
3	Pull Test	1 kg in axial lead direction for 10 sec.	MIL-STD-750D METHOD-2036.4
4	Bend Test	0.5Kg Weight Applied To Each Lead, Bending Arcs 90 °C ± 5 °C For 3 Times	MIL-STD-750D METHOD-2036.4
5	High Temperature Reverse Bias Test	TA=100°C for 1000 Hours at VR=80% Rated VR	MIL-STD-750D METHOD-1038.4
6	Forward Operation Life Test	TA=25°C Rated Average Rectified Current	MIL-STD-750D METHOD-1027.3
7	Intermittent Operation Life Test	On state: 5 min with rated IRMS Power Off state: 5 min with Cool Forced Air. On and off for 1000 cycles.	MIL-STD-750D METHOD-1036.3
8	Pressure Cooker Test	15 PSIG, TA=121°C, 4 hours	MIL-S-19500 APPENOIXC
9	Temperature Cycling Test	-55°C~+125°C; 30 Minutes For Dwelled Time 5 minutes for transferred time. Total: 10 cycles.	MIL-STD-750D METHOD-1051.7
10	Thermal Shock Test	0°C for 5 minutes., 100°C for 5minutes, Total: 10 cycles	MIL-STD-750D METHOD-1056.7
11	Forward Surge Test	8.3ms Single Sale Sine-wave One Surge.	MIL-STD-750D METHOD-4066.4
12	Humidity Test	TA=65°C, RH=98% for 1000 hours.	MIL-STD-750D METHOD-1021.3
13	High Temperature Storage life Test	150°C for 1000 Hours	MIL-STD-750D METHOD-1031.5

GENERAL PURPOSE SILICON RECTIFIER DO-27 SERIES

RATINGS AND CHARACTERISTIC CURVES (For Reference Only)

AVERAGE FORWARD RECTIFIED CURRENT, AMPERES

FIG. 1- FORWARD CURRENT DERATING CURVE

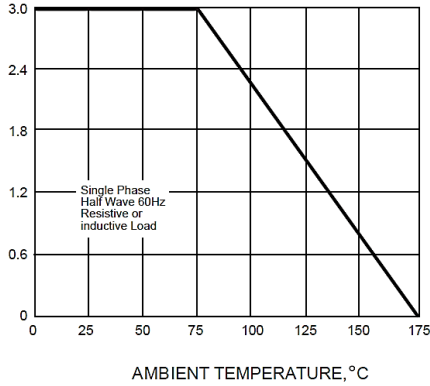

PEAK FORWARD SURGE CURRENT, AMPERES

FIG. 2-MAXIMUM NON-REPETITIVE PEAK FORWARD SURGE CURRENT

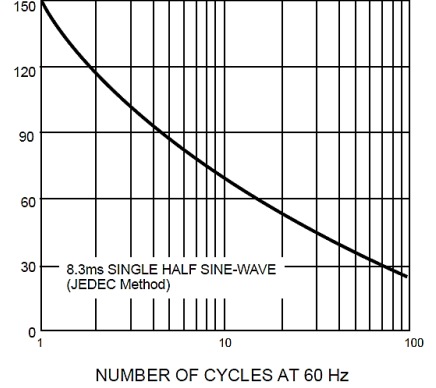

INSTANTANEOUS FORWARD CURRENT, AMPERES

FIG. 3-TYPICAL INSTANTANEOUS FORWARD CHARACTERISTICS

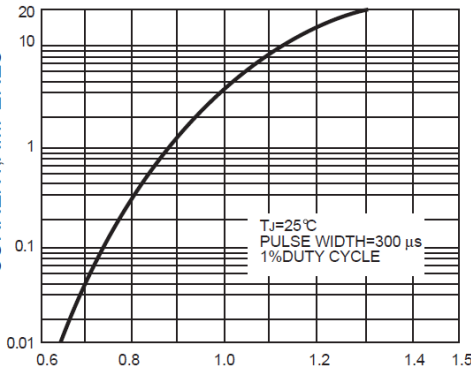

INSTANTANEOUS REVERSE CURRENT, MICROAMPERES

FIG. 4-TYPICAL REVERSE CHARACTERISTICS

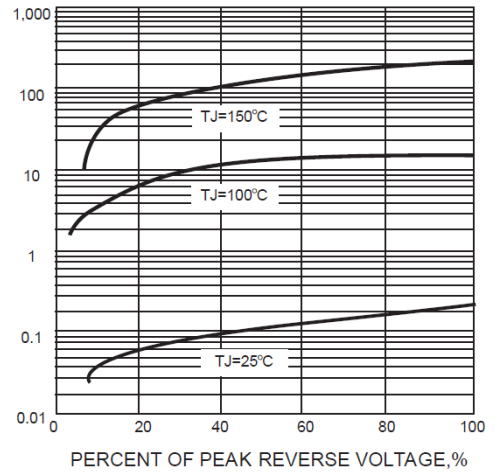

JUNCTION CAPACITANCE, pF

FIG. 5-TYPICAL JUNCTION CAPACITANCE

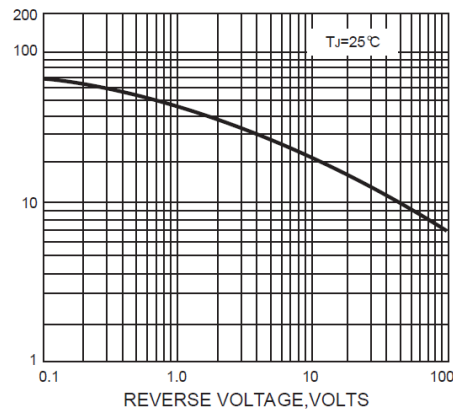

TRANSIENT THERMAL IMPEDANCE, °C/W

FIG. 6-TYPICAL TRANSIENT THERMAL IMPEDANCE

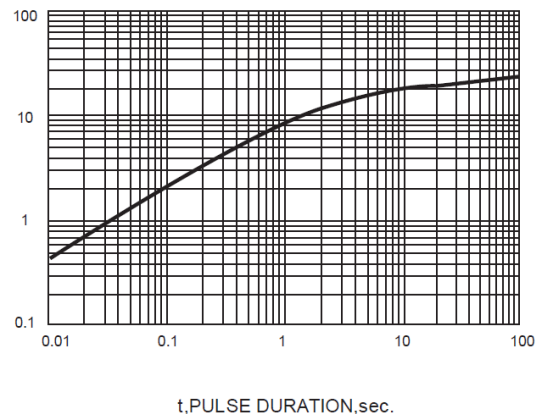

GENERAL PURPOSE SILICON RECTIFIER DO-27 SERIES

AMMO BOX (Unit: mm)

- All Devices are packed in accordance with EIA standard RS-296-D and specifications.
- Each component lead shall be sandwiched between taps for A minimum of 3.2 mm (0.126")

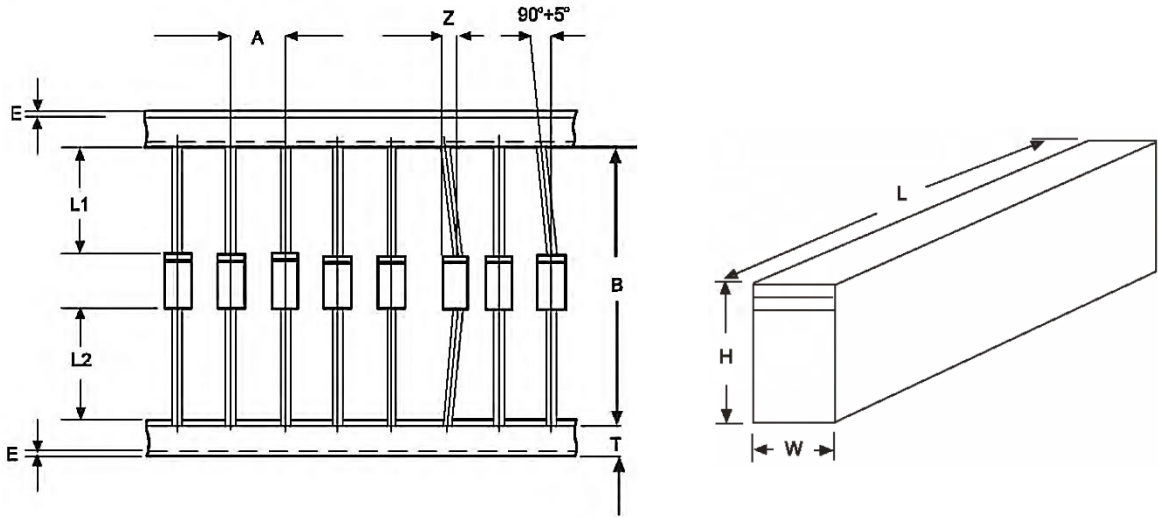

Item	Symbol	DO-27/DO-201AD Uni(mm)	DO-27/DO-201AD Unit (Inch)
Component Alignment	Z	1.2 Max.	0.048 Max.
Tape Width	T	6.0 +/- 0.4	0.236 +/- 0.016
Exposed Adhesive	E	0.8 Max.	0.032 Max.
Body Eccentricity	L1 – L2	1.0 Max.	0.040 Max.
Component Pitch A (2.0mm/10 pitch)	A	10.0	0.197
Component Pitch B (2.0mm/10 pitch)	B	52.4	1.023
Component Pitch A (2.0mm/20 pitch)	-	-	-
Component Pitch B (2.0mm/20 pitch)	-	-	-
Box Length	L	450.0 +/- 5.0	17.72 +/- 0.197
Box Width	W	215.0 +/- 5.0	8.46 +/- 0.197
Box Height	H	250.0 +/- 5.0	9.84 +/- 0.197

GENERAL PURPOSE SILICON RECTIFIER DO-27 SERIES

AMMO PACK IN TAPE/BOX (Unit: mm)

Case Code	Qty. Per Reel (pcs)	Component Space (mm)	Tape Space (mm)	Inner Box L*W*H (mm)	Carton size L*W*H (mm)	Qty. Per Carton (pcs)	G. W (kg)
DO-27/ DO-201AD	1000	10	52.4	260*150*80	470*270*320	10,000	11.4

DISCLAIMER

NextGen Component, Inc. reserves the right to make changes to the product(s) and or information contained herein without notice. No liability is assumed as a result of their use or application. No rights under any patent accompany the sale of any such product(s) or information