

HEIDI-RS

~8° spot beam

SPECIFICATION:

Dimensions	Ø 21.6 mm
Height	11.7 mm
Fastening	tape, pin
ROHS compliant	yes ⓘ

MATERIALS:

Component	Type	Material	Colour	Finish
HEIDI-RS	Single lens	PMMA	clear	
HEIDI-TAPE	Tape	Acrylic foam	black	

ORDERING INFORMATION:

Component		Qty in box	MOQ	MPQ	Box weight (kg)
CA11663_HEIDI-RS	Single lens	3264	204	204	10.4
» Box size: 480 x 280 x 300 mm					



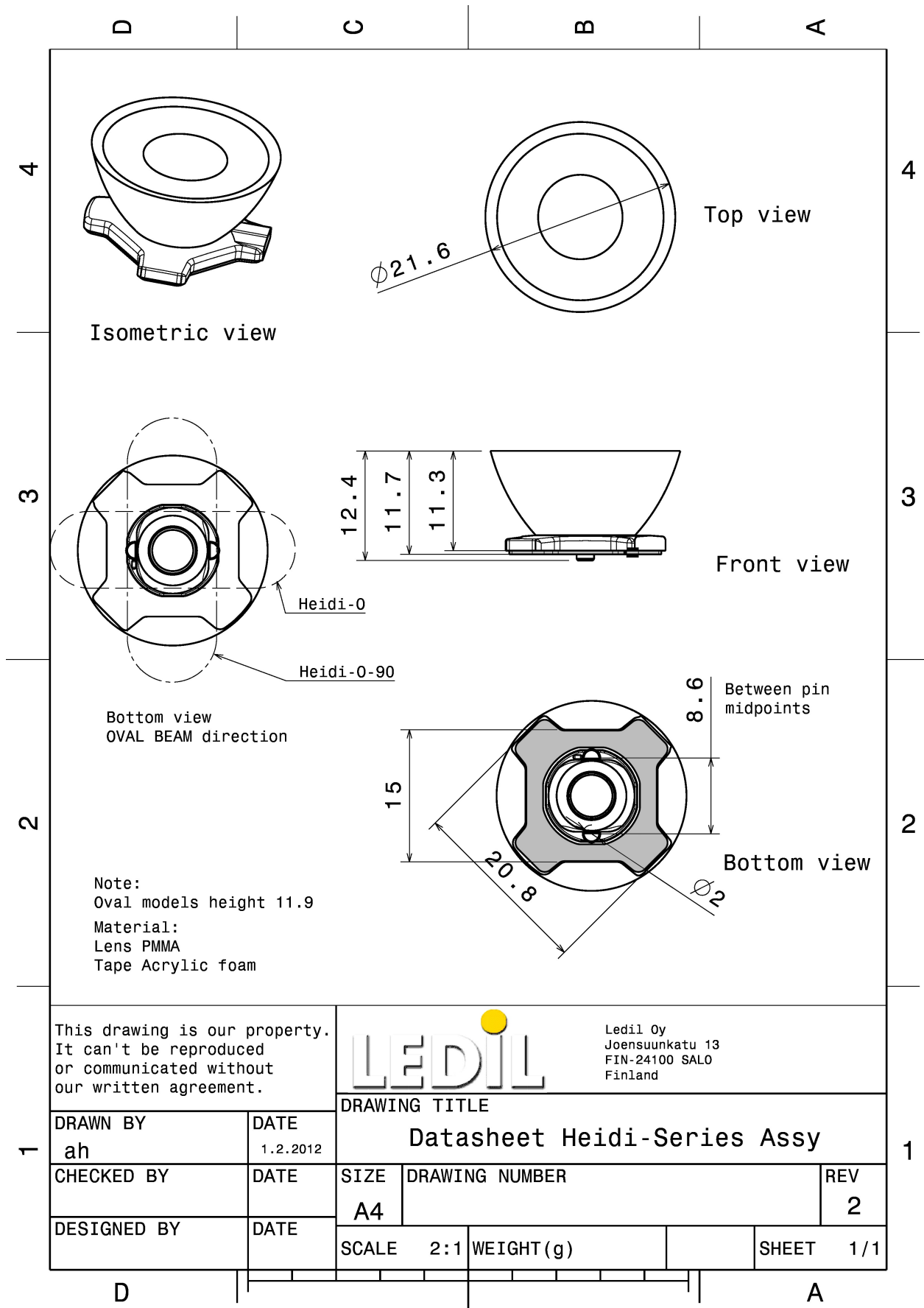

See also our general installation guide: www.ledil.com/installation_guide

OPTICAL RESULTS (MEASURED):

CREE LED

LED XB-D
 FWHM / FWTM 8.0°
 Efficiency 91 %
 Peak intensity 19.7 cd/lm
 LEDs/each optic 1
 Light colour White
 Required components:

CREE LED

LED XB-H
 FWHM / FWTM 10.0° / 19.0°
 Efficiency 90 %
 Peak intensity 18.3 cd/lm
 LEDs/each optic 1
 Light colour White
 Required components:



CREE LED

LED XP-E
 FWHM / FWTM 8.0° / 18.0°
 Efficiency 93 %
 Peak intensity 26.8 cd/lm
 LEDs/each optic 1
 Light colour White
 Required components:

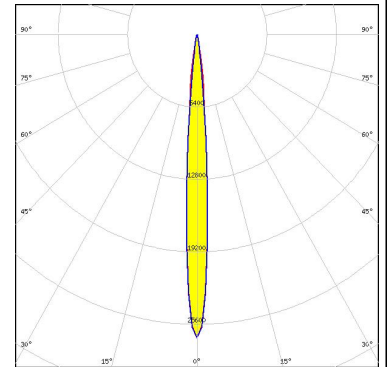

CREE LED

LED XP-E2
 FWHM / FWTM 8.0° / 14.0°
 Efficiency 90 %
 Peak intensity 38 cd/lm
 LEDs/each optic 1
 Light colour White
 Required components:

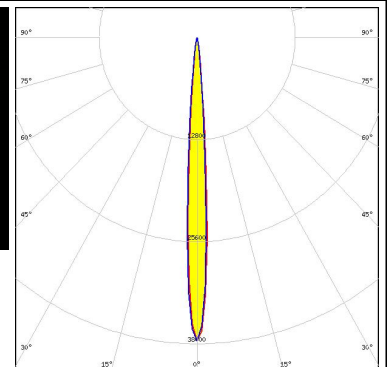

OPTICAL RESULTS (MEASURED):

CREE LED

LED XP-G
 FWHM / FWTM 9.0° / 20.0°
 Efficiency 93 %
 Peak intensity 16.6 cd/lm
 LEDs/each optic 1
 Light colour White
 Required components:

CREE LED

LED XP-G2
 FWHM / FWTM 11.0° / 20.0°
 Efficiency 91 %
 Peak intensity 19.1 cd/lm
 LEDs/each optic 1
 Light colour White
 Required components:

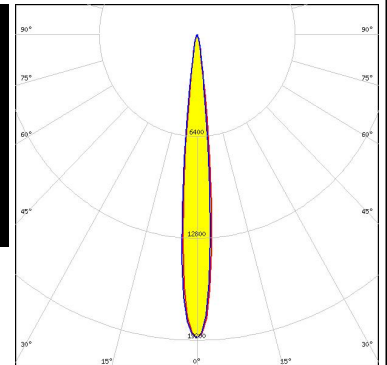

CREE LED

LED XQ-E HD
 FWHM / FWTM 6.0° / 12.0°
 Efficiency 94 %
 Peak intensity 42.1 cd/lm
 LEDs/each optic 1
 Light colour White
 Required components:

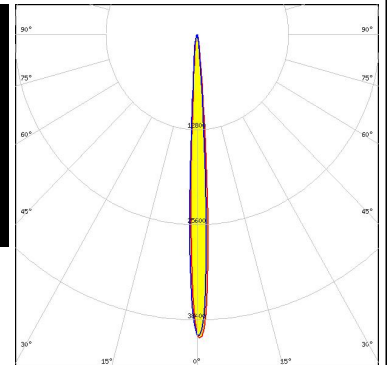

CREE LED

LED XQ-E HI
 FWHM / FWTM 5.0° / 11.0°
 Efficiency 94 %
 Peak intensity 55.2 cd/lm
 LEDs/each optic 1
 Light colour White
 Required components:

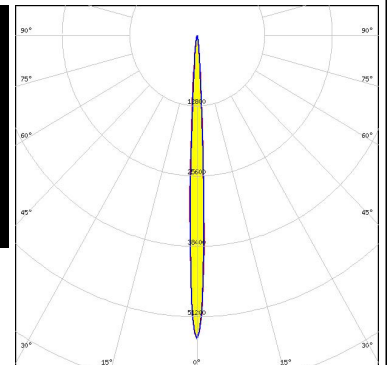
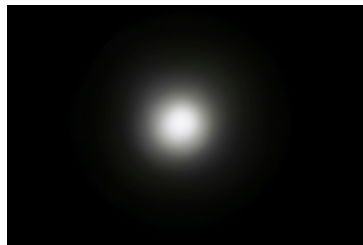

OPTICAL RESULTS (MEASURED):



LED XT-E
 FWHM / FWTM 10.0° / 21.0°
 Efficiency 97 %
 Peak intensity 17.2 cd/lm
 LEDs/each optic 1
 Light colour White
 Required components:

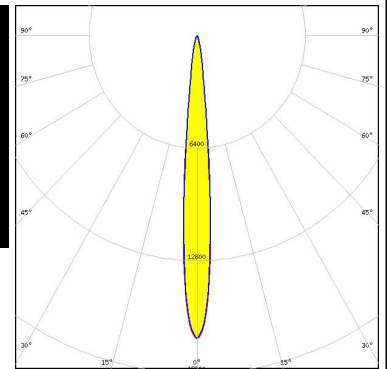

LED LUXEON C
 FWHM / FWTM 7.0° / 14.0°
 Efficiency 92 %
 Peak intensity 35.6 cd/lm
 LEDs/each optic 1
 Light colour White
 Required components:

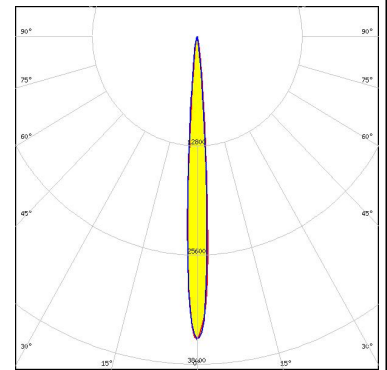

LED LUXEON T
 FWHM / FWTM 11.0° / 20.0°
 Efficiency 92 %
 Peak intensity 16.3 cd/lm
 LEDs/each optic 1
 Light colour White
 Required components:

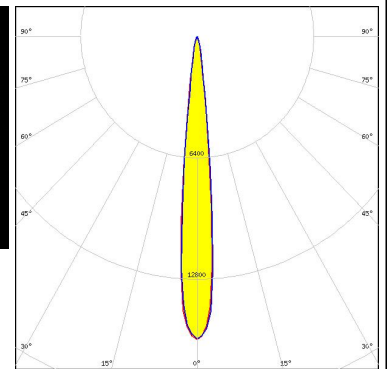

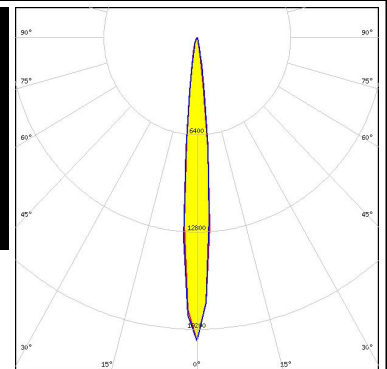

LED LUXEON TX
 FWHM / FWTM 10.0° / 20.0°
 Efficiency 90 %
 Peak intensity 19.5 cd/lm
 LEDs/each optic 1
 Light colour White
 Required components:

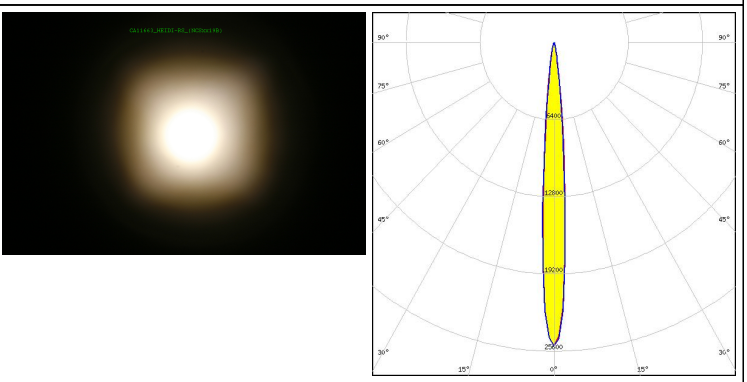
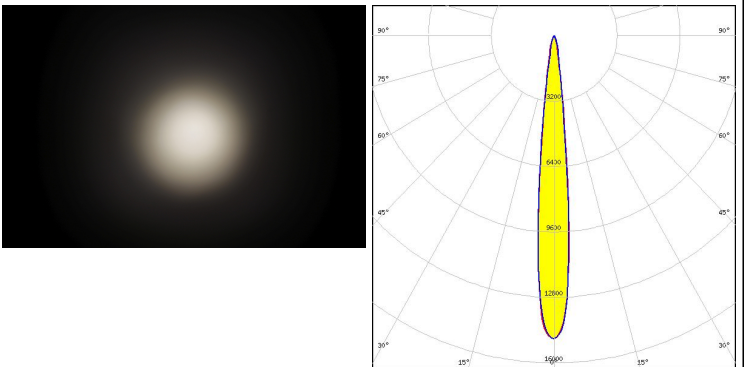

OPTICAL RESULTS (MEASURED):

<p>NICHIA</p> <p>LED NCSxx19A FWHM / FWTM 8.0° / 18.0° Efficiency 89 % Peak intensity 19 cd/lm LEDs/each optic 1 Light colour White Required components:</p>	
<p>NICHIA</p> <p>LED NCSxx19B FWHM / FWTM 9.0° / 18.0° Efficiency 90 % Peak intensity 25.2 cd/lm LEDs/each optic 1 Light colour White Required components:</p>	
<p>NICHIA</p> <p>LED NVSxx19A FWHM / FWTM 10.0° / 23.0° Efficiency 89 % Peak intensity 13.9 cd/lm LEDs/each optic 1 Light colour White Required components:</p>	
<p>NICHIA</p> <p>LED NVSxx19B/NVSxx19C FWHM / FWTM 12.0° / 21.0° Efficiency 96 % Peak intensity 14.8 cd/lm LEDs/each optic 1 Light colour White Required components:</p>	

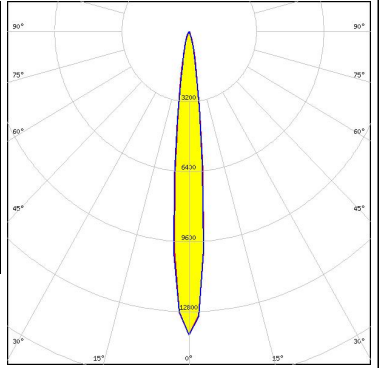
OPTICAL RESULTS (MEASURED):

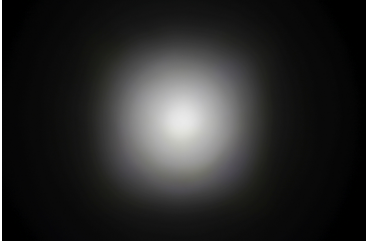
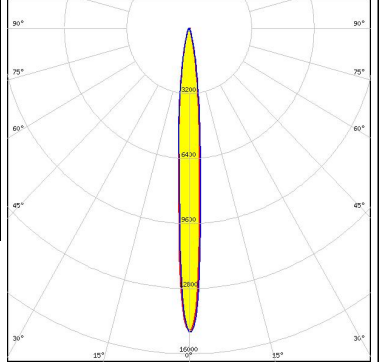
<p>NICHIA</p> <p>LED NVSxx19B/NVSxx19C FWHM / FWTM 12.0° / 26.0° Efficiency 92 % Peak intensity 13.9 cd/lm LEDs/each optic 1 Light colour White Required components:</p>		
<p>OSRAM Opto Semiconductors</p> <p>LED OSLOM Square CSSRM2/CSSRM3 FWHM / FWTM 10.0° / 20.0° Efficiency 89 % Peak intensity 20.8 cd/lm LEDs/each optic 1 Light colour White Required components:</p>		
<p>OSRAM Opto Semiconductors</p> <p>LED OSLOM SSL 150 FWHM / FWTM 7.0° / 16.0° Efficiency 93 % Peak intensity 24.7 cd/lm LEDs/each optic 1 Light colour White Required components:</p>		
<p>SAMSUNG</p> <p>LED LH181A FWHM / FWTM 8.0° / 24.0° Efficiency 94 % Peak intensity 14.9 cd/lm LEDs/each optic 1 Light colour White Required components:</p>		

OPTICAL RESULTS (MEASURED):

SAMSUNG

LED LH181B
 FWHM / FWTM 9.0° / 24.0°
 Efficiency 94 %
 Peak intensity 15 cd/lm
 LEDs/each optic 1
 Light colour White
 Required components:

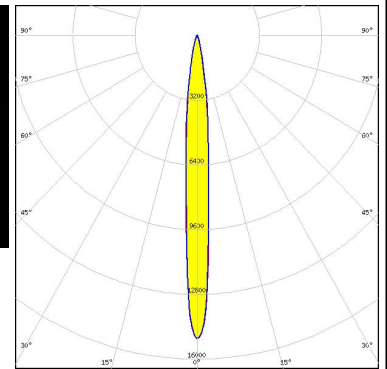

SAMSUNG

LED LH351Z
 FWHM / FWTM 11.0° / 19.0°
 Efficiency 89 %
 Peak intensity 20.7 cd/lm
 LEDs/each optic 1
 Light colour White
 Required components:

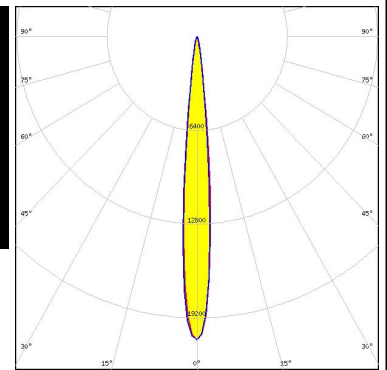

SEOUL SEMICONDUCTOR

LED Z5
 FWHM / FWTM 7.0° / 16.0°
 Efficiency 93 %
 Peak intensity 32.7 cd/lm
 LEDs/each optic 1
 Light colour White
 Required components:



SEOUL SEMICONDUCTOR

LED Z5M1/Z5M2
 FWHM / FWTM 11.0° / 19.0°
 Efficiency 94 %
 Peak intensity 17.8 cd/lm
 LEDs/each optic 1
 Light colour White
 Required components:

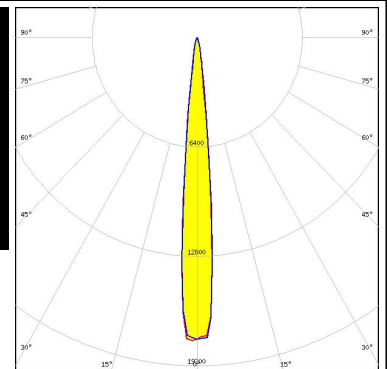
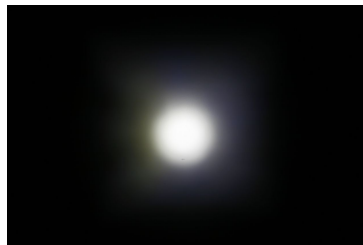

OPTICAL RESULTS (SIMULATED):



LED XHP35.2 HD
 FWHM / FWTM 20.0° / 34.0°
 Efficiency 91 %
 Peak intensity 5.5 cd/lm
 LEDs/each optic 1
 Light colour White
 Required components:

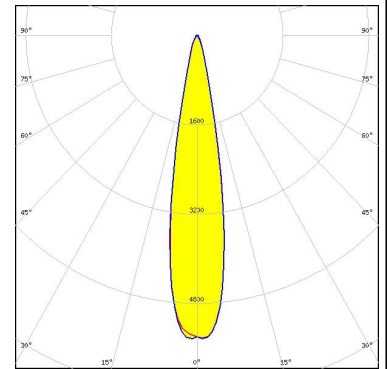

LED XHP35.2 HI
 FWHM / FWTM 16.0° / 29.0°
 Efficiency 94 %
 Peak intensity 8.7 cd/lm
 LEDs/each optic 1
 Light colour White
 Required components:

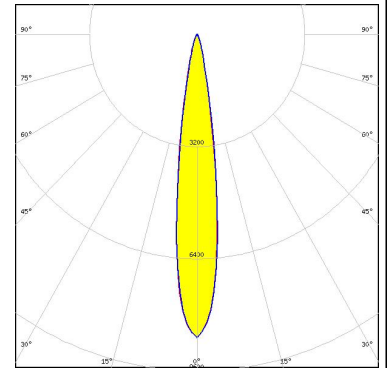

LED LUXEON CZ
 FWHM / FWTM 6.0° / 14.0°
 Efficiency 96 %
 Peak intensity 48.9 cd/lm
 LEDs/each optic 1
 Light colour White
 Required components:

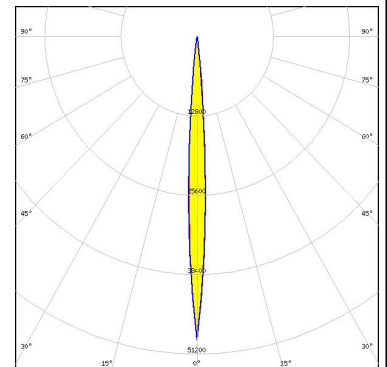

LED LUXEON HL2X
 FWHM / FWTM 14.0° / 26.0°
 Efficiency 94 %
 Peak intensity 11.1 cd/lm
 LEDs/each optic 1
 Light colour White
 Required components:

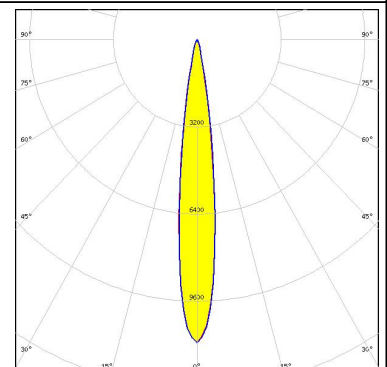

OPTICAL RESULTS (SIMULATED):

LUMILEDS

LED LUXEON HL2Z
 FWHM / FWTM 10.0° / 20.0°
 Efficiency 95 %
 Peak intensity 19.8 cd/lm
 LEDs/each optic 1
 Light colour White
 Required components:

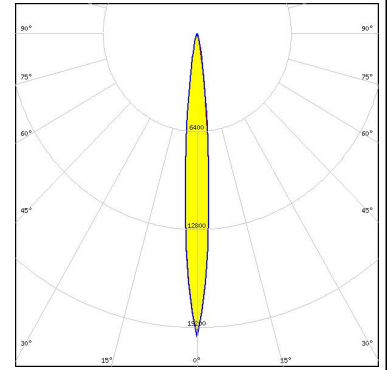

LUMILEDS

LED LUXEON MZ
 FWHM / FWTM 18.0° / 31.0°
 Efficiency 95 %
 Peak intensity 7.2 cd/lm
 LEDs/each optic 1
 Light colour White
 Required components:

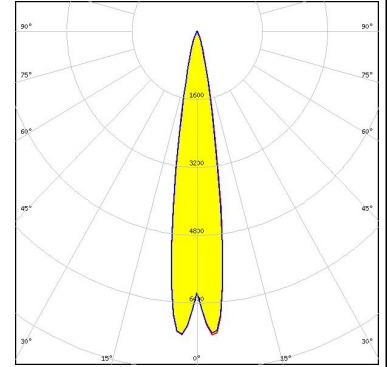

LUMILEDS

LED LUXEON Rubix
 FWHM / FWTM 6.0° / 14.0°
 Efficiency 96 %
 Peak intensity 48.4 cd/lm
 LEDs/each optic 1
 Light colour Red
 Required components:

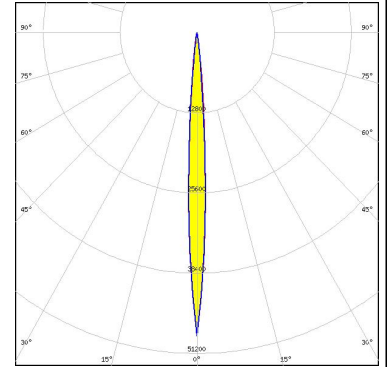

LUMILEDS

LED LUXEON Rubix
 FWHM / FWTM 6.0° / 14.0°
 Efficiency 96 %
 Peak intensity 47.2 cd/lm
 LEDs/each optic 1
 Light colour White
 Required components:

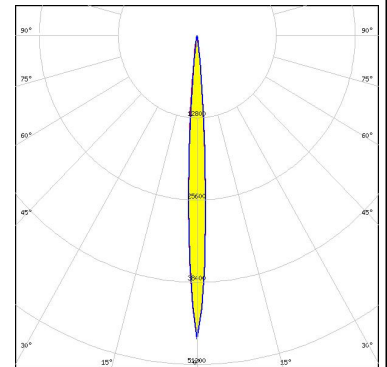

OPTICAL RESULTS (SIMULATED):

LUMILEDS

LED LUXEON Rubix
 FWHM / FWTM 6.0° / 14.0°
 Efficiency 96 %
 Peak intensity 45.6 cd/lm
 LEDs/each optic 1
 Light colour Blue
 Required components:

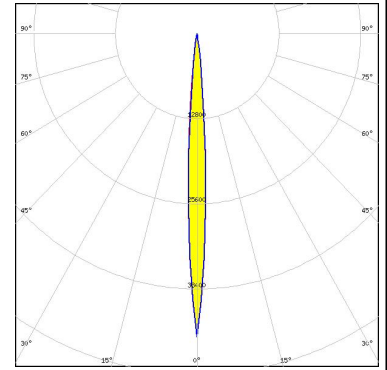

LUMILEDS

LED LUXEON Rubix
 FWHM / FWTM 6.0° / 14.0°
 Efficiency 96 %
 Peak intensity 46.4 cd/lm
 LEDs/each optic 1
 Light colour Green
 Required components:

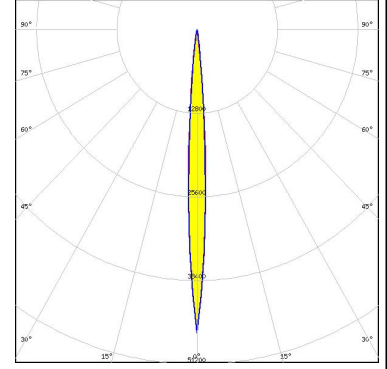

LUMILEDS

LED LUXEON SunPlus 20 Line (120 deg)
 FWHM / FWTM 8.0° / 16.0°
 Efficiency 96 %
 Peak intensity 30 cd/lm
 LEDs/each optic 1
 Light colour White
 Required components:

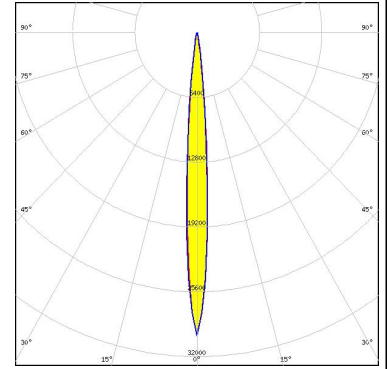

LUMILEDS

LED LUXEON SunPlus 20 Line (150 deg)
 FWHM / FWTM 8.0° / 17.0°
 Efficiency 91 %
 Peak intensity 28.5 cd/lm
 LEDs/each optic 1
 Light colour White
 Required components:

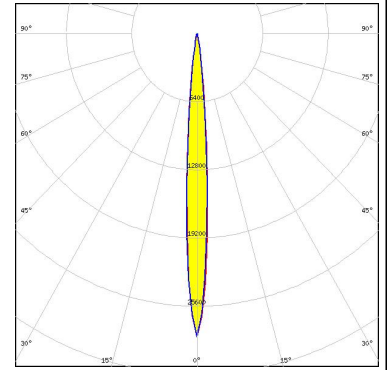

OPTICAL RESULTS (SIMULATED):

LUMILEDS

LED LUXEON Z
 FWHM / FWTM 6.0° / 14.0°
 Efficiency 95 %
 Peak intensity 51.7 cd/lm
 LEDs/each optic 1
 Light colour White
 Required components:

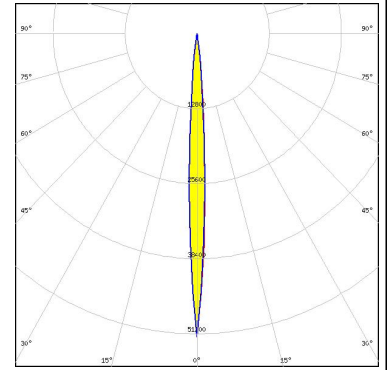

LUMILEDS

LED LUXEON Z ES
 FWHM / FWTM 7.7° / 17.0°
 Efficiency 94 %
 Peak intensity 33.3 cd/lm
 LEDs/each optic 1
 Light colour White
 Required components:

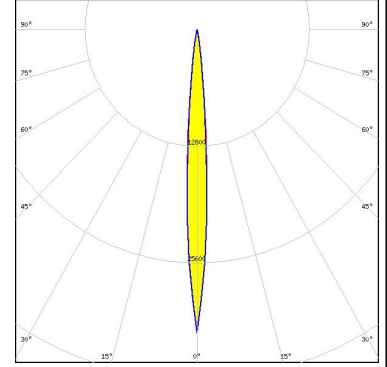

LUMINUS

LED SST-20
 FWHM / FWTM 10.0° / 19.0°
 Efficiency 94 %
 Peak intensity 22.1 cd/lm
 LEDs/each optic 1
 Light colour White
 Required components:

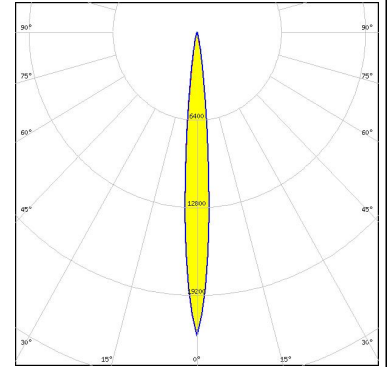

NICHIA

LED NVSW519A
 FWHM / FWTM 14.0° / 28.0°
 Efficiency 92 %
 Peak intensity 9.4 cd/lm
 LEDs/each optic 1
 Light colour White
 Required components:

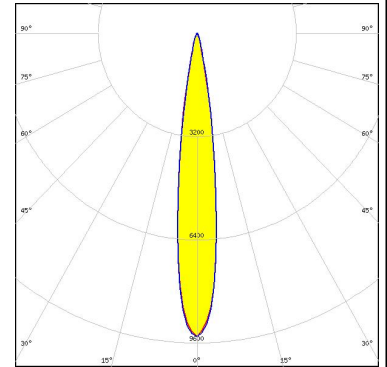

OPTICAL RESULTS (SIMULATED):

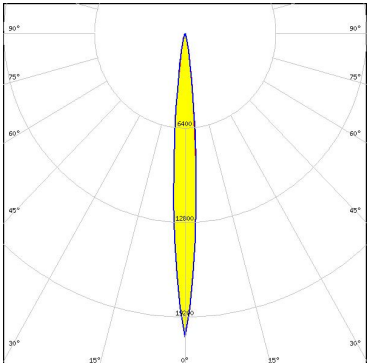
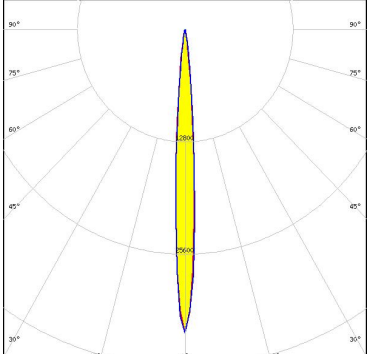
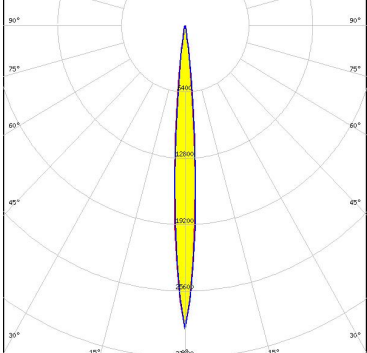
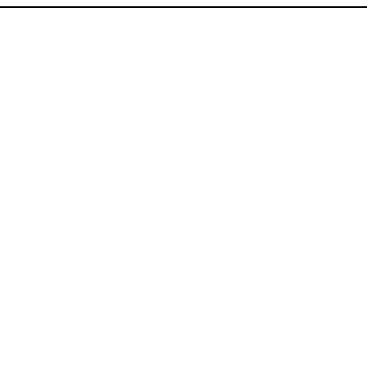
<p>NICHIA</p> <p>LED NVSxE21A FWHM / FWTM 8.0° / 20.0° Efficiency 93 % Peak intensity 20.6 cd/lm LEDs/each optic 1 Light colour White Required components:</p>	
<p>OSRAM Opto Semiconductors</p> <p>LED OSCONIQ P 3030 FWHM / FWTM 7.1° / 16.0° Efficiency 96 % Peak intensity 34.6 cd/lm LEDs/each optic 1 Light colour White Required components:</p>	
<p>OSRAM Opto Semiconductors</p> <p>LED OSOLON PURE 1010 FWHM / FWTM 8.0° / 16.0° Efficiency 93 % Peak intensity 29.2 cd/lm LEDs/each optic 1 Light colour White Required components:</p>	
<p>OSRAM Opto Semiconductors</p> <p>LED OSOLON Square EC FWHM / FWTM 12.0° Efficiency % Peak intensity 11.8 cd/lm LEDs/each optic 1 Light colour White Required components:</p>	

OPTICAL RESULTS (SIMULATED):

<p>OSRAM Opto Semiconductors</p> <p>LED: SFH 4170S FWHM / FWTM: 6.0° / 14.0° Efficiency: 88 % LEDs/each optic: 1 Light colour: IR Required components:</p>	
<p>SAMSUNG</p> <p>LED: LH351B FWHM / FWTM: 12.0° / 22.0° Efficiency: 94 % Peak intensity: 14.2 cd/lm LEDs/each optic: 1 Light colour: White Required components:</p>	
<p>SAMSUNG</p> <p>LED: LH351C FWHM / FWTM: 12.0° / 24.0° Efficiency: 95 % Peak intensity: 13.4 cd/lm LEDs/each optic: 1 Light colour: White Required components:</p>	

GENERAL INFORMATION:

NOTE: The typical beam angle will be changed by different color, chip size and chip position tolerance. The typical total beam angle is the full angle measured where the luminous intensity is half of the peak value.

MATERIALS:

As part of our continuous research and improvement processes, and to ensure the best possible quality and availability of our products, LEDiL reserves the right to change material grades without notice.

PRODUCT DATA USER AGREEMENT AND DISCLAIMER:

The measured data in the provided downloadable LEDiL Product Datasheets and Mechanical 2D-Drawings is rounded and provided as reference for planning. LEDiL Oy's optical specifications have been verified by conducting performance testing of the products in accordance with the company's quality system. The reported data are averaged results of multiple measurements with typical variation. LEDiL Oy reserves the right to without prior notification make changes and improvements to its products.

LEDiL Oy assumes neither warranty, nor guarantee nor any other liability of any kind for the contents and correctness of the provided data. The provided data has been generated with highest diligence but the provided data may in reality not represent the complete possible variation range of all intrinsic parameters. Therefore, in certain cases a deviation from the provided data could occur.

LEDiL Oy reserves the right to undertake technical changes of its products without further notification which could lead to changes in the provided data. LEDiL Oy assumes no liability of any kind for the possible deviation from any provided data or any other damage resulting from the usage of the provided data.

The user agrees to this disclaimer and user agreement with the download or usage of the provided files.

LEDiL Oy

Joensuunkatu 13
FI-24240 SALO
Finland

LEDiL Inc.

228 West Page Street
Suite D
Sycamore IL 60178
USA

Ledil Optics Technology (Shenzhen) Co., Ltd.

405 , Block B
Casic Motor Building
Shenzhen 518057
P.R.CHINA

Local sales and technical support

[www.ledil.com/
where_to_buy](http://www.ledil.com/where_to_buy)

Shipping locations

Salo, Finland
Hong Kong, China

Distribution Partners

[www.ledil.com/
where_to_buy](http://www.ledil.com/where_to_buy)