

SMD Switching Diode

CDSSC4148N-G

Voltage: 75 V

Current: 150mA

RoHS Device

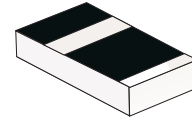

Features

- Designed for mounting on small surface.
- Silicon Epitaxial Planar Diode.
- Fast switching diode.
- Lead free

Mechanical data

- Case: 0805
- Marking: Cathode Band.
- Weight: 0.006 gram(approx.).

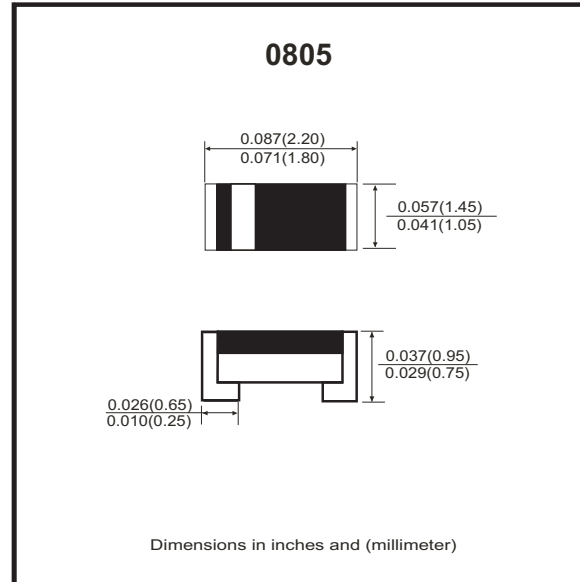

Thermal Characteristics (Parameter at Tamb = 25°C)¹⁾

Parameter	Symbol	Value	Unit
Forward Power Dissipation Power derating above 25 °C	P _{tot}	200	mW
		1.60	mW/°C
Junction Temperature	T _J	150	°C
Thermal Resistance Junction to Ambient Air	R _{θJA}	375	°C/W
Operating & Storage Temperature Range	T _{STG}	-55 to +150	°C

Maximum Rating (Parameter at Tamb = 25°C)¹⁾

Parameter	Symbol	Value	Unit
Repetitive Peak Reverse Voltage	V _{RMM}	100	V
Average rectified current sin half wave rectification with resistive load	I _{F(AV)}	150	mA
Repetitive Peak Forward Current at Tamb=25°C	I _{FRM}	300	mA
Non-Repetitive Surge Forward Current at t<1s and Tj=25°C at t≤8.3ms and Tj=25°C	I _{FSM}	500	mA
		1000	mA

Electrical Characteristics (Parameter at Tamb = 25°C)¹⁾

Parameter	Symbol	Value	Unit
MAX. Forward Voltage at I _F =10mA at I _F =100mA	V _F	1.0	V
		1.25	V
MAX. Leakage Current at V _R =20V at V _R =75V	I _R	0.025	uA
		5	uA
Capacitance at V _R =0V,f=1MHz	C _{tot}	4	pF
Reverse Recovery Time at I _F =I _R =10mA, R _L =100Ω	T _{rr}	4	ns

Notes:

1.) Valid provided that components are kept at ambient temperature.

RATING AND CHARACTERISTIC CURVES (CDSSC4148N-G)

Fig.1 - Forward characteristics

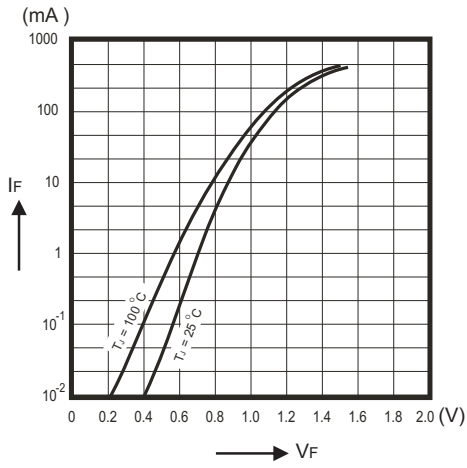

Fig.2 - Power De-rating

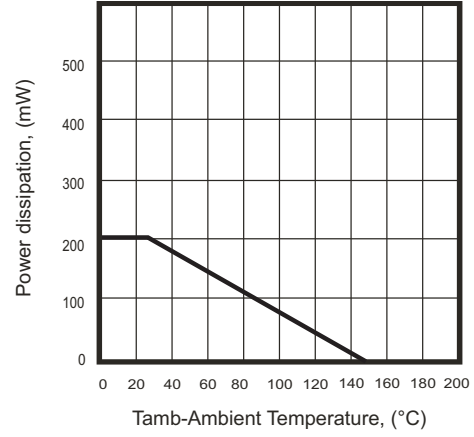

Fig.3 - Forward Current De-rating

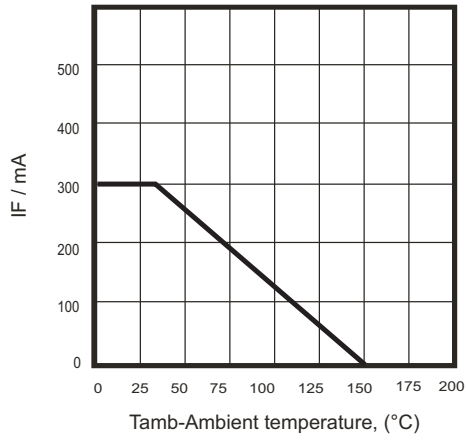
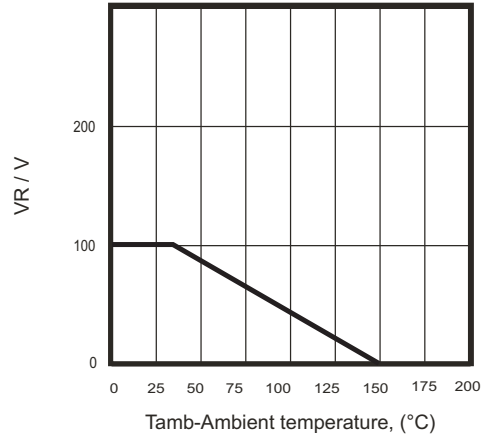
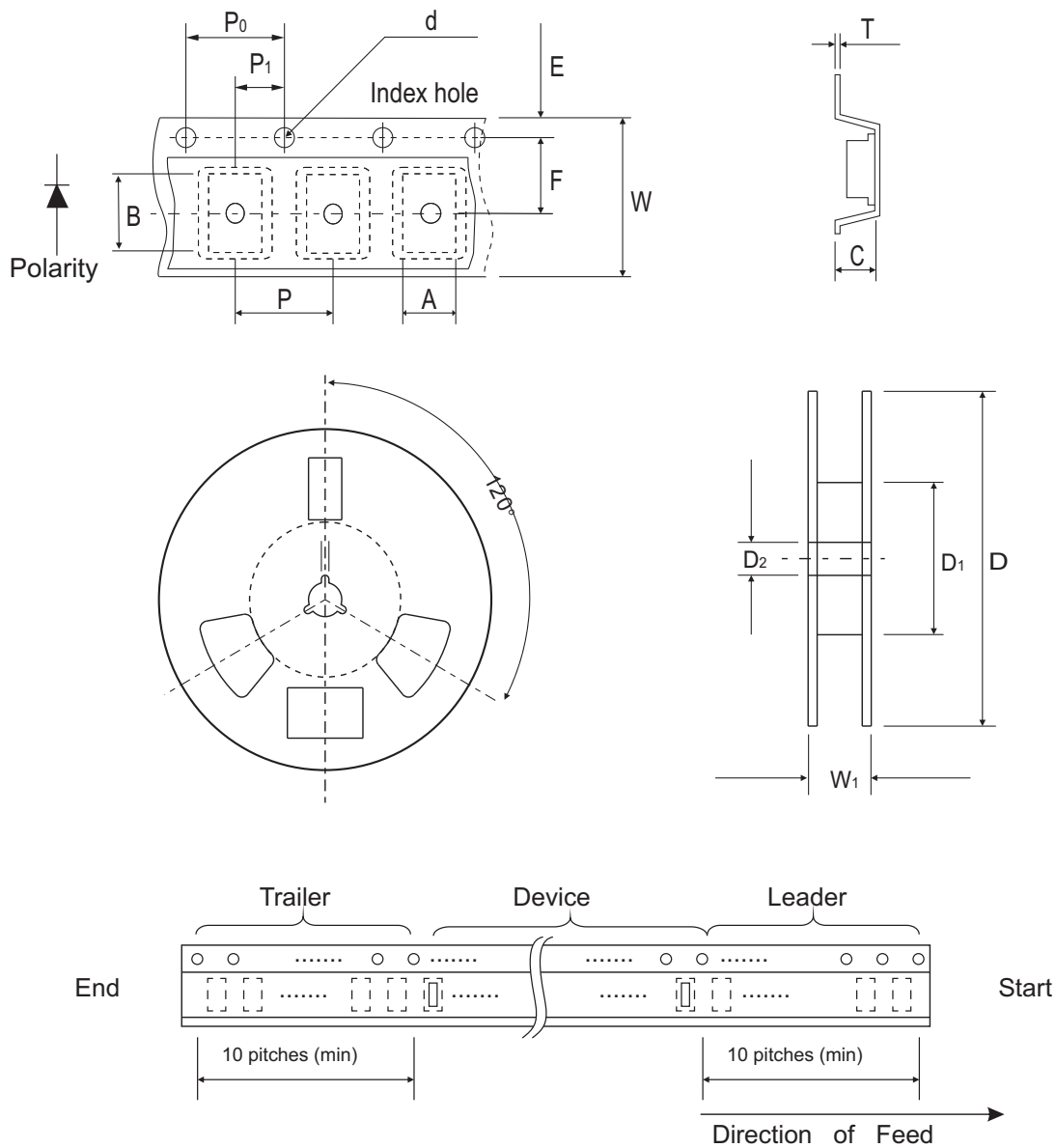

Fig.4 - Relative Voltage De-rating



Reel Taping Specification



0805	SYMBOL	A	B	C	d	D	D1	D2
	(mm)	1.65 ± 0.20	2.40 ± 0.20	0.95 ± 0.05	1.50 ± 0.10	178.0 ± 1.00	60.0 ± 1.00	13.0 ± 0.30
	(inch)	0.065 ± 0.008	0.094 ± 0.008	0.037 ± 0.002	0.059 ± 0.004	7.007 ± 0.040	2.362 ± 0.040	0.512 ± 0.012

0805	SYMBOL	E	F	P	P0	P1	W	W1
	(mm)	1.75 ± 0.10	3.50 ± 0.10	4.00 ± 0.10	4.00 ± 0.10	2.00 ± 0.05	8.00 ± 0.20	9.50 ± 0.30
	(inch)	0.689 ± 0.004	0.138 ± 0.004	0.157 ± 0.004	0.157 ± 0.004	0.079 ± 0.002	0.315 ± 0.008	0.374 ± 0.012

Suggested PAD Layout

SIZE	0805	
	(mm)	(inch)
A	1.70-2.10	0.067-0.083
B	0.50-0.90	0.020-0.035
C	1.20-1.40	0.047-0.055
D	2.20-3.00	0.087-0.118
E	1.20	0.047

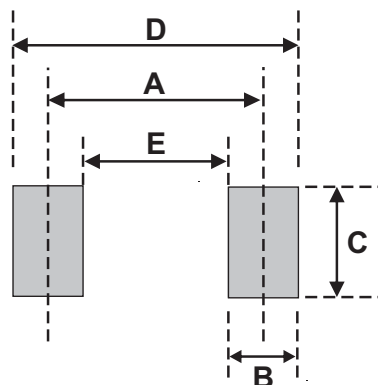

Standard Packaging

Case Type	REEL PACK	
	REEL (pcs)	Reel Size (inch)
0805	5,000	7