

**Mounting Option**

03-.116 (2.95) I.D. Floating Eyelets

**Contact Detail**

555-Extender Board Bend (Code 500 Contacts)  
 .156 [3.96] Contact Spacing x .140 [3.56] Row Spacing

THIS IS A C.A.D. GENERATED DRAWING  
 DO NOT MAKE MANUAL REVISIONS TO MASTER.



ISSUE NUMBER

ORIGINAL

Card Slot Accepts  
 .054 (1.37) to .070 (1.78)  
 Thick P.C. Board

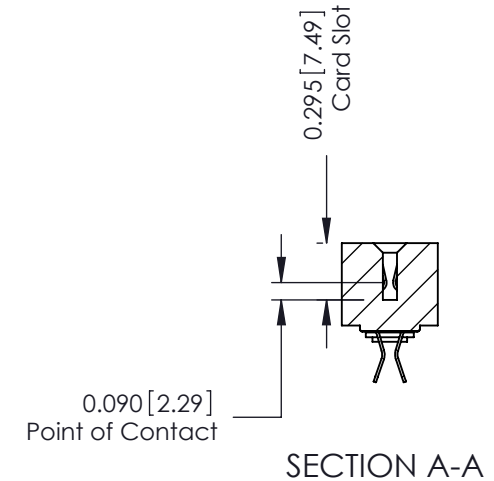
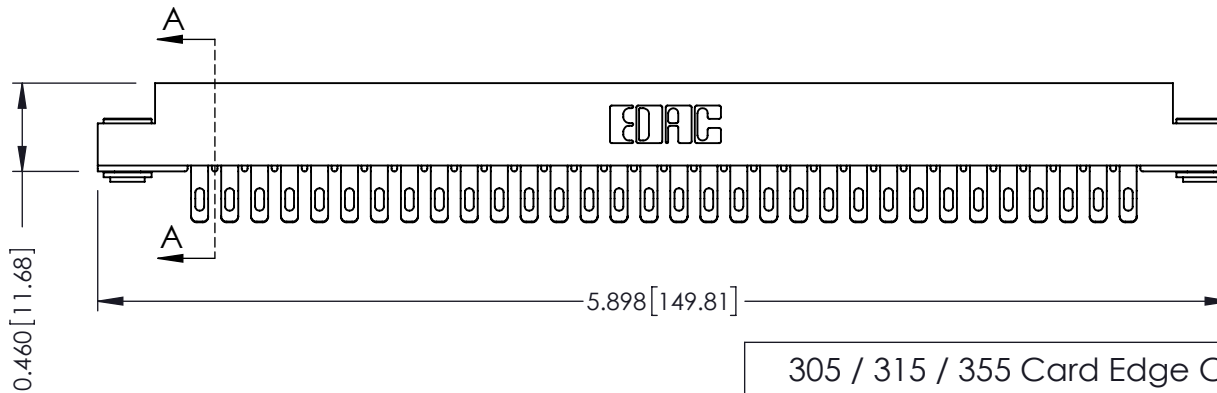
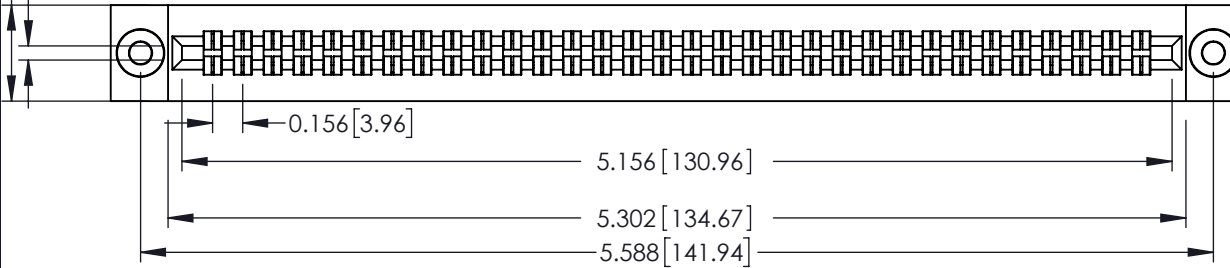

See Accompanying Page for:  
 • Mounting Options

305 / 315 / 355 Card Edge Connector  
 Part Number: 305-064-555-203



EDAC INC  
 TORONTO, ONTARIO  
 CANADA

YOUR CONNECTION TO QUALITY & SERVICE

THESE DRAWINGS AND SPECIFICATIONS  
 ARE THE PROPERTY OF EDAC INC. AND  
 SHALL NOT BE REPRODUCED, OR COPIED  
 OR USED AS THE BASIS FOR THE  
 MANUFACTURE OR SALE OF APPARATUS  
 WITHOUT WRITTEN PERMISSION.

|                                   |                   |
|-----------------------------------|-------------------|
| ACAD REFERENCE NO. 305 ENG MASTER |                   |
| DRAWN: J.LEE                      | DATE: SEPT. 21/09 |
| CHECKED:                          | DATE:             |
| SCALE: NTS                        | SHEET 1 OF 2      |
| DRAWING NUMBER<br>305 Assembly    | ISSUE<br>1        |

THIS IS A C.A.D. GENERATED DRAWING  
DO NOT MAKE MANUAL REVISIONS TO MASTER.



ISSUE NUMBER

ORIGINAL



|  |  |                                   |                   |
|--|--|-----------------------------------|-------------------|
| <b>305 / 315 / 355 Card Edge Connector<br/>Mounting Options</b>  |  | ACAD REFERENCE NO. 305 ENG MASTER |                   |
|  |  | DRAWN: J.LEE                      | DATE: SEPT. 21/09 |
|  EDAC INC<br>TORONTO, ONTARIO<br>CANADA<br>YOUR CONNECTION TO QUALITY & SERVICE                              |  | CHECKED:                          |                   |
|  |  | DATE:                             |                   |
| THESE DRAWINGS AND SPECIFICATIONS ARE THE PROPERTY OF EDAC INC. AND SHALL NOT BE REPRODUCED, OR COPIED OR USED AS THE BASIS FOR THE MANUFACTURE OR SALE OF APPARATUS WITHOUT WRITTEN PERMISSION. |  | SCALE: NTS                        | SHEET 2 OF 2      |
|  |  | DRAWING NUMBER<br>305 Assembly    | ISSUE<br>1        |