

Mounting Option

08-#4-40 Unified Threaded Inserts

Contact Detail

556-Extender Board Bend (Code 520 Contacts)
 .156 [3.96] Contact Spacing x .140 [3.56] Row Spacing

THIS IS A C.A.D. GENERATED DRAWING
 DO NOT MAKE MANUAL REVISIONS TO MASTER.



ISSUE NUMBER

ORIGINAL

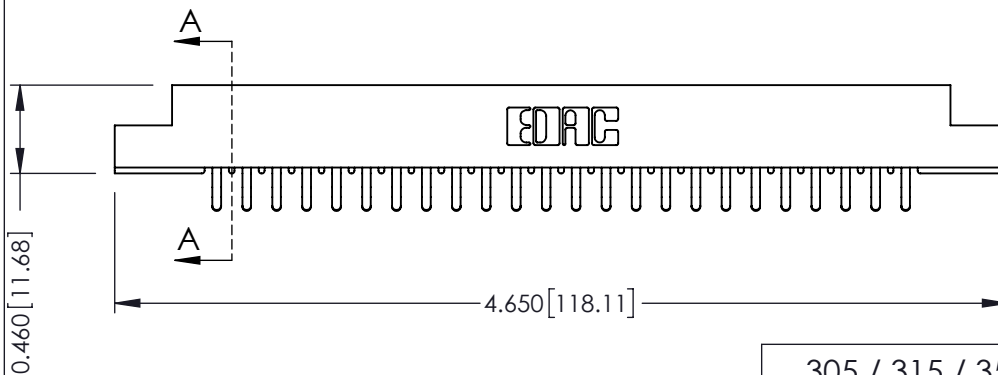
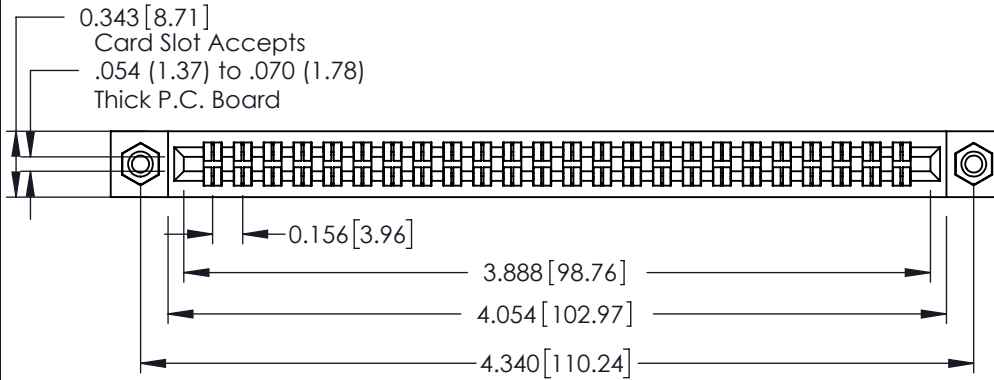

See Accompanying Page for:
 • Mounting Options

305 / 315 / 355 Card Edge Connector

Part Number: 315-048-556-208



EDAC INC
 TORONTO, ONTARIO
 CANADA

YOUR CONNECTION TO QUALITY & SERVICE

THESE DRAWINGS AND SPECIFICATIONS
 ARE THE PROPERTY OF EDAC INC. AND
 SHALL NOT BE REPRODUCED, OR COPIED
 OR USED AS THE BASIS FOR THE
 MANUFACTURE OR SALE OF APPARATUS
 WITHOUT WRITTEN PERMISSION.

ACAD REFERENCE NO. 305 ENG MASTER

DRAWN: J.LEE DATE: SEPT. 21/09

CHECKED: DATE:

SCALE: NTS SHEET 1 OF 2

DRAWING NUMBER 305 Assembly ISSUE 1

THIS IS A C.A.D. GENERATED DRAWING
DO NOT MAKE MANUAL REVISIONS TO MASTER.



ISSUE NUMBER

ORIGINAL



<h3>305 / 315 / 355 Card Edge Connector Mounting Options</h3>		ACAD REFERENCE NO. 305 ENG MASTER	
		DRAWN: J.LEE	DATE: SEPT. 21/09
 EDAC INC TORONTO, ONTARIO CANADA YOUR CONNECTION TO QUALITY & SERVICE		CHECKED: DATE:	
		SCALE: NTS	SHEET 2 OF 2
THESE DRAWINGS AND SPECIFICATIONS ARE THE PROPERTY OF EDAC INC. AND SHALL NOT BE REPRODUCED, OR COPIED OR USED AS THE BASIS FOR THE MANUFACTURE OR SALE OF APPARATUS WITHOUT WRITTEN PERMISSION.		DRAWING NUMBER	ISSUE
		305 Assembly	1