

| REVISIONS | | | | | |
|-----------|-----|----------------|-------------|-------|-------|
| REV | ECO | DESCRIPTION | DATE | BY | APPR |
| A1 | - | RELEASE NUMBER | 27/JUL/2021 | LOUIE | TOMMY |

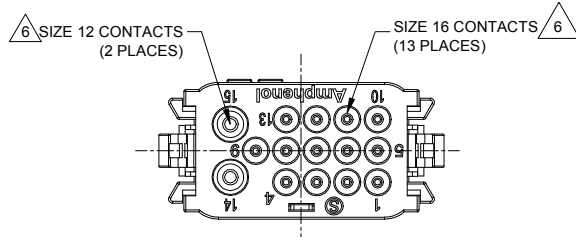
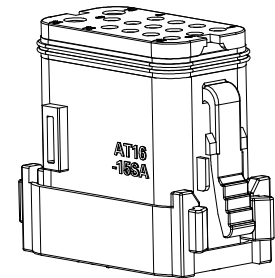
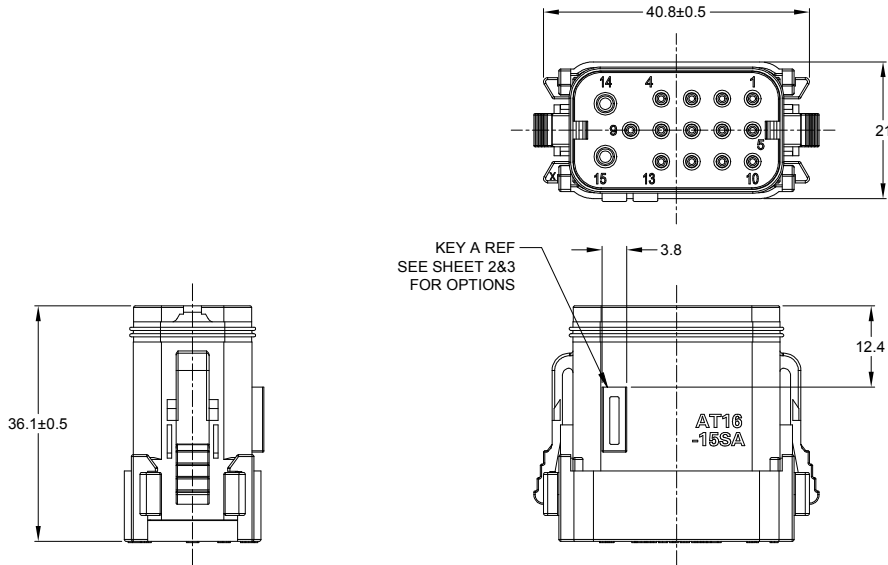

△ CONTACT SIZE AND REAR SEAL WIRE RANGE

| CONTACT SIZE | MIN. INSUL O.D. | MAX. INSUL O.D. | TYPICAL WIRE RANGE |
|--------------|-------------------|-------------------|-----------------------|
| 12 | 2.46 mm (.097 in) | 4.01 mm (.158 in) | 10 - 14 AWG (3.0-2.0) |
| 16 | 1.35 mm (.053 in) | 3.05 mm (.120 in) | 14 - 20 AWG (2.0-0.5) |

NOTES: UNLESS OTHERWISE SPECIFIED

- MATERIAL:**
HOUSING: THERMOPLASTIC; COLOR: SEE CHART
END CAP: THERMOPLASTIC; COLOR: BLACK
SEALS: SILICONE RUBBER; COLOR: RED (FRONT SEAL), GREEN(REAR SEAL)
- MODIFICATIONS:** END CAP, REDUCED DIAMETER SEAL.
- SPECIFICATIONS:**
 - CURRENT RATING: SIZE 16, 13 AMPS; SIZE 12, 25 AMPS.
 - OPERATING TEMPERATURE: -55°C TO +125°C
 - DIELECTRIC WITHSTANDING VOLTAGE: LESS THAN 2 MILLIAMPS CURRENT LEAKAGE @ 1500 VOLTS AC.
 - INSULATION RESISTANCE: 1000 MEGOHMS MIN @ 25°C.
 - MOISTURE RESISTANCE:
IP68(1M OF WATER FOR A PERIOD OF 24 HOURS , MATED CONDITION)
IP69K(MATED CONDITION)
 - MATING CYCLE DURABILITY: 100 CYCLES
 - RoHS COMPLIANT
- MATING PART:** AT16-15PX-* RECEPTACLES
(X = A,B,C,D,E KEYS; * = MODIFICATIONS AND COLORS)
- ALL DIMENSIONS ARE FOR REFERENCE USE ONLY.**

TITLE: 15 POSITION PLUG, SOCKET,AT SERIES
DWG NO: AT16-15SX-XXXX
REV: A1
SH: 1
OF: 3

| QUANTITY | SEE PIN CHART | REF: DT16-15SA-K003, DT16-15SB-K003, DT16-15SC-K003, DT16-15SD-K003, DT16-15SE-K003 |
|--|---------------|--|
| PART NUMBER | | DESCRIPTION |
| MATERIALS LIST | | |
| UNLESS OTHERWISE SPECIFIED 1) All dimensions are in metric(mm). 2) Tolerances are as follows: 1 PL DEC ±0.30 Fractions ±1/64 2 PL DEC ±0.15 Angles ±1° 3 PL DEC ±0.08 3) Note reference = △ | | SINE Systems Corporation A Subsidiary of Amphenol Corporation 44724 Morley Drive Clinton Township, MI 48036 |
| SIGNATURES: DRAWN: LOUIE YN, CHECKED: ORON LI, ENGINEER: TOMMY XIE, APPROVAL: TOMMY XIE, DATE: 27/JUL/2021, 28/JUL/2021, 28/JUL/2021 | | 15 POSITION PLUG, SOCKET,AT SERIES |
| MATERIAL SPECIFICATIONS: PROCESS SPECIFICATIONS: NEXT ASSY: | | THIS DRAWING IS SUPPLIED FOR INFORMATION ONLY. DESIGN FEATURES, SPECIFICATIONS AND PERFORMANCE DATA SHOWN HEREON ARE THE PROPERTY OF THE AMPHENOL CORPORATION. NO RIGHTS OF REPRODUCTION ARE IMPLIED. ALL DIMENSIONS ARE SUBJECT TO NORMAL MANUFACTURING VARIATIONS. |
| SIZE: B C- SCALE: NONE | | FSCM NO: DWG NO: AT16-15SX-XXXX REVISION: A1 SHEET 1 OF 3 |

| REVISIONS | | | | | |
|-----------|-----|----------------|-------------|-------|-------|
| REV | ECO | DESCRIPTION | DATE | BY | APPR |
| A1 | - | RELEASE NUMBER | 27/JUL/2021 | LOUIE | TOMMY |

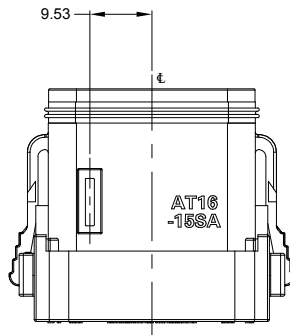

| KEY-A CONFIGURATION | |
|---------------------|------------------|
| PART NUMBER | COLOR OF HOUSING |
| AT16-15SA-K003 | BLACK |
| AT16-15SA-EK02 | GRAY |

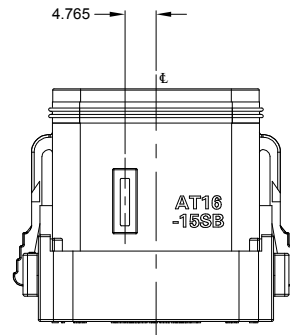

| KEY-B CONFIGURATION | |
|---------------------|------------------|
| PART NUMBER | COLOR OF HOUSING |
| AT16-15SB-K003 | BLACK |

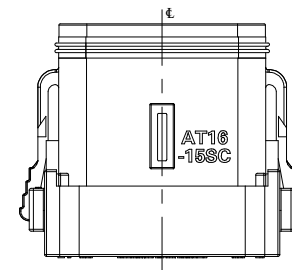

| KEY-C CONFIGURATION | |
|---------------------|------------------|
| PART NUMBER | COLOR OF HOUSING |
| AT16-15SC-K003 | BLACK |
| AT16-15SC-EK02 | GRAY |

TITLE: 15 POSITION PLUG, SOCKET, AT SERIES
 DWG NO: AT16-15SX-XXXX
 REV: A1
 SH: 2
 OF: 3

| SEE PN CHART | | DESCRIPTION | | ITEM |
|--|-------------|--|--|---|
| QUANTITY | PART NUMBER | DESCRIPTION | | ITEM |
| MATERIALS LIST | | | | |
| UNLESS OTHERWISE SPECIFIED 1) All dimensions are in metric(mm). 2) Tolerances are as follows: 1 PL DEC ±0.30 Fractions ±1/64 2 PL DEC ±0.15 Angles ±1° 3 PL DEC ±0.08 3) Note reference = | | SIGNATURES DRAWN: LOUIE YIN 27JUL2021 CHECKED: ORON LI 28JUL2021 ENGINEER: APPROVAL: TOMMY XIE 28JUL2021 CUSTOMER: | | SINE Systems Corporation A Subsidiary of Amphenol Corporation 44724 Morley Drive Clinton Township, MI 48036 |
| MATERIAL SPECIFICATIONS: PROCESS SPECIFICATIONS: NEXT ASSY: | | THIS DRAWING IS SUPPLIED FOR INFORMATION ONLY. DESIGN FEATURES, SPECIFICATIONS AND PERFORMANCE DATA SHOWN HEREON ARE THE PROPERTY OF THE AMPHENOL CORPORATION. NO RIGHTS OF REPRODUCTION ARE IMPLIED. ALL DIMENSIONS ARE SUBJECT TO NORMAL MANUFACTURING VARIATIONS. | | |
| | | SIZE B C- | FSCM NO. AT16-15SX-XXXX | REVISION A1 |
| | | SCALE: NONE | SHEET 2 OF 3 | |

| REVISIONS | | | | | |
|-----------|-----|----------------|-------------|-------|-------|
| REV | ECO | DESCRIPTION | DATE | BY | APPR |
| A1 | - | RELEASE NUMBER | 27/JUL/2021 | LOUIE | TOMMY |

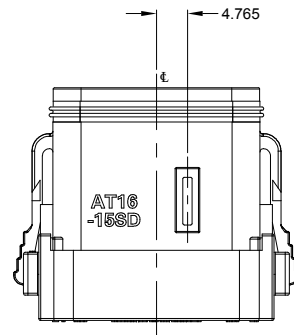

| KEY-D CONFIGURATION | |
|---------------------|------------------|
| PART NUMBER | COLOR OF HOUSING |
| AT16-15SD-K003 | BLACK |
| AT16-15SD-EK02 | GRAY |

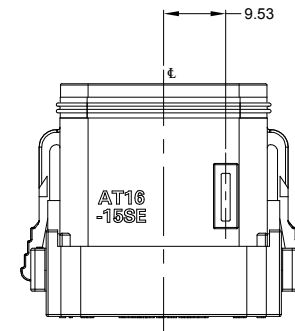



| KEY-E CONFIGURATION | |
|---------------------|------------------|
| PART NUMBER | COLOR OF HOUSING |
| AT16-15SE-K003 | BLACK |
| AT16-15SE-EK02 | GRAY |



TITLE: 15 POSITION PLUG, SOCKET, AT SERIES
 DWG NO: AT16-15SX-XXXX
 REV: A1
 SH: 3
 OF: 3

| SEE P/N CHART | | PART NUMBER | | DESCRIPTION | | ITEM |
|--|--|--|--|--|--|---|
| QUANTITY | | MATERIALS LIST | | | | |
| UNLESS OTHERWISE SPECIFIED 1) All dimensions are in metric (mm). 2) Tolerances are as follows: 1 PL DEC ±0.30 2 PL DEC ±0.15 3 PL DEC ±0.08 3) Note reference = | | SIGNATURES DRAWN: LOUIE YIN CHECKED: ORION LI ENGINEER: APPROVAL: TOMMY XIE | | DATE 27/JUL/2021 28/JUL/2021 28/JUL/2021 | | SINE Systems Corporation A Subsidiary of Amphenol Corporation 44724 Morley Drive Clinton Township, MI 48036 |
| MATERIAL SPECIFICATIONS: | | CUSTOMER: | | 15 POSITION PLUG, SOCKET, AT SERIES | | |
| PROCESS SPECIFICATIONS: | | THIS DRAWING IS SUPPLIED FOR INFORMATION ONLY. DESIGN FEATURES, SPECIFICATIONS AND PERFORMANCE DATA SHOWN HEREON ARE THE PROPERTY OF THE AMPHENOL CORPORATION. NO RIGHTS OF REPRODUCTION ARE IMPLIED. ALL DIMENSIONS ARE SUBJECT TO NORMAL MANUFACTURING VARIATIONS. | | SIZE FSCM NO. DWG NO. B C- AT16-15SX-XXXX | | REVISION A1 |
| NEXT ASSY: | | SCALE: NONE | | SHEET 3 OF 3 | | |



AT Series™ - Contact Size 16 Options

| Machined Contacts, Sockets & Pins | | | | |
|-----------------------------------|--|------|-------|----------|
| Part Number | Description | Size | AWG | Type |
| AT60-215-1631 | Male Contact - Pin, Gold-plated | 16 | 14 | Machined |
| AT62-209-1631 | Female Contact - Socket, Gold-plated | 16 | 14 | Machined |
| AT60-215-16141 | Male Contact - Pin, Nickel-plated | 16 | 14 | Machined |
| AT62-209-16141 | Female Contact - Socket, Nickel-plated | 16 | 14 | Machined |
| AT60-202-1631 | Male Contact - Pin, Gold-plated | 16 | 16-20 | Machined |
| AT62-201-1631 | Female Contact - Socket, Gold-plated | 16 | 16-20 | Machined |
| AT60-202-16141 | Male Contact - Pin, Nickel-plated | 16 | 16-20 | Machined |
| AT62-201-16141 | Female Contact - Socket, Nickel-plated | 16 | 16-20 | Machined |
| AT60-202-1631-22 | Male Contact - Pin, Gold-plated | 16 | 22-24 | Machined |
| AT62-201-1631-22 | Female Contact - Socket, Gold-plated | 16 | 22-24 | Machined |
| AT60-202-16141-22 | Male Contact - Pin, Nickel-plated | 16 | 22-24 | Machined |
| AT62-201-16141-22 | Female Contact - Socket, Nickel-plated | 16 | 22-24 | Machined |

| Tooling - Machined Contacts | | |
|---|-------------|---|
| Part | Part Number | Description |
|  | CA-5D12 | Universal Hand Crimp Tool, Size 12/16/20 (Machined contacts only) |
|  | CA-5E12 | Pneumatic Crimp Tool, Size 12/16/20 (Machined contacts only) |

| Contact Removal Tools | | |
|---|---------------|---|
| Part | Part Number | Description |
|  | ATRT-100 | Used for removal of contacts for A Series™ products |
|  | AT11-310-1605 | Contact Removal Tool, Plastic, Size 16 |
|  | A114017 | Sealing Plug, Size 16, White |

| Stamped & Formed Contacts, Sockets & Pins | | | | |
|---|--|------|-------|------------------|
| Part Number | Description | Size | AWG | Type |
| AT60-14-0144 | Male Contact - Pin, Gold-plated | 16 | 14-16 | Stamped & Formed |
| AT62-14-0144 | Female Contact - Socket, Gold-plated | 16 | 14-16 | Stamped & Formed |
| AT60-14-0122 | Male Contact - Pin, Nickel-plated | 16 | 14-16 | Stamped & Formed |
| AT62-14-0122 | Female Contact - Socket, Nickel-plated | 16 | 14-16 | Stamped & Formed |
| AT60-16-0144 | Male Contact - Pin, Gold-plated | 16 | 16-18 | Stamped & Formed |
| AT62-16-0144 | Female Contact - Socket, Gold-plated | 16 | 16-18 | Stamped & Formed |
| AT60-16-0122 | Male Contact - Pin, Nickel-plated | 16 | 16-18 | Stamped & Formed |
| AT62-16-0122 | Female Contact - Socket, Nickel-plated | 16 | 16-18 | Stamped & Formed |
| AT60-16-0644 | Male Contact - Pin, Gold-plated | 16 | 18-20 | Stamped & Formed |
| AT62-16-0644 | Female Contact - Socket, Gold-plated | 16 | 18-20 | Stamped & Formed |
| AT60-16-0622 | Male Contact - Pin, Nickel-plated | 16 | 18-20 | Stamped & Formed |
| AT62-16-0622 | Female Contact - Socket, Nickel-plated | 16 | 18-20 | Stamped & Formed |
| AT60-16-0844 | Male Contact - Pin, Gold-plated | 16 | 20-22 | Stamped & Formed |
| AT62-16-0844 | Female Contact - Socket, Gold-plated | 16 | 20-22 | Stamped & Formed |
| AT60-16-0822 | Male Contact - Pin, Nickel-plated | 16 | 20-22 | Stamped & Formed |
| AT62-16-0822 | Female Contact - Socket, Nickel-plated | 16 | 20-22 | Stamped & Formed |



| Tooling - Stamped & Formed Contacts | | |
|---|-------------|---|
| Part | Part Number | Description |
|  | MFX-3950 | Crimp Die - Size 16, 18-20AWG (S&F contacts only) |
| | MFX-3953 | Crimp Die - Size 16, 16-18AWG (S&F contacts only) |
| | MFX-3975 | Crimp Die - Size 16, 14-16AWG (S&F contacts only) |
| | MFX-3990 | Crimp Die - Size 16, 20-22AWG (S&F contacts only) |
|  | ATT-16-00 | Hand Crimp Tool - Size 16, 14-16AWG (S&F contacts only) |
| | ATT-16-01 | Hand Crimp Tool - Size 16, 18-20AWG (S&F contacts only) |
| | ATT-1612-03 | Hand Crimp Tool - Size 16, 20-22AWG (S&F contacts only) |



Amphenol Sine Systems
 44724 Morley Drive
 Clinton Township, MI 48036 USA
www.amphenol-sine.com
 09/2021

ATP Series™ - Contact Size 12 Options



| Machined Contacts, Sockets & Pins | | | | |
|-----------------------------------|--|------|-------|----------|
| Part Number | Description | Size | AWG | Type |
| AT60-204-12141-10 | Male Contact - Pin, Nickel-plated | 12 | 10-12 | Machined |
| AT62-203-12141-10 | Female Contact - Socket, Nickel-plated | 12 | 10-12 | Machined |
| AT60-220-1231 | Male Contact - Pin, Gold-plated | 12 | 12-14 | Machined |
| AT62-210-1231 | Female Contact - Socket, Gold-plated | 12 | 12-14 | Machined |
| AT60-204-12141 | Male Contact - Pin, Nickel-plated | 12 | 12-14 | Machined |
| AT62-203-12141 | Female Contact - Socket, Nickel-plated | 12 | 12-14 | Machined |

| DiagnosticGrade™ Machined Contacts, Sockets & Pins | | | | |
|--|--|------|-----|----------|
| • Smaller AWG for Diagnostic Applications • Gold-plated • Increased Mating Cycles • Cost-effective | | | | |
| Part Number | Description | Size | AWG | Type |
| 65-54749 | Male Contact - DiagnosticGrade™, Pin, Gold-plated | 12 | 20 | Machined |
| AT62-210-1231-1820 | Female Contact - DiagnosticGrade™, Socket, Gold-plated | 12 | 20 | Machined |

| Tooling - Machined Contacts | | |
|---|-------------|---|
| Part | Part Number | Description |
|  | CA-5D12 | Universal Hand Crimp Tool, Size 12/16/20 (Machined contacts only) |
|  | CA-5E12 | Pneumatic Crimp Tool, Size 12/16/20 (Machined contacts only) |

| Contact Removal Tools | | |
|---|---------------|---|
| Part | Part Number | Description |
|  | ATRT-100 | Used for removal of contacts for A Series™ products |
|  | AT11-337-1205 | Contact Removal Tool, Plastic, Size 12 |
|  | A114017 | Sealing Plug, Size 12, White |

| Stamped & Formed Contacts, Sockets & Pins | | | | |
|---|--|------|-------|------------------|
| Part Number | Description | Size | AWG | Type |
| AT60-12-0244 | Male Contact - Pin, Gold-plated | 12 | 10-12 | Stamped & Formed |
| AT62-12-0244 | Female Contact - Socket, Gold-plated | 12 | 10-12 | Stamped & Formed |
| AT60-12-0222 | Male Contact - Pin, Nickel-plated | 12 | 10-12 | Stamped & Formed |
| AT62-12-0222 | Female Contact - Socket, Nickel-plated | 12 | 10-12 | Stamped & Formed |
| AT60-12-0144 | Male Contact - Pin, Gold-plated | 12 | 12-14 | Stamped & Formed |
| AT62-12-0144 | Female Contact - Socket, Gold-plated | 12 | 12-14 | Stamped & Formed |
| AT60-12-0166 | Male Contact - Pin, Nickel-plated | 12 | 12-14 | Stamped & Formed |
| AT62-12-0166 | Female Contact - Socket, Nickel-plated | 12 | 12-14 | Stamped & Formed |

| Tooling - Stamped & Formed Contacts | | |
|---|-------------|---|
| Part | Part Number | Description |
|  | MXF-3973 | Crimp Die - Size 12 (S&F contacts only) |
| | MXF-3985 | Crimp Die - Size 12 (S&F contacts only) 10-12AWG -02XX Series |
|  | ATT-12-00 | Hand Crimp Tool - Size 12, 12AWG (S&F contacts only) |

Amphenol Sine Systems
 44724 Morley Drive
 Clinton Township, MI 48036 USA
www.amphenol-sine.com
 09/2021