

Universal MicroMod Connector

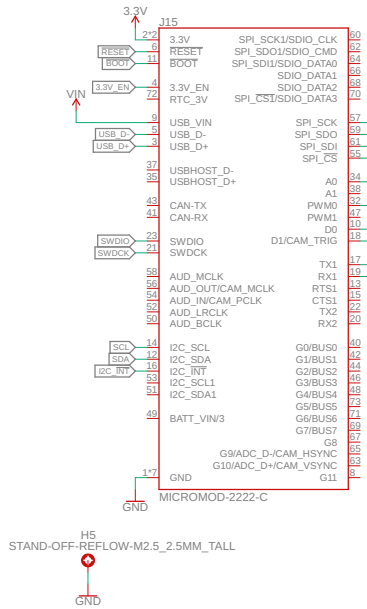

LED

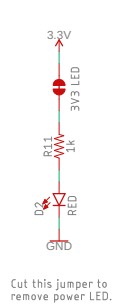

Debug Header

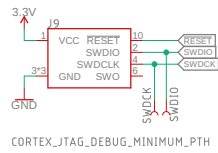

Voltage Regulation

This is the penny-in-the-fuse jumper. If you want to bypass the fuse, close this jumper.

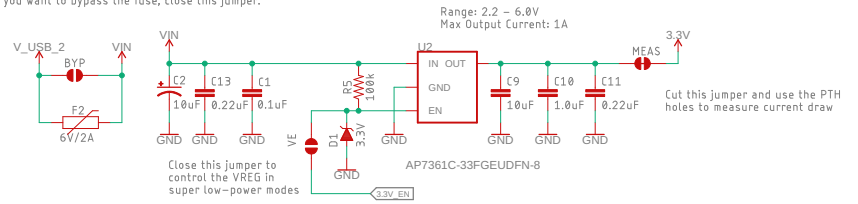

Battery Charger

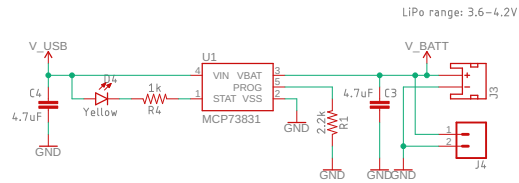

Power Source Select

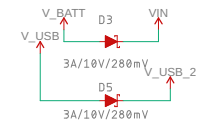

USB-C

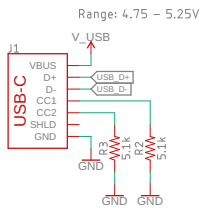

Qwiic Connector

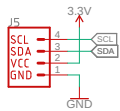
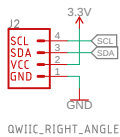

Buttons

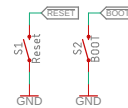

Header

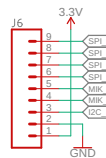

MikroBUS Socket

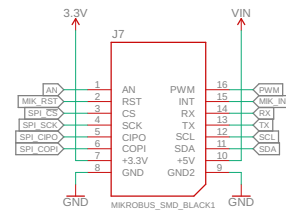

mikroBUS logo

QWIIIC



Released under the Creative Commons Attribution Share-Alike 4.0 License
<https://creativecommons.org/licenses/by-sa/4.0/>

TITLE: MM-MikroBUS-Carrier

Design by: Priyanka Makin

REV: v11

Date: 1/25/2022 9:44 AM

Sheet: 1/1