

REVISIONS

P	LTR	DESCRIPTION	DATE	DWN	APVD
	A	NEW RELEASE	22AUG2022	MK	IG

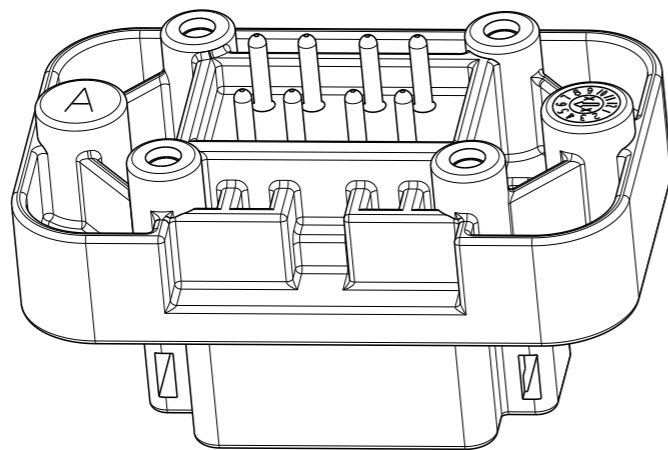

3D VIEW

Ø .130 [3.3]  
BLIND HOLE  
▽ .425 [10.80]  
#6-19 SCREW

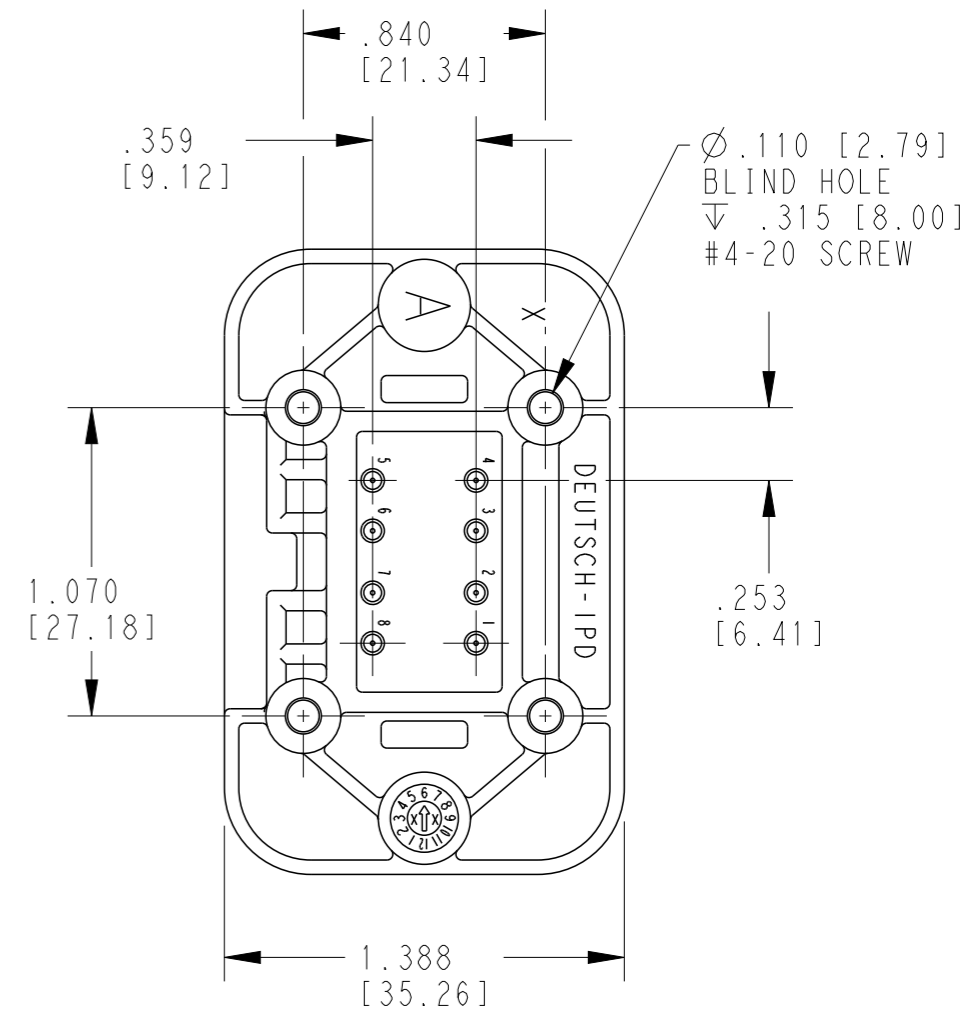
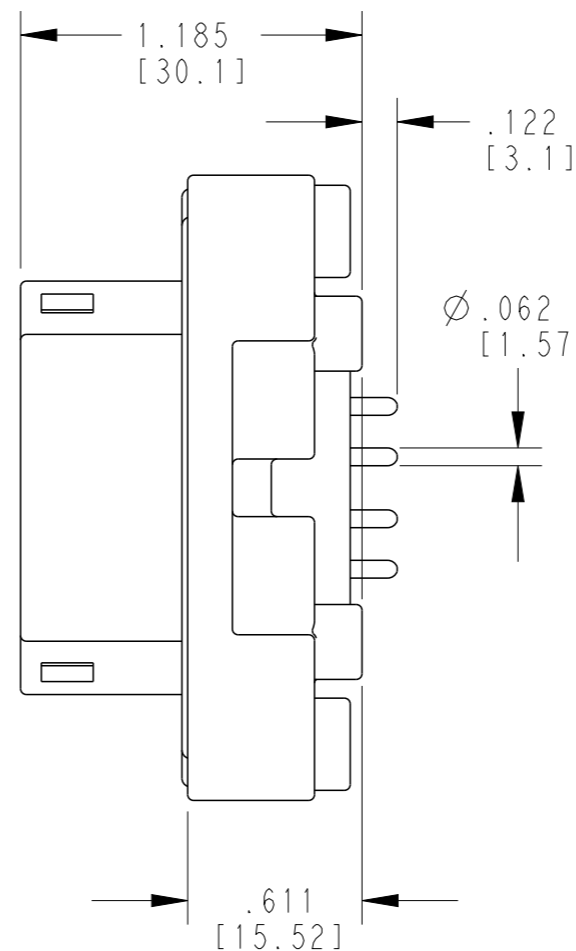
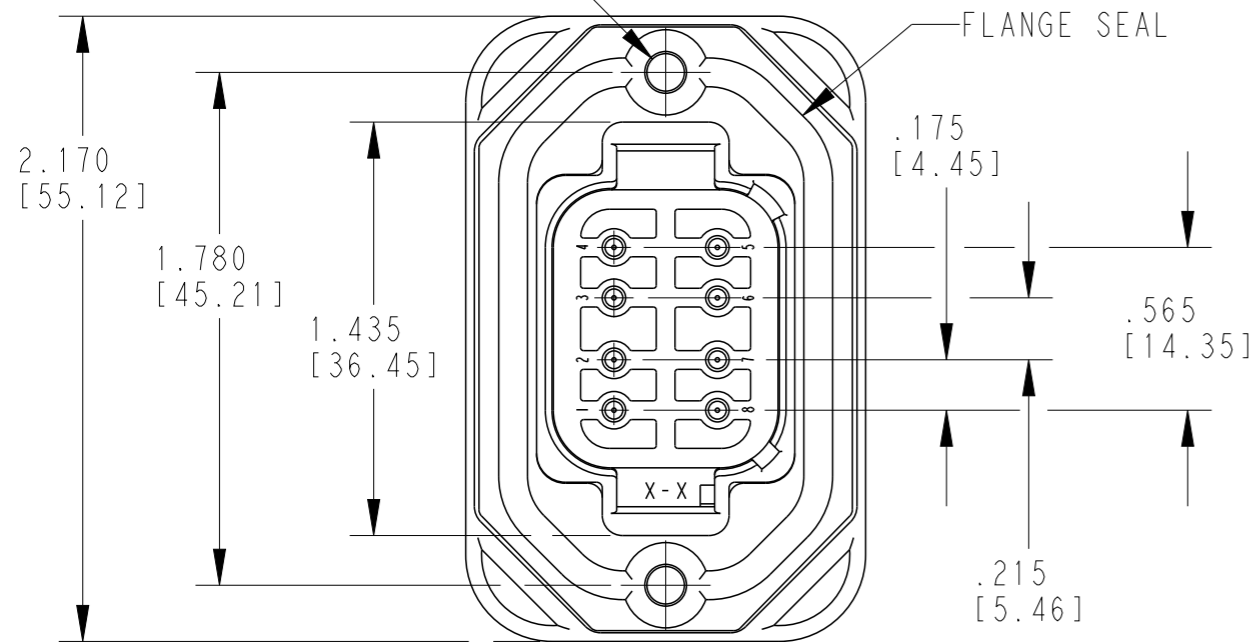

6 MINIMUM RECOMMENDED HOLE SIZE. CUSTOMER TO DETERMINE FINISHED HOLE SIZE BASED ON SOLDER PROCESS.

5. MOUNTING SCREW TORQUE VALUES ARE AS FOLLOWS:  
#6-19 SCREWS: 13±2.0 IN-LB [1.47±.23 N-M].  
#4-20 SCREWS: 8±2.0 IN-LB [.90±.23 N-M].  
VALUES VALID FOR PLASTITE 48 SCREWS ONLY.

4. RECOMMENDED MOUNTING SCREWS (NOT INCLUDED): CAMCAR PLASTITE 48.

3. THIS RECEPTACLE MATES WITH DT06-08SX-XXXX PLUG (XXXX = ALL MODIFICATIONS.)

2 SHELL MATERIAL: PA46 GF30 (GRAY); FLANGE SEAL MATERIAL: SILICONE.  
CONTACT PLATING- 1060-004-16307 MATING SIDE :NICKLE; PCB SIDE: TIN  
1060-004-16306 MATING SIDE : GOLD; PCB SIDE: TIN

1 DIMENSION TOLERANCE: ±.025 [.64]; PANEL CUTOUT ±.010 [.25]  
PIN LOCATIONS: ±.005 [.13]; MOUNTING HOLE LOCATIONS: ±.005 [.13]  
PCB LAYOUT: ±.005 [.13]

NOTES:

THIS DRAWING IS A CONTROLLED DOCUMENT.		DWN K. MUKESH 22AUG2022	TE Connectivity	
DIMENSIONS: INCHES [mm]		CHK D. HEIDI 24AUG2022		
TOLERANCES UNLESS OTHERWISE SPECIFIED:		APVD I. GRANTCHAROVA 25AUG2022	NAME PCB MOUNT RECEPTACLE 8 PINS STRAIGHT DT SERIES	
0 PLC ± 1 PLC ± 2 PLC ± 3 PLC ± 4 PLC ± ANGLES ±1°		PRODUCT SPEC 108-151009	RESTRICTED TO	
MATERIAL		APPLICATION SPEC	SIZE A3	CAGE CODE 4AFU8
FINISH		WEIGHT 26g	DRAWING NO DT15-08PX-XXXX	
2		CUSTOMER DRAWING	SCALE 1:1	SHEET 1 OF 4
			REV A	

REVISIONS

P	LTR	DESCRIPTION	DATE	DWN	APVD
-	-	SEE SHEET 1	-	-	-

6X  $\varnothing .074^{+.005}_{-.000}$   
 $[1.88^{+0.13}_{-.00}]$   
 AFTER PLATING

4X  $\varnothing .135^{+.005}_{-.000}$   
 $[3.43^{+0.13}_{-.00}]$

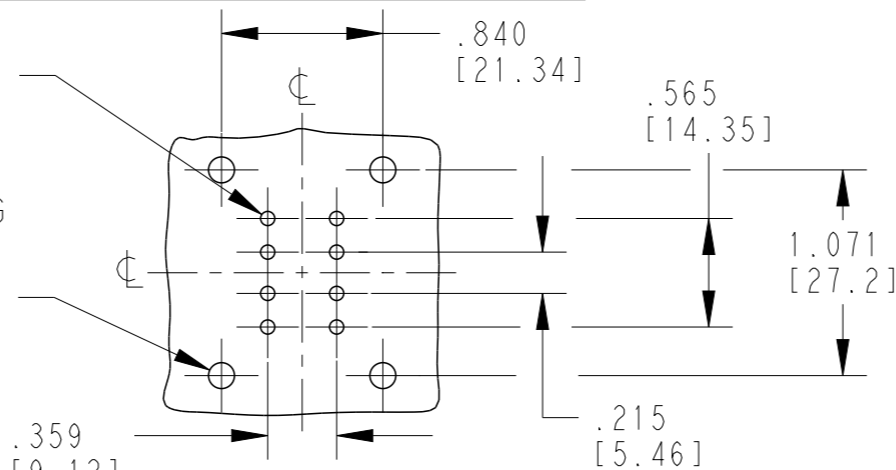

RECOMMENDED PCB LAYOUT

A KEYWAY

B KEYWAY

C KEYWAY

D KEYWAY

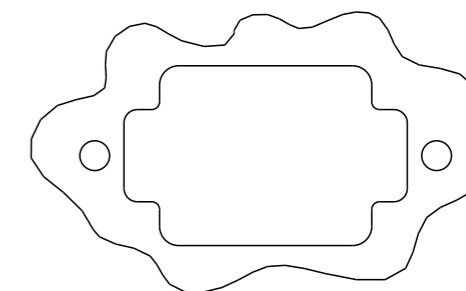
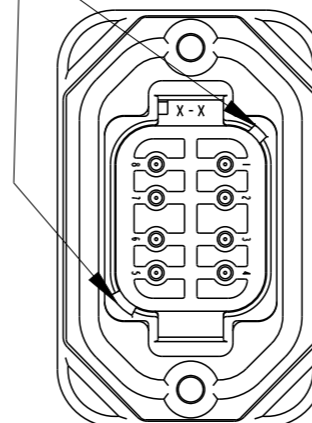
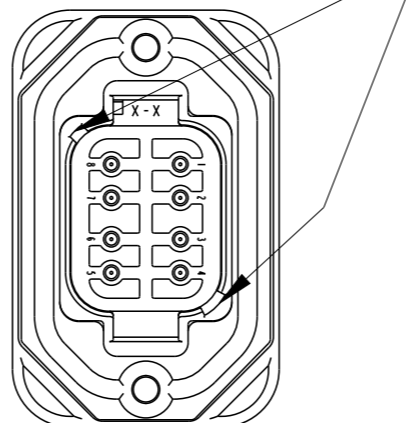
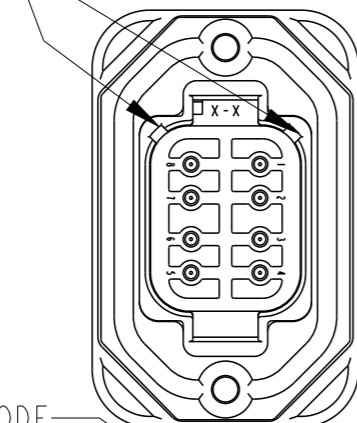
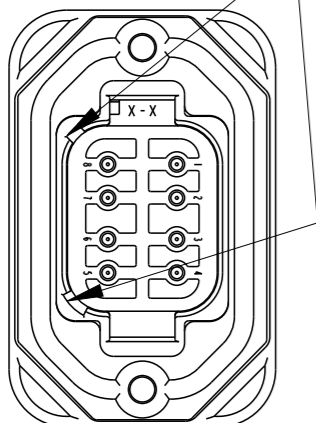

DATECODE

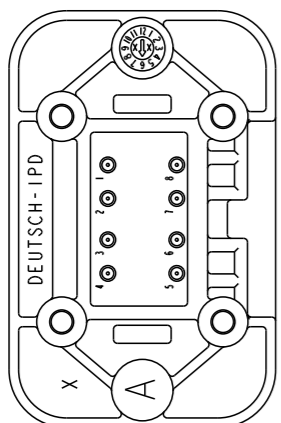

DT15-08PA  
COLOR GREY

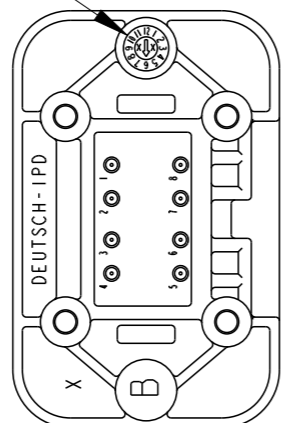

DT15-08PB  
COLOR BLACK

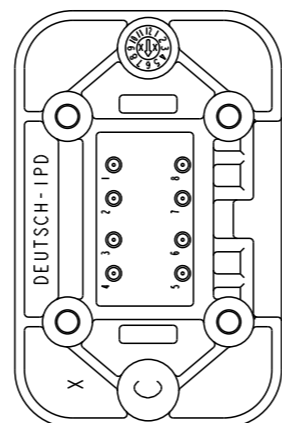

DT15-08PC  
COLOR GREEN

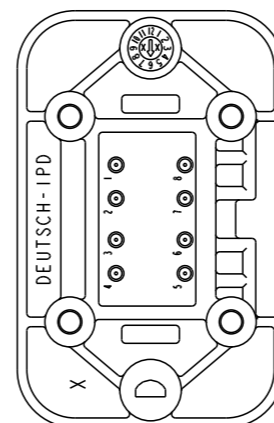

DT15-08PD  
COLOR BROWN

R.250 4X  
 $[6.35]$

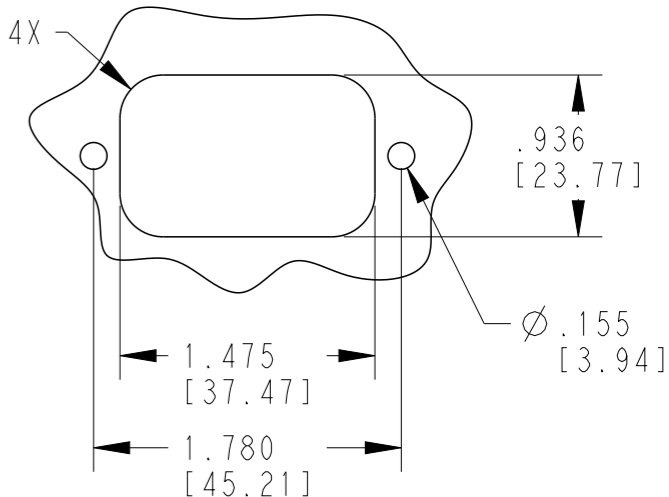

THIS DRAWING IS A CONTROLLED DOCUMENT.

DWN K. MUKESH 22AUG2022

CHK D. HEIDI 24AUG2022

APVD I. GRANTCHAROVA 25AUG2022

PRODUCT SPEC 108-151009

APPLICATION SPEC

WEIGHT 26g

CUSTOMER DRAWING



TE Connectivity

NAME  
 PCB MOUNT RECEPTACLE  
 8 PINS STRAIGHT  
 DT SERIES

SIZE A3 CAGE CODE 4AFU8 DRAWING NO. DT15-08PX-XXXX RESTRICTED TO -

SCALE 1:1 SHEET 2 OF 4 REV A

DIMENSIONS:  
 INCHES [mm]

TOLERANCES UNLESS  
 OTHERWISE SPECIFIED:

- 0 PLC ±
- 1 PLC ±
- 2 PLC ±
- 3 PLC ±
- 4 PLC ±
- ANGLES ±1°
- FINISH

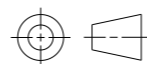

4

3

2

1

THIS DRAWING IS UNPUBLISHED.

RELEASED FOR PUBLICATION

2018

© COPYRIGHT 1994

BY TE CONNECTIVITY

ALL RIGHTS RESERVED.

REVISIONS

P	LTR	DESCRIPTION	DATE	DWN	APVD
-		SEE SHEET 1	-	-	-

G003 MODs

A KEYWAY

B KEYWAY

C KEYWAY

D KEYWAY

DATE CODE

Dimensions: 1.475 [37.47], 1.105 [28.07], R.040 4X [1.02], 2x .480 [12.19], R.100 4x [2.54], 1.780 [45.21], R.070 4X [1.78], Ø.155 2X [3.94]

Dimensions: 1.475 [37.47], .936 [23.77], 1.780 [45.21], R.250 4X [6.35], Ø.155 2X [3.94]

DT15-08PA-G003  
COLOR: GRAYDT15-08PB-G003  
COLOR: BLACKDT15-08PC-G003  
COLOR: GREENDT15-08PD-G003  
COLOR: BROWN

THIS DRAWING IS A CONTROLLED DOCUMENT.

DWN K. MUKESH 22AUG2022

CHK D. HEIDI 24AUG2022

APVD I. GRANTCHAROVA 25AUG2022

PRODUCT SPEC

108-151009

APPLICATION SPEC

WEIGHT 26g

CUSTOMER DRAWING

TE Connectivity

NAME  
PCB MOUNT RECEPTACLE  
8 PINS STRAIGHT  
DT SERIES

RESTRICTED TO

SIZE A3 CAGE CODE 4AFU8 DRAWING NO. DT15-08PX-XXXX

SCALE 1:1 SHEET 3 OF 4 REV A

DIMENSIONS:  
INCHES [mm]

TOLERANCES UNLESS  
OTHERWISE SPECIFIED:

0 PLC	±
1 PLC	±
2 PLC	±
3 PLC	±
4 PLC	±
ANGLES	±1°

MATERIAL

FINISH

1470-19 (3/13)

THIS DRAWING IS UNPUBLISHED.

RELEASED FOR PUBLICATION

2018

© COPYRIGHT 1994 BY TE CONNECTIVITY

ALL RIGHTS RESERVED.

REVISIONS

P	LTR	DESCRIPTION	DATE	DWN	APVD
	-	SEE SHEET 1	-	-	-

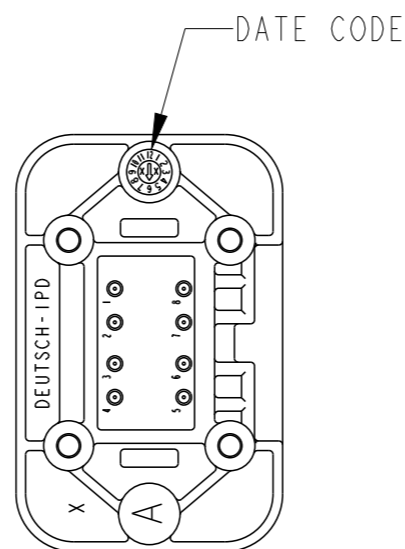
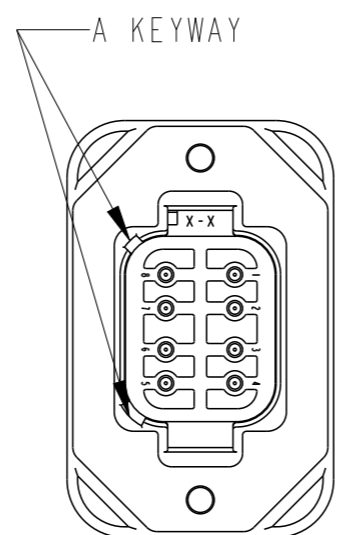

**2421632-1**  
**WITHOUT FLANGE SEAL**  
**COLOR GREY**

THIS DRAWING IS A CONTROLLED DOCUMENT.

DIMENSIONS:  
INCHES [mm]

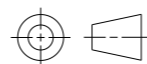

TOLERANCES UNLESS OTHERWISE SPECIFIED:

- 0 PLC ±
- 1 PLC ±
- 2 PLC ±
- 3 PLC ±
- 4 PLC ±
- ANGLES ±1°

MATERIAL

FINISH

DWN K. MUKESH 22AUG2022

CHK D. HEIDI 24AUG2022

APVD I. GRANTCHAROVA 25AUG2022

PRODUCT SPEC  
108-151009

APPLICATION SPEC

WEIGHT 26g

CUSTOMER DRAWING



NAME  
 PCB MOUNT RECEPTACLE  
 8 PINS STRAIGHT  
 DT SERIES

SIZE	CAGE CODE	DRAWING NO	RESTRICTED TO
------	-----------	------------	---------------

A3	4AFU8	DT15-08PX-XXXX	-
----	-------	----------------	---

SCALE 1:1	SHEET 4 OF 4	REV A
-----------	--------------	-------