

LOC		DIST		REVISIONS			
AD	00	P	LT#	DESCRIPTION	DATE	DWN	APVD
		B		REVISED PER ECO-11-025276	04JAN2012	KH	DY

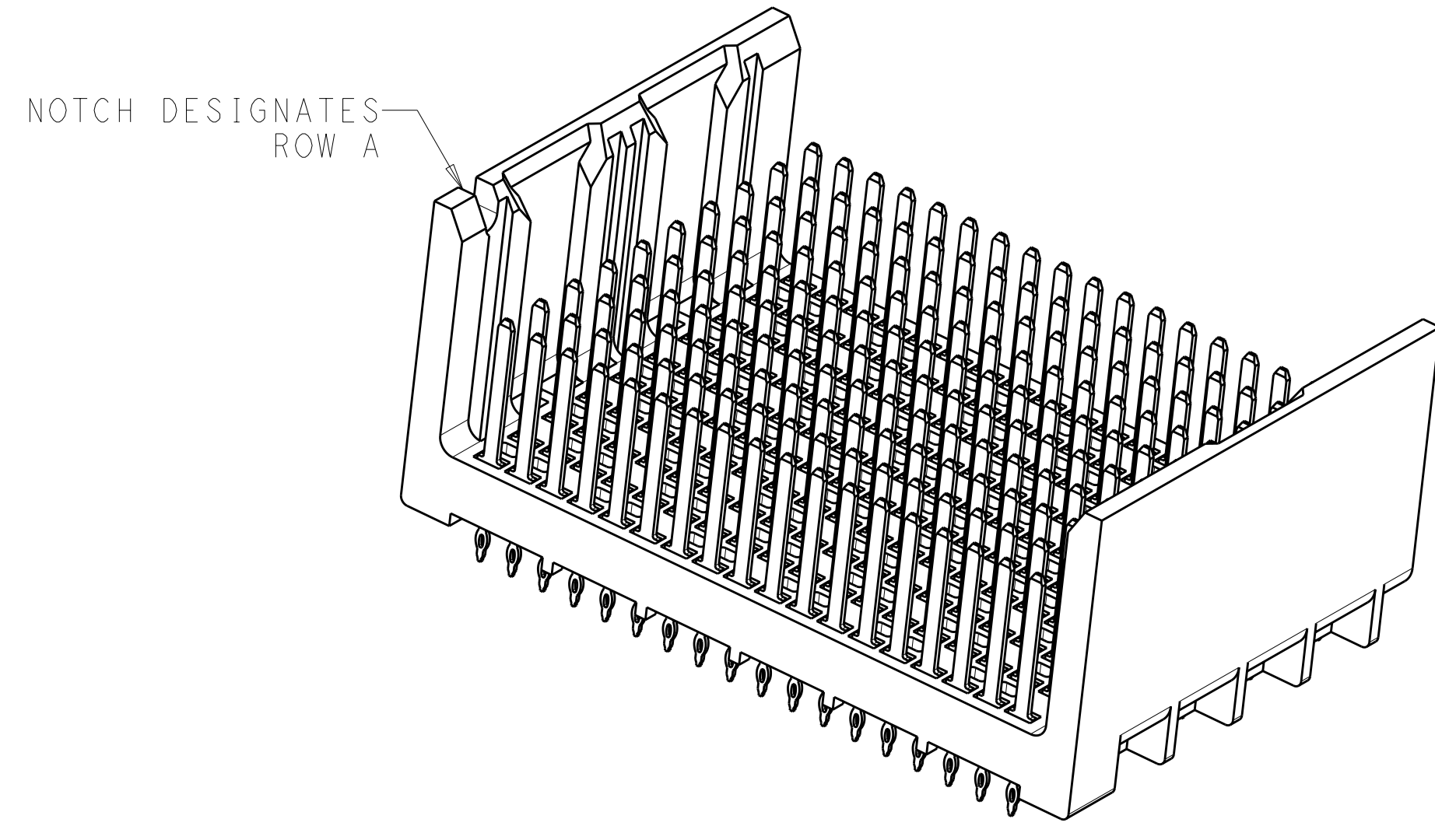

- 1 MATERIAL:
HOUSING: LCP, GLASS FILLED, UL94V-0.
TERMINALS: HIGH PERFORMANCE COPPER ALLOY.
- 2 FINISH:
30µ" MIN GOLD IN CONTACT AREA. SELECTIVE TIN
ON PCB TAILS, NICKEL OVERALL.
- 3 FINISH:
30µ" MIN GOLD IN CONTACT AREA. SELECTIVE TIN-LEAD
ON PCB TAILS, NICKEL OVERALL.

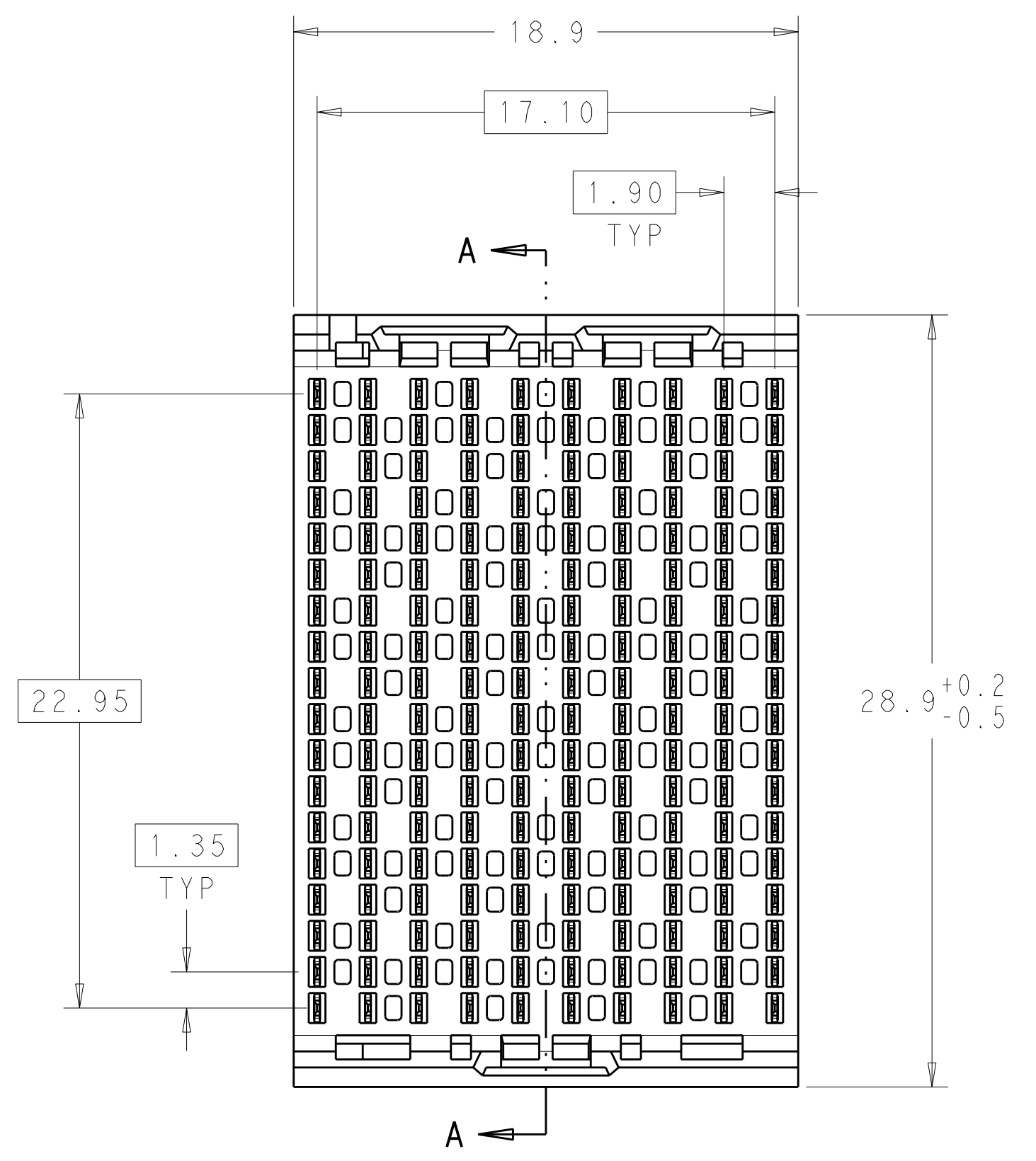
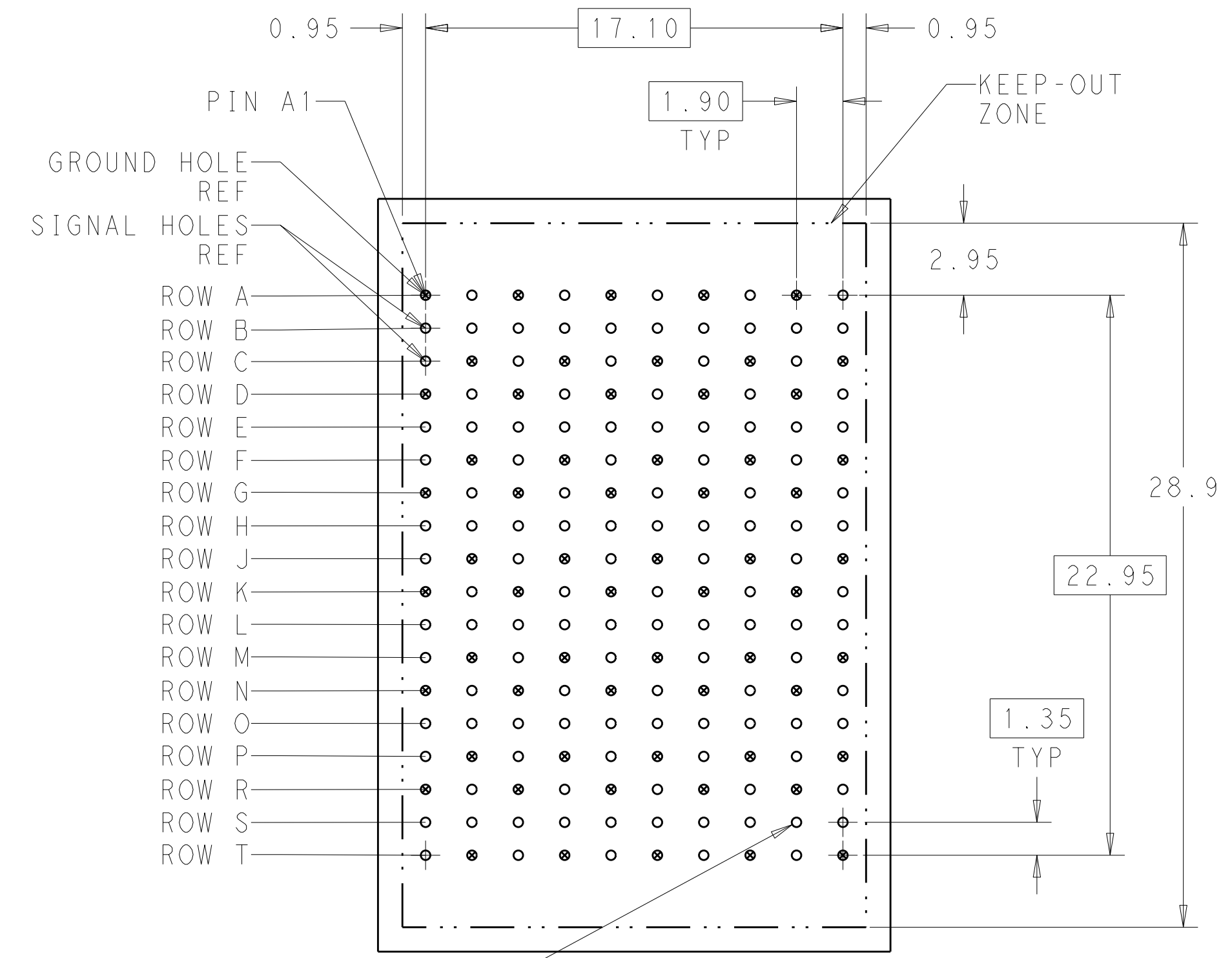

180X Ø0.39±0.05
 Ⓢ Ø0.10
 PLATED THRU HOLE

UNGUIDED
 BACKPLANE HOLE PATTERN
 (CONNECTOR SIDE)

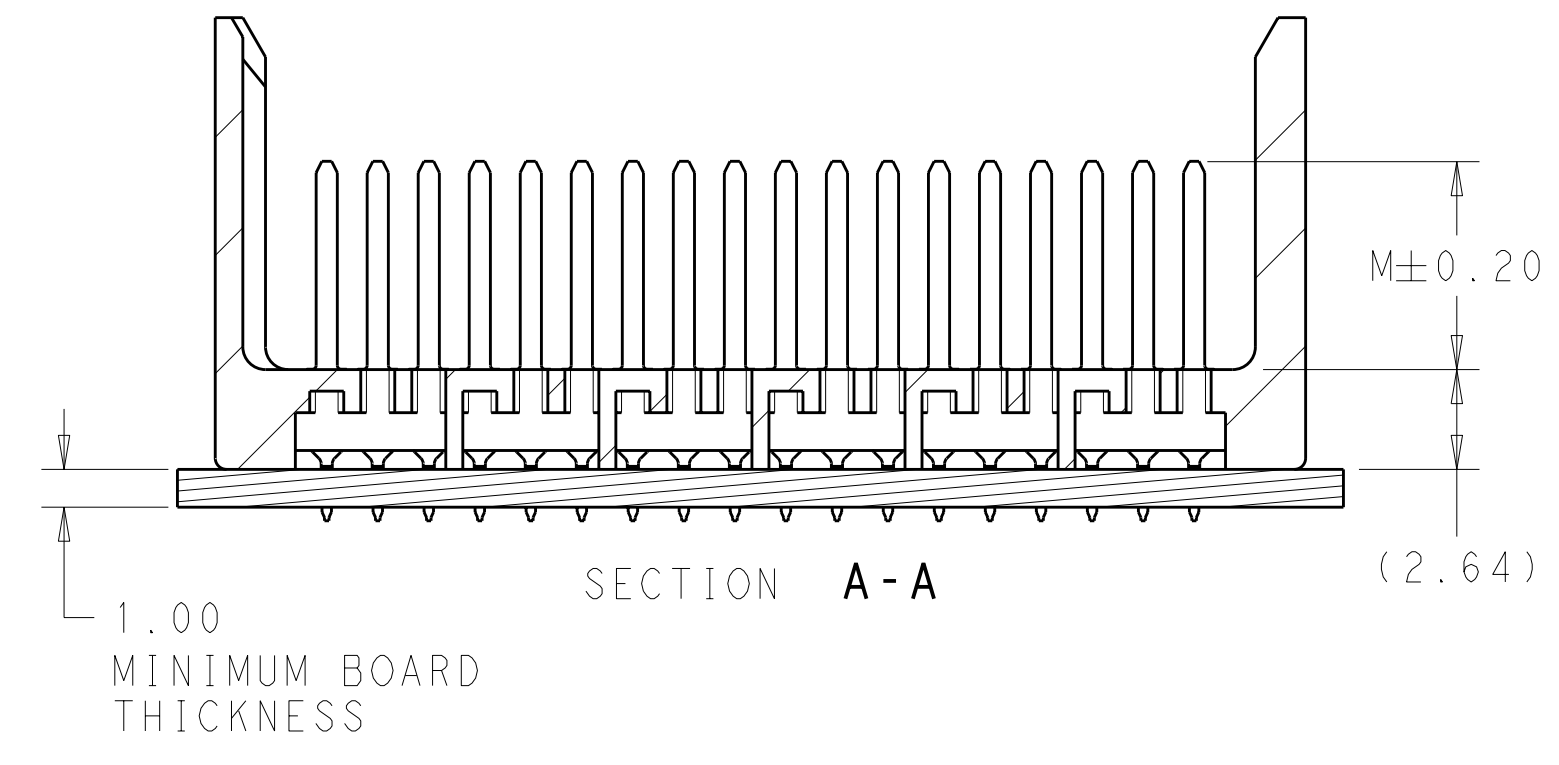
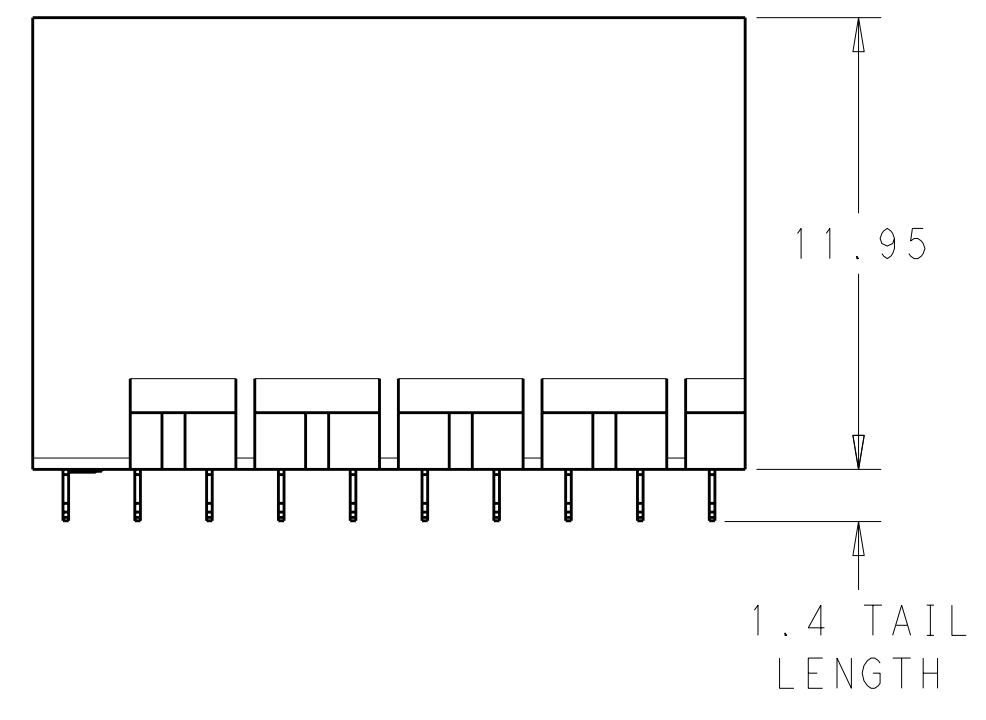

THIS DRAWING IS A CONTROLLED DOCUMENT.		DWN J. K. SHOBER 25JAN2011	TE Connectivity
DIMENSIONS: mm		CHK J. EBY 25JAN2011	
TOLERANCES UNLESS OTHERWISE SPECIFIED:		APVD J. EBY 25JAN2011	NAME IMPACT, 6 PAIR, 10 COLUMN, HEADER
0 PLC ±		PRODUCT SPEC	UNGUIDED, OPEN END WALL
1 PLC ±0.25		APPLICATION SPEC	SIGNAL MODULE, 0.39 PTH
2 PLC ±0.13		SIZE CAGE CODE DRAWING NO	RESTRICTED TO
3 PLC ±		WEIGHT	A100779C=2007884
4 PLC ±		CUSTOMER DRAWING	SCALE 5:1 SHEET 1 OF 2 REV B
ANGLES ±			
FINISH SEE TABLE			

THIS DRAWING IS UNPUBLISHED. RELEASED FOR PUBLICATION 20
 © COPYRIGHT 20 . . . ALL RIGHTS RESERVED.

LOC	DIST	REVISIONS					
AD	00	P	LTB	DESCRIPTION	DATE	DWN	APVD
		-	-	SEE SHEET 1	-	-	-

FINISH	DIM M	PART NUMBER
\triangle_3	5.5	2007884-6
\triangle_3	4.9	2007884-5
\triangle_3	4.5	2007884-4
\triangle_2	5.5	2007884-3
\triangle_2	4.9	2007884-2
\triangle_2	4.5	2007884-1

REFER TO WWW.TE.COM
FOR PRODUCT AVAILABILITY

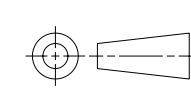
THIS DRAWING IS A CONTROLLED DOCUMENT.		DWN J. K. SHOBER 25JAN2011		
DIMENSIONS: mm		CHK J. EABY 25JAN2011		
		TOLERANCES UNLESS OTHERWISE SPECIFIED: 9 PLC ± 7 PLC ±0.25 5 PLC ±0.13 4 PLC ± ANGLES ± FINISH ±		NAME IMPACT, 6 PAIR, 10 COLUMN, HEADER UNGUIDED, OPEN END WALL SIGNAL MODULE, 0.39 PTH
MATERIAL -		APVD J. EABY 25JAN2011 PRODUCT SPEC APPLICATION SPEC WEIGHT CUSTOMER DRAWING		SIZE CAGE CODE DRAWING NO A100779C=2007884 RESTRICTED TO -
		SCALE 5:1		SHEET 2 OF 2
				REV B