

Data sheet | Item number: 2020-115

1-conductor female connector; Push-in CAGE CLAMP®; 1.5 mm<sup>2</sup>; Pin spacing 3.5 mm; 15-pole; 1,50 mm<sup>2</sup>; gray

[www.wago.com/2020-115](http://www.wago.com/2020-115)

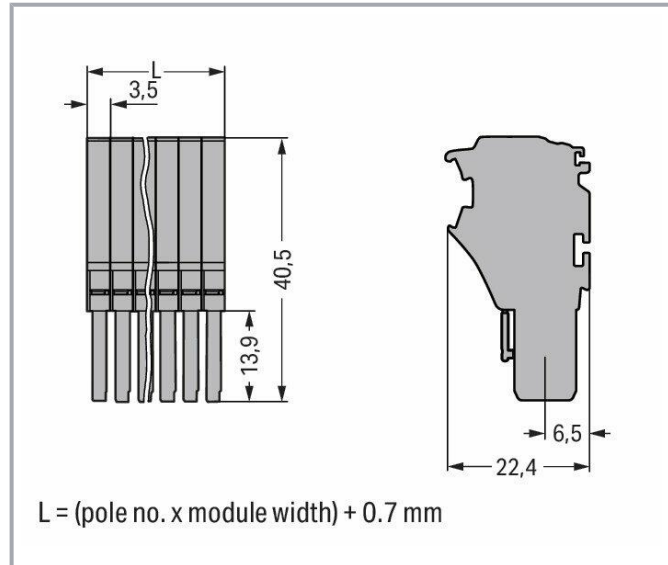
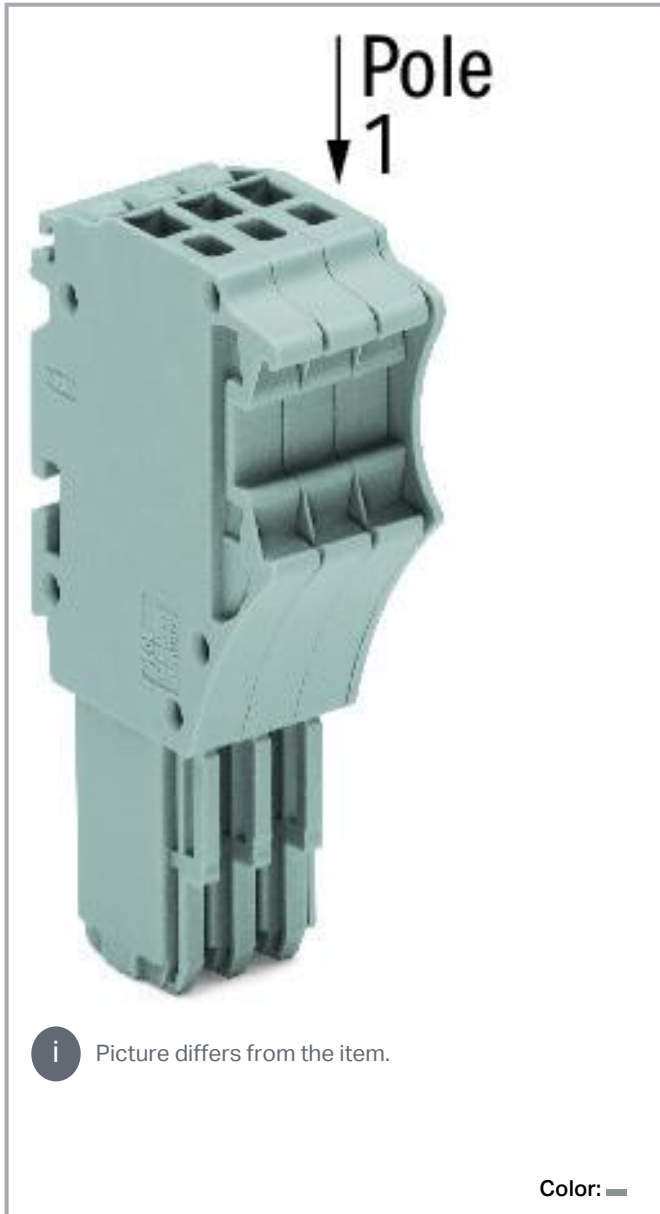

Subject to changes. Please also observe the further product documentation!

WAGO GmbH & Co. KG  
Hansastr. 27  
32423 Minden  
Phone: +49571 887-0 | Fax: +49571 887-169  
Email: [info.de@wago.com](mailto:info.de@wago.com) | Web: [www.wago.com](http://www.wago.com)

Do you have any questions about our products?  
We are always happy to take your call at +49 (571) 887-44222.



## Data

### Notes

Safety information

According to EN 61984, pluggable connectors without current interrupting capacity must not be mated or unmated when live or under load.

Safety information 2

Notice: An appropriate end plate must be applied to the carrier terminal blocks after each female plug.

## Electrical data

### Ratings per IEC/EN

| Ratings per                   | IEC/EN 61984                                              |
|-------------------------------|-----------------------------------------------------------|
| Nominal voltage (III/3)       | 500 V                                                     |
| Rated impulse voltage (III/3) | 6 kV                                                      |
| Rated current                 | 13.5 A                                                    |
| Legend (ratings)              | (III / 3) ≙ Overvoltage category III / Pollution degree 3 |

### Ratings per UL 1059

| Approvals per                  | UL 1059 |
|--------------------------------|---------|
| Rated voltage UL (Use Group B) | 300 V   |
| Rated current UL (Use Group B) | 15 A    |
| Rated voltage UL (Use Group C) | 300 V   |
| Rated current UL (Use Group C) | 15 A    |
| Rated voltage UL (Use Group D) | 300 V   |
| Rated current UL (Use Group D) | 15 A    |

### Ratings per CSA

| Approvals per                   | CSA 22.2 No 158 |
|---------------------------------|-----------------|
| Rated voltage CSA (Use Group B) | 300 V           |
| Rated current CSA (Use Group B) | 10 A            |
| Rated voltage CSA (Use Group C) | 300 V           |
| Rated current CSA (Use Group C) | 10 A            |
| Rated voltage CSA (Use Group D) | 300 V           |
| Rated current CSA (Use Group D) | 10 A            |

Subject to changes. Please also observe the further product documentation!

WAGO GmbH & Co. KG

Hansastr. 27

32423 Minden

Phone: +49571 887-0 | Fax: +49571 887-169

Email: [info.de@wago.com](mailto:info.de@wago.com) | Web: [www.wago.com](http://www.wago.com)

Do you have any questions about our products?

We are always happy to take your call at +49 (571) 887-44222.



## Connection data

|                            |    |
|----------------------------|----|
| Connection points          | 15 |
| Total number of potentials | 15 |

## Connection 1

|                                                            |                                                                                                                                   |
|------------------------------------------------------------|-----------------------------------------------------------------------------------------------------------------------------------|
| Connection technology                                      | Push-in CAGE CLAMP®                                                                                                               |
| Actuation type                                             | Operating tool                                                                                                                    |
| Connectable conductor materials                            | Copper                                                                                                                            |
| Nominal cross-section                                      | 1 mm <sup>2</sup>                                                                                                                 |
| Solid conductor                                            | 0.14 ... 1.5 mm <sup>2</sup> / 24 ... 16 AWG                                                                                      |
| Solid conductor; push-in termination                       | 0.5 ... 1.5 mm <sup>2</sup> / 20 ... 16 AWG                                                                                       |
| Fine-stranded conductor                                    | 0.14 ... 1.5 mm <sup>2</sup> / 24 ... 16 AWG                                                                                      |
| Fine-stranded conductor; with insulated ferrule            | 0.14 ... 0.75 mm <sup>2</sup> / 24 ... 18 AWG                                                                                     |
| Fine-stranded conductor; with ferrule; push-in termination | 0.5 ... 0.75 mm <sup>2</sup> / 20 ... 18 AWG                                                                                      |
| Note (conductor cross-section)                             | Depending on the conductor characteristic, a conductor with a smaller cross-section can also be inserted via push-in termination. |
| Strip length                                               | 9 ... 11 mm / 0.35 ... 0.43 inches                                                                                                |
| Pole number                                                | 15                                                                                                                                |
| Wiring direction                                           | Front-entry wiring                                                                                                                |

## Physical data

|              |                        |
|--------------|------------------------|
| Width        | 53.2 mm / 2.094 inches |
| Height       | 40.5 mm / 1.594 inches |
| Depth        | 22.4 mm / 0.882 inches |
| Module width | 3.5 mm / 0.138 inches  |

## Mechanical Data

|                          |              |
|--------------------------|--------------|
| Variable coding          | Yes          |
| Marking level            | Side marking |
| Anti-rotation protection | Yes          |

## Plug-in connection

|                                    |                         |
|------------------------------------|-------------------------|
| Contact type (pluggable connector) | Female connector/socket |
| Connector (connection type)        | for conductor           |
| Mismating protection               | No                      |

Subject to changes. Please also observe the further product documentation!



|                                      |    |
|--------------------------------------|----|
| Plugging without loss of pin spacing | No |
|--------------------------------------|----|

## Material Data

Note (material data)

Information on material specifications can be found here

|                             |                  |
|-----------------------------|------------------|
| Color                       | gray             |
| Material group              | I                |
| Insulation material         | Polyamide (PA66) |
| Flammability class per UL94 | V0               |
| Fire load                   | 0.598 MJ         |
| Weight                      | 33.8 g           |

## Environmental requirements

|                                  |                 |
|----------------------------------|-----------------|
| Processing temperature           | -35 ... +85 °C  |
| Continuous operating temperature | -60 ... +105 °C |

## Commercial data

|                       |               |
|-----------------------|---------------|
| eCl@ss 10.0           | 27-14-11-06   |
| eCl@ss 9.0            | 27-14-11-06   |
| ETIM 8.0              | EC001284      |
| ETIM 7.0              | EC001284      |
| PU (SPU)              | 10 pcs        |
| Packaging type        | Box           |
| Country of origin     | CN            |
| GTIN                  | 4050821245124 |
| Customs tariff number | 85366990990   |

## Environmental Product Compliance

|                        |                         |
|------------------------|-------------------------|
| RoHS Compliance Status | Compliant, No Exemption |
|------------------------|-------------------------|

## Approvals / Certificates

### General approvals

| Logo | Approval                        | Additional Approval Text | Certificate name |
|------|---------------------------------|--------------------------|------------------|
|      | CCA<br>DEKRA Certification B.V. | EN 60947                 | NTR NL<br>7617   |

Subject to changes. Please also observe the further product documentation!

WAGO GmbH & Co. KG  
 Hansastr. 27  
 32423 Minden  
 Phone: +49571 887-0 | Fax: +49571 887-169  
 Email: [info.de@wago.com](mailto:info.de@wago.com) | Web: [www.wago.com](http://www.wago.com)

Do you have any questions about our products?  
 We are always happy to take your call at +49 (571) 887-44222.

CCA



CSA  
DEKRA Certification B.V.

C22.2

2516073



UL  
UL International Germany GmbH



UL 1059

E 45172

## Declarations of conformity and manufacturer's declarations

| Logo                                                                              | Approval                                           | Additional Approval Text | Certificate name |
|-----------------------------------------------------------------------------------|----------------------------------------------------|--------------------------|------------------|
|   | EU-Declaration of Conformity<br>WAGO GmbH & Co. KG | -                        | -                |
|  | UK-Declaration of Conformity<br>WAGO GmbH & Co. KG | -                        | -                |

## Approvals for marine applications

| Logo                                                                                | Approval                           | Additional Approval Text | Certificate name         |
|-------------------------------------------------------------------------------------|------------------------------------|--------------------------|--------------------------|
|   | ABS<br>American Bureau of Shipping | EN 60947                 | 20-<br>HG1941090-<br>PDA |
|  | BV<br>Bureau Veritas S.A.          | EN 60947                 | 38586/BO<br>BV           |
|  | LR<br>Lloyds Register              | EN 60947                 | 91/20112<br>(E9)         |











## Optional accessories

## Tool







Subject to changes. Please also observe the further product documentation!

WAGO GmbH & Co. KG  
Hansastr. 27  
32423 Minden  
Phone: +49571 887-0 | Fax: +49571 887-169  
Email: [info.de@wago.com](mailto:info.de@wago.com) | Web: [www.wago.com](http://www.wago.com)

Do you have any questions about our products?  
We are always happy to take your call at +49 (571) 887-44222.

| Operating tool                                                                     |                                                                                                                                                                                            |                                                                  |
|------------------------------------------------------------------------------------|--------------------------------------------------------------------------------------------------------------------------------------------------------------------------------------------|------------------------------------------------------------------|
|    | <b>Item no.: 210-648</b><br>Operating tool; Blade: 2.5 x 0.4 mm; with a partially insulated shaft; angled; short                                                                           | <a href="http://www.wago.com/210-648">www.wago.com/210-648</a>   |
|    | <b>Item no.: 210-647</b><br>Operating tool; Blade: 2.5 x 0.4 mm; with a partially insulated shaft; multicoloured                                                                           | <a href="http://www.wago.com/210-647">www.wago.com/210-647</a>   |
|    | <b>Item no.: 210-719</b><br>Operating tool; Blade: 2.5 x 0.4 mm; with a partially insulated shaft                                                                                          | <a href="http://www.wago.com/210-719">www.wago.com/210-719</a>   |
| Ferrule                                                                            |                                                                                                                                                                                            |                                                                  |
| Ferrule                                                                            |                                                                                                                                                                                            |                                                                  |
|     | <b>Item no.: 216-241</b><br>Ferrule; Sleeve for 0.5 mm <sup>2</sup> / 20 AWG; insulated; electro-tin plated; electrolytic copper; gastight crimped; acc. to DIN 46228, Part 4/09.90; white | <a href="http://www.wago.com/216-241">www.wago.com/216-241</a>   |
|     | <b>Item no.: 216-242</b><br>Ferrule; Sleeve for 0.75 mm <sup>2</sup> / 18 AWG; insulated; electro-tin plated; electrolytic copper; gastight crimped; acc. to DIN 46228, Part 4/09.90; gray | <a href="http://www.wago.com/216-242">www.wago.com/216-242</a>   |
|     | <b>Item no.: 216-243</b><br>Ferrule; Sleeve for 1 mm <sup>2</sup> / AWG 18; insulated; electro-tin plated; electrolytic copper; gastight crimped; acc. to DIN 46228, Part 4/09.90; red     | <a href="http://www.wago.com/216-243">www.wago.com/216-243</a>   |
| Locking levers                                                                     |                                                                                                                                                                                            |                                                                  |
| Locking system                                                                     |                                                                                                                                                                                            |                                                                  |
|  | <b>Item no.: 2022-151</b><br>Locking lever; gray                                                                                                                                           | <a href="http://www.wago.com/2022-151">www.wago.com/2022-151</a> |
|  | <b>Item no.: 2022-152</b><br>Locking lever; orange                                                                                                                                         | <a href="http://www.wago.com/2022-152">www.wago.com/2022-152</a> |
| Protective warning marker                                                          |                                                                                                                                                                                            |                                                                  |
| Cover                                                                              |                                                                                                                                                                                            |                                                                  |
|  | <b>Item no.: 2000-115</b><br>Protective warning marker; for 5 terminal blocks; with high-voltage symbol, black; yellow                                                                     | <a href="http://www.wago.com/2000-115">www.wago.com/2000-115</a> |
| Strain relief                                                                      |                                                                                                                                                                                            |                                                                  |
| Strain relief plate                                                                |                                                                                                                                                                                            |                                                                  |
|  | <b>Item no.: 734-326</b><br>Strain relief plate; for female and male connectors; 35 mm wide; 1 part; gray                                                                                  | <a href="http://www.wago.com/734-326">www.wago.com/734-326</a>   |
| Marking accessories                                                                |                                                                                                                                                                                            |                                                                  |
| Marking strip                                                                      |                                                                                                                                                                                            |                                                                  |
|  | <b>Item no.: 2009-110</b><br>Marking strips; for Smart Printer; on reel; not stretchable; plain; snap-on type; white                                                                       | <a href="http://www.wago.com/2009-110">www.wago.com/2009-110</a> |

Subject to changes. Please also observe the further product documentation!

|                                                                                  |                                                                                                             |                                                                  |
|----------------------------------------------------------------------------------|-------------------------------------------------------------------------------------------------------------|------------------------------------------------------------------|
|  | <b>Item no.: 210-831</b><br>Marking strips; on reel; 2.3 mm wide; plain; Self-adhesive; white               | <a href="http://www.wago.com/210-831">www.wago.com/210-831</a>   |
|  | <b>Item no.: 210-833</b><br>Marking strips; 25 m on roll; 6 mm wide; plain; Self-adhesive; white            | <a href="http://www.wago.com/210-833">www.wago.com/210-833</a>   |
|  | <b>Item no.: 210-834</b><br>Marking strips; on reel; 5 mm wide; plain; Self-adhesive; white                 | <a href="http://www.wago.com/210-834">www.wago.com/210-834</a>   |
|  | <b>Item no.: 210-832</b><br>Marking strips; on reel; 3 mm wide; plain; Self-adhesive; white                 | <a href="http://www.wago.com/210-832">www.wago.com/210-832</a>   |
| <b>Marker</b>                                                                    |                                                                                                             |                                                                  |
|  | <b>Item no.: 2009-113</b><br>WMB-Inline; for Smart Printer; 2300 pieces on roll; plain; snap-on type; white | <a href="http://www.wago.com/2009-113">www.wago.com/2009-113</a> |
|  | <b>Item no.: 793-3501</b><br>WMB marking card; as card; plain; snap-on type; white                          | <a href="http://www.wago.com/793-3501">www.wago.com/793-3501</a> |

## Downloads

### Documentation

#### Bid Text

|                          |             |                 |          |
|--------------------------|-------------|-----------------|----------|
| 2020-115<br>X81 - Datei  | 2019 Feb 19 | xml<br>4.0 kB   | Download |
| 2020-115<br>docx - Datei | 2018 Aug 6  | docx<br>15.4 kB | Download |

#### Additional Information

|                                             |               |          |
|---------------------------------------------|---------------|----------|
| Technical Section<br>Technical explanations | pdf<br>2.2 MB | Download |
|---------------------------------------------|---------------|----------|

### CAD/CAE-Data

#### CAD data

|                       |     |          |
|-----------------------|-----|----------|
| 2D/3D Models 2020-115 | URL | Download |
|-----------------------|-----|----------|

#### CAE data

EPLAN Data Portal 2020-115

Subject to changes. Please also observe the further product documentation!

|                         |                     |                          |
|-------------------------|---------------------|--------------------------|
|                         | <a href="#">URL</a> | <a href="#">Download</a> |
| WSCAD Universe 2020-115 | <a href="#">URL</a> | <a href="#">Download</a> |
| ZUKEN Portal 2020-115   | <a href="#">URL</a> | <a href="#">Download</a> |

## Environmental Product Compliance

### Compliance Search

|                                                                                                                                   |                     |                          |
|-----------------------------------------------------------------------------------------------------------------------------------|---------------------|--------------------------|
| Environmental Product Compliance 2020-115                                                                                         | <a href="#">URL</a> | <a href="#">Download</a> |
| 1-conductor female connector; Push-in CAGE CLAMP®; 1.5 mm <sup>2</sup> ; Pin spacing 3.5 mm; 15-pole; 1,50 mm <sup>2</sup> ; gray |                     |                          |

## Installation Notes

### Coding

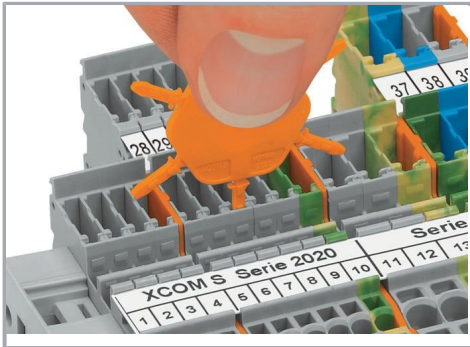

Insert coding pin into the corresponding slot and twist it off.



Coding a female plug: remove coding finger using a suitable tool.

Subject to changes. Please also observe the further product documentation!



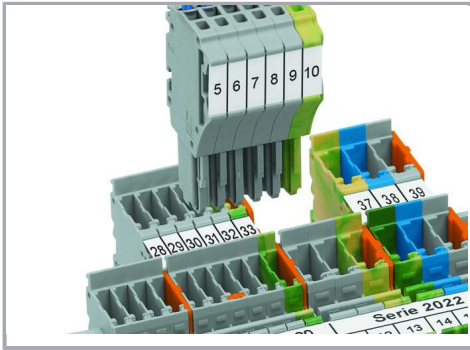

Insert coded female plug into X-COM®S-SYSTEM terminal block assembly.

### Locking system

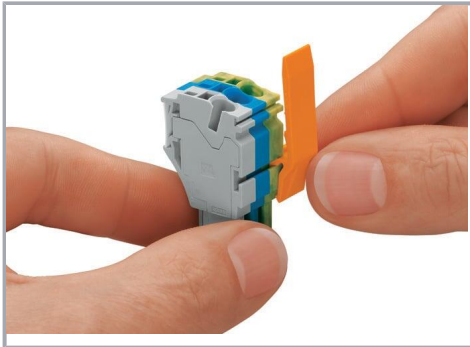

Slide the locking lever into position.

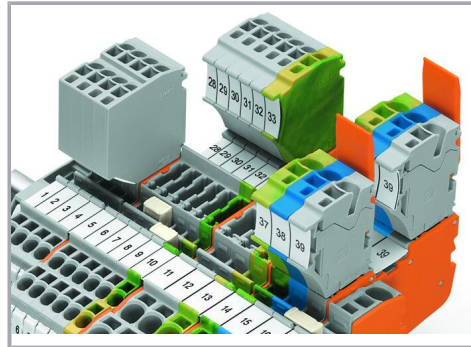

Female plugs can be individually locked.

### Product family

**X-COM S-Mini**

[Show all products from the family](#)

Subject to changes. Please also observe the further product documentation!