

TOLERANCE UNLESS OTHERWISE SPECIFIED	
.X	±0.25
.XX	±0.13
.XXX	±0.05

THIS IS A C.A.D. GENERATED DRAWING  
DO NOT MAKE MANUAL REVISIONS TO MASTER.

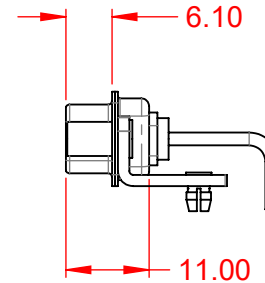

ISSUE NUMBER	
ORIGINAL	①

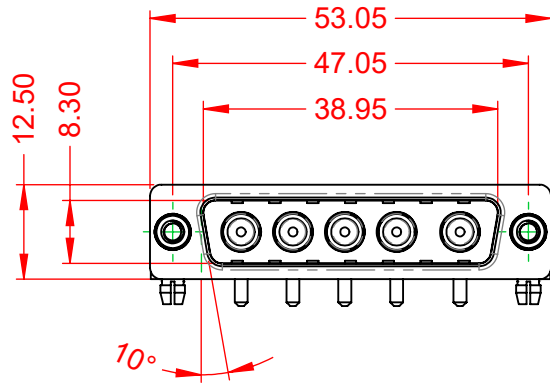

**NOTES:**

**MATERIAL:**  
**HOUSING:** THERMOPLASTIC POLYESTER, UL94V-0  
**SHELL:** STEEL, TIN PLATED  
**CONTACT:** COPPER ALLOY, 30µ" GOLD PLATED

**OPERATING TEMPERATURE:** -55°C ~ 125°C

**POWER/CO-AX CONTACT RATING:** 10A (CURRENT)  
(IF PRESENT)

**SIGNAL CONTACT CURRENT RATING:** 5A PER CONTACT

**SIGNAL CONTACT RESISTANCE:** 10mΩ MAX.

**INSULATOR RESISTANCE:** 5000MΩ min.

**DIELECTRIC WITHSTANDING VOLTAGE:** 1000V AC rms

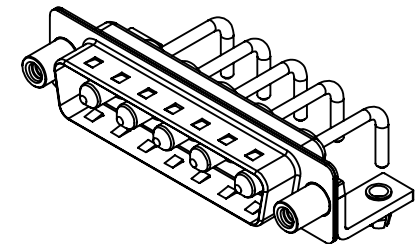
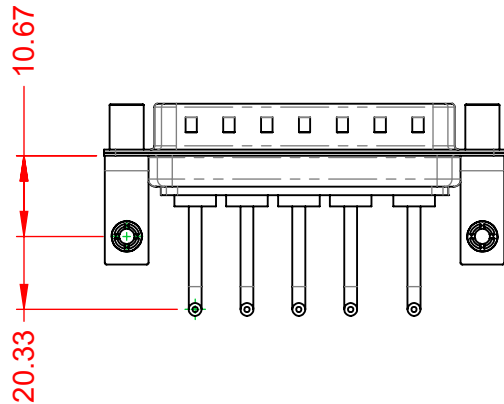

THIS SERIES FULLY CONFORMS TO  
THE EUROPEAN UNION DIRECTIVES  
2011/65/EU FOR RoHS COMPLIANCY.



YOUR CONNECTION TO QUALITY & SERVICE

EDAC INC  
TORONTO, ONTARIO  
CANADA

THESE DRAWINGS AND SPECIFICATIONS  
ARE THE PROPERTY OF EDAC INC., AND  
SHALL NOT BE REPRODUCED, OR COPIED  
OR USED AS THE BASIS FOR THE  
MANUFACTURE OR SALE OF APPARATUS  
WITHOUT WRITTEN PERMISSION.

**COMBINATION D-SUB**

SW REFERENCE NO.: 629 COMBO ASSEMBLY	
DRAWN: C.B	DATE: JAN. 01/2019
CHECKED:	DATE:
SCALE: (IN C.A.D. 1:1)	SHEET 1 OF 2
DRAWING NUMBER: 629-5W5-650-1T5	ISSUE
PART NUMBER: 629-5W5-650-1T5	1

TOLERANCE UNLESS OTHERWISE SPECIFIED	
.X	±0.25
.XX	±0.13
.XXX	±0.05

THIS IS A C.A.D. GENERATED DRAWING  
DO NOT MAKE MANUAL REVISIONS TO MASTER.



ISSUE NUMBER	
ORIGINAL	①



<b>COMBINATION D-SUB</b>		SW REFERENCE NO.: 629 COMBO ASSEMBLY	
		DRAWN: C.B	DATE: JAN. 01/2019
<b>EDAC</b> TORONTO, ONTARIO CANADA YOUR CONNECTION TO QUALITY & SERVICE		CHECKED:	DATE:
		SCALE: N.T.S	SHEET 2 OF 2
THESE DRAWINGS AND SPECIFICATIONS ARE THE PROPERTY OF EDAC INC., AND SHALL NOT BE REPRODUCED, OR COPIED OR USED AS THE BASIS FOR THE MANUFACTURE OR SALE OF APPARATUS WITHOUT WRITTEN PERMISSION.			DRAWING NUMBER: 629-5W5-650-1T5
			PART NUMBER: 629-5W5-650-1T5
			ISSUE 1



THIS SERIES FULLY CONFORMS TO  
THE EUROPEAN UNION DIRECTIVES  
2011/65/EU FOR RoHS COMPLIANCY.