

Data sheet | Item number: 870-911

2-conductor through terminal block; 2.5 mm<sup>2</sup>; side and center marking; for DIN-15 rail; CAGE CLAMP®; 2,50 mm<sup>2</sup>; gray

[www.wago.com/870-911](http://www.wago.com/870-911)

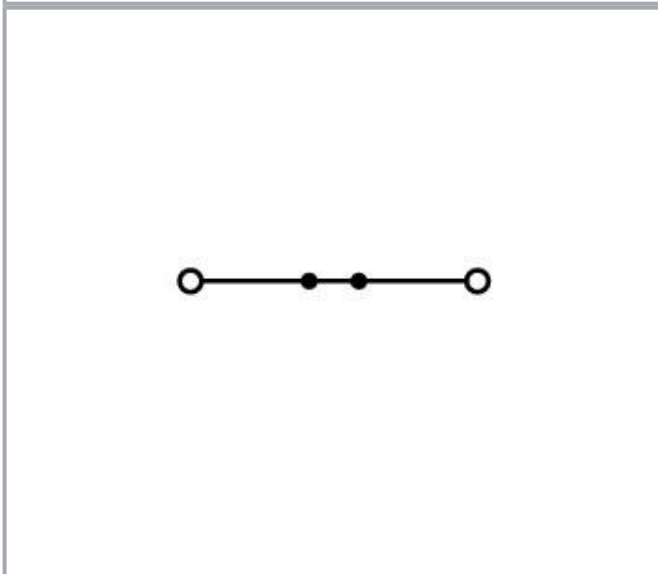
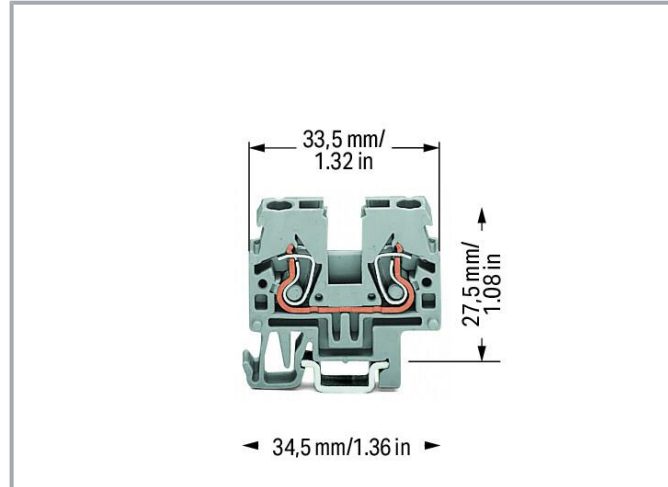

Subject to changes. Please also observe the further product documentation!

WAGO GmbH & Co. KG  
Hansastr. 27  
32423 Minden  
Phone: +49571 887-0 | Fax: +49571 887-169  
Email: [info.de@wago.com](mailto:info.de@wago.com) | Web: [www.wago.com](http://www.wago.com)

Do you have any questions about our products?  
We are always happy to take your call at +49 (571) 887-44222.

**Data****Notes**

Safety information

Max. insulation diameter: 4.4 mm

**Electrical data****Ratings per IEC/EN**

Ratings per	IEC/EN 60947-7-1
Nominal voltage (III/3)	500 V
Rated impulse voltage (III/3)	6 kV
Rated current	24 A
Legend (ratings)	(III / 3) ≙ Overvoltage category III / Pollution degree 3

**Power loss**

Power loss, per pole (potential)	0.766 W
Rated current $I_N$ for specified power loss	24 A
Resistance value for specified, current-dependent power loss	0.001 $\Omega$

**Connection data**

Connection points	2
Total number of potentials	1
Number of levels	1

**Connection 1**

Connection technology	CAGE CLAMP®
Actuation type	Operating tool
Connectable conductor materials	Copper
Solid conductor	0.08 ... 2.5 mm <sup>2</sup> / 28 ... 12 AWG
Fine-stranded conductor	0.08 ... 4 mm <sup>2</sup> / 28 ... 12 AWG
Fine-stranded conductor; with insulated ferrule	0.08 ... 1.5 mm <sup>2</sup> / 28 ... 14 AWG
Strip length	6 ... 7 mm / 0.24 ... 0.28 inches
Wiring direction	Front-entry wiring

Subject to changes. Please also observe the further product documentation!

WAGO GmbH &amp; Co. KG

Hansastr. 27

32423 Minden

Phone: +49571 887-0 | Fax: +49571 887-169

Email: [info.de@wago.com](mailto:info.de@wago.com) | Web: [www.wago.com](http://www.wago.com)

Do you have any questions about our products?

We are always happy to take your call at +49 (571) 887-44222.



## Physical data

Width	5 mm / 0.197 inches
Height	34.5 mm / 1.358 inches
Depth from upper-edge of DIN-rail	26.5 mm / 1.043 inches

## Mechanical Data

Design	horizontal type
Mounting type	DIN-15 rail
Marking level	Side marking

## Material Data

Note (material data)	Information on material specifications can be found here
Color	gray
Material group	I
Insulation material	Polyamide (PA66)
Flammability class per UL94	V0
Fire load	0.084 MJ
Weight	4 g

## Environmental requirements

Processing temperature	-35 ... +85 °C
Continuous operating temperature	-60 ... +105 °C

## Commercial data

Product Group	16 (Rail Mounted Terminal Blocks with CCC)
eCl@ss 10.0	27-14-11-20
eCl@ss 9.0	27-14-11-20
ETIM 8.0	EC000897
ETIM 7.0	EC000897
PU (SPU)	100 pcs
Packaging type	box
Country of origin	DE
GTIN	4044918478458

Subject to changes. Please also observe the further product documentation!



Customs tariff number	85369010000
-----------------------	-------------

## Environmental Product Compliance



RoHS Compliance Status	Compliant, No Exemption
------------------------	-------------------------

## Approvals / Certificates

### General approvals

Logo	Approval	Additional Approval Text	Certificate name
	CCA DEKRA Certification B.V.	EN 60947	NTR NL 7468
	CCA DEKRA Certification B.V.	EN 60947	2189801.01
	cURus UL International Germany GmbH	UL 1059	E45172

### Declarations of conformity and manufacturer's declarations

Logo	Approval	Additional Approval Text	Certificate name
	EU-Declaration of Conformity WAGO GmbH & Co. KG	-	-
	UK-Declaration of Conformity WAGO GmbH & Co. KG	-	-

### Approvals for marine applications

Logo	Approval	Additional Approval Text	Certificate name
	ABS American Bureau of Shipping	-	20- HG1941090- PDA
	DNV GL	-	TAE00001V2

Subject to changes. Please also observe the further product documentation!

WAGO GmbH & Co. KG  
 Hansastr. 27  
 32423 Minden  
 Phone: +49571 887-0 | Fax: +49571 887-169  
 Email: [info.de@wago.com](mailto:info.de@wago.com) | Web: [www.wago.com](http://www.wago.com)

Do you have any questions about our products?  
 We are always happy to take your call at +49 (571) 887-44222.



Det Norske Veritas, Germanischer Lloyd

## Required accessories

### End plate

End plate



**Item no.: 870-923**  
End and intermediate plate; 2 mm thick; gray

[www.wago.com/870-923](http://www.wago.com/870-923)



**Item no.: 870-924**  
End and intermediate plate; 2 mm thick; orange

[www.wago.com/870-924](http://www.wago.com/870-924)

## Optional accessories

### End plate

End plate



**Item no.: 870-928**  
Separator plate; 2 mm thick; oversized; gray

[www.wago.com/870-928](http://www.wago.com/870-928)



**Item no.: 870-929**  
Separator plate; 2 mm thick; oversized; orange

[www.wago.com/870-929](http://www.wago.com/870-929)

## Marking accessories

Marking strip



**Item no.: 709-196**  
Marking strips; for laser printer; translucent

[www.wago.com/709-196](http://www.wago.com/709-196)



**Item no.: 709-178**  
Marking strips; on reel; 7.5 mm wide; not stretchable; plain; snap-on type; white

[www.wago.com/709-178](http://www.wago.com/709-178)



**Item no.: 709-177**  
Marking strips; on reel; 7.5 mm wide; not stretchable; plain; snap-on type; translucent

[www.wago.com/709-177](http://www.wago.com/709-177)

Marker

Subject to changes. Please also observe the further product documentation!

	<b>Item no.: 2009-115/000-002</b> WMB-Inline; for Smart Printer; 1500 pieces on roll; stretchable 5 - 5.2 mm; plain; snap-on type; yellow	<a href="http://www.wago.com/2009-115/000-002">www.wago.com/2009-115/000-002</a>
	<b>Item no.: 2009-115/000-007</b> WMB-Inline; for Smart Printer; 1500 pieces on roll; stretchable 5 - 5.2 mm; plain; snap-on type; gray	<a href="http://www.wago.com/2009-115/000-007">www.wago.com/2009-115/000-007</a>
	<b>Item no.: 2009-115/000-017</b> WMB-Inline; for Smart Printer; 1500 pieces on roll; stretchable 5 - 5.2 mm; plain; snap-on type; light green	<a href="http://www.wago.com/2009-115/000-017">www.wago.com/2009-115/000-017</a>
	<b>Item no.: 2009-115/000-023</b> WMB-Inline; for Smart Printer; 1500 pieces on roll; stretchable 5 - 5.2 mm; plain; snap-on type; green	<a href="http://www.wago.com/2009-115/000-023">www.wago.com/2009-115/000-023</a>
	<b>Item no.: 2009-115/000-024</b> WMB-Inline; for Smart Printer; 1500 pieces on roll; stretchable 5 - 5.2 mm; plain; snap-on type; violet	<a href="http://www.wago.com/2009-115/000-024">www.wago.com/2009-115/000-024</a>
	<b>Item no.: 2009-145/000-006</b> Mini-WSB Inline; for Smart Printer; 1700 pieces on roll; stretchable 5 - 5.2 mm; plain; snap-on type; blue	<a href="http://www.wago.com/2009-145/000-006">www.wago.com/2009-145/000-006</a>
	<b>Item no.: 2009-145</b> Mini-WSB Inline; for Smart Printer; 1700 pieces on roll; stretchable 5 - 5.2 mm; plain; snap-on type; white	<a href="http://www.wago.com/2009-145">www.wago.com/2009-145</a>
	<b>Item no.: 2009-145/000-002</b> Mini-WSB Inline; for Smart Printer; 1700 pieces on roll; stretchable 5 - 5.2 mm; plain; snap-on type; yellow	<a href="http://www.wago.com/2009-145/000-002">www.wago.com/2009-145/000-002</a>
	<b>Item no.: 2009-145/000-007</b> Mini-WSB Inline; for Smart Printer; 1700 pieces on roll; stretchable 5 - 5.2 mm; plain; snap-on type; gray	<a href="http://www.wago.com/2009-145/000-007">www.wago.com/2009-145/000-007</a>
	<b>Item no.: 2009-145/000-005</b> Mini-WSB Inline; for Smart Printer; 1700 pieces on roll; stretchable 5 - 5.2 mm; plain; snap-on type; red	<a href="http://www.wago.com/2009-145/000-005">www.wago.com/2009-145/000-005</a>
	<b>Item no.: 2009-145/000-012</b> Mini-WSB Inline; for Smart Printer; 1700 pieces on roll; stretchable 5 - 5.2 mm; plain; snap-on type; orange	<a href="http://www.wago.com/2009-145/000-012">www.wago.com/2009-145/000-012</a>
	<b>Item no.: 2009-145/000-023</b> Mini-WSB Inline; for Smart Printer; 1700 pieces on roll; stretchable 5 - 5.2 mm; plain; snap-on type; green	<a href="http://www.wago.com/2009-145/000-023">www.wago.com/2009-145/000-023</a>
	<b>Item no.: 2009-145/000-024</b> Mini-WSB Inline; for Smart Printer; 1700 pieces on roll; stretchable 5 - 5.2 mm; plain; snap-on type; violet	<a href="http://www.wago.com/2009-145/000-024">www.wago.com/2009-145/000-024</a>

Subject to changes. Please also observe the further product documentation!



**Item no.: 2009-115**

WMB-Inline; for Smart Printer; 1500 pieces on roll; stretchable 5 - 5.2 mm; plain; snap-on type; white

[www.wago.com/2009-115](http://www.wago.com/2009-115)



**Item no.: 248-501/000-006**

Mini-WSB marking card; as card; not stretchable; plain; snap-on type; blue

[www.wago.com/248-501/000-006](http://www.wago.com/248-501/000-006)



**Item no.: 248-501/000-007**

Mini-WSB marking card; as card; not stretchable; plain; snap-on type; gray

[www.wago.com/248-501/000-007](http://www.wago.com/248-501/000-007)



**Item no.: 248-501/000-002**

Mini-WSB marking card; as card; not stretchable; plain; snap-on type; yellow

[www.wago.com/248-501/000-002](http://www.wago.com/248-501/000-002)



**Item no.: 248-501/000-012**

Mini-WSB marking card; as card; not stretchable; plain; snap-on type; orange

[www.wago.com/248-501/000-012](http://www.wago.com/248-501/000-012)



**Item no.: 248-501**

Mini-WSB marking card; as card; not stretchable; plain; snap-on type; white

[www.wago.com/248-501](http://www.wago.com/248-501)



**Item no.: 248-501/000-017**

Mini-WSB marking card; as card; not stretchable; plain; snap-on type; light green

[www.wago.com/248-501/000-017](http://www.wago.com/248-501/000-017)



**Item no.: 248-501/000-005**

Mini-WSB marking card; as card; not stretchable; plain; snap-on type; red

[www.wago.com/248-501/000-005](http://www.wago.com/248-501/000-005)



**Item no.: 248-501/000-024**

Mini-WSB marking card; as card; not stretchable; plain; snap-on type; violet

[www.wago.com/248-501/000-024](http://www.wago.com/248-501/000-024)



**Item no.: 248-501/000-023**

Mini-WSB marking card; as card; not stretchable; plain; snap-on type; green

[www.wago.com/248-501/000-023](http://www.wago.com/248-501/000-023)



**Item no.: 793-5501/000-007**

WMB marking card; as card; for terminal block width 5 - 17.5 mm; stretchable 5 - 5.2 mm; plain; snap-on type; gray

[www.wago.com/793-5501/000-007](http://www.wago.com/793-5501/000-007)



**Item no.: 793-5501/000-012**

WMB marking card; as card; for terminal block width 5 - 17.5 mm; stretchable 5 - 5.2 mm; plain; snap-on type; orange

[www.wago.com/793-5501/000-012](http://www.wago.com/793-5501/000-012)

Subject to changes. Please also observe the further product documentation!

WAGO GmbH & Co. KG

Hansastr. 27

32423 Minden

Phone: +49571 887-0 | Fax: +49571 887-169

Email: [info.de@wago.com](mailto:info.de@wago.com) | Web: [www.wago.com](http://www.wago.com)

Do you have any questions about our products?

We are always happy to take your call at +49 (571) 887-44222.



**Item no.:** 793-5501/000-017

WMB marking card; as card; for terminal block width 5 - 17.5 mm; stretchable 5 - 5.2 mm; plain; snap-on type; light green [www.wago.com/793-5501/000-017](http://www.wago.com/793-5501/000-017)



**Item no.:** 793-5501/000-023

WMB marking card; as card; for terminal block width 5 - 17.5 mm; stretchable 5 - 5.2 mm; plain; snap-on type; green [www.wago.com/793-5501/000-023](http://www.wago.com/793-5501/000-023)



**Item no.:** 793-5501/000-024

WMB marking card; as card; for terminal block width 5 - 17.5 mm; stretchable 5 - 5.2 mm; plain; snap-on type; violet [www.wago.com/793-5501/000-024](http://www.wago.com/793-5501/000-024)



**Item no.:** 793-501/000-002

WMB marking card; as card; not stretchable; plain; snap-on type; yellow [www.wago.com/793-501/000-002](http://www.wago.com/793-501/000-002)



**Item no.:** 793-501/000-007

WMB marking card; as card; not stretchable; plain; snap-on type; gray [www.wago.com/793-501/000-007](http://www.wago.com/793-501/000-007)



**Item no.:** 793-501/000-017

WMB marking card; as card; not stretchable; plain; snap-on type; light green [www.wago.com/793-501/000-017](http://www.wago.com/793-501/000-017)



**Item no.:** 793-501/000-012

WMB marking card; as card; not stretchable; plain; snap-on type; orange [www.wago.com/793-501/000-012](http://www.wago.com/793-501/000-012)



**Item no.:** 793-501/000-023

WMB marking card; as card; not stretchable; plain; snap-on type; green [www.wago.com/793-501/000-023](http://www.wago.com/793-501/000-023)

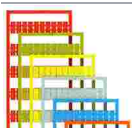

**Item no.:** 793-501/000-006

WMB marking card; as card; not stretchable; plain; snap-on type; blue [www.wago.com/793-501/000-006](http://www.wago.com/793-501/000-006)

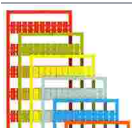

**Item no.:** 793-501/000-005

WMB marking card; as card; not stretchable; plain; snap-on type; red [www.wago.com/793-501/000-005](http://www.wago.com/793-501/000-005)



**Item no.:** 793-501

WMB marking card; as card; not stretchable; plain; snap-on type; white [www.wago.com/793-501](http://www.wago.com/793-501)

Subject to changes. Please also observe the further product documentation!

WAGO GmbH & Co. KG

Hansastr. 27

32423 Minden

Phone: +49571 887-0 | Fax: +49571 887-169

Email: [info.de@wago.com](mailto:info.de@wago.com) | Web: [www.wago.com](http://www.wago.com)

Do you have any questions about our products?

We are always happy to take your call at +49 (571) 887-44222.





**Item no.: 793-501/000-024**  
WMB marking card; as card; not stretchable; plain; snap-on type; violet

[www.wago.com/793-501/000-024](http://www.wago.com/793-501/000-024)



**Item no.: 793-5501/000-005**  
WMB marking card; as card; for terminal block width 5 - 17.5 mm; stretchable 5 - 5.2 mm; plain; snap-on type; red

[www.wago.com/793-5501/000-005](http://www.wago.com/793-5501/000-005)



**Item no.: 793-5501/000-002**  
WMB marking card; as card; for terminal block width 5 - 17.5 mm; stretchable 5 - 5.2 mm; plain; snap-on type; yellow

[www.wago.com/793-5501/000-002](http://www.wago.com/793-5501/000-002)



**Item no.: 793-5501/000-006**  
WMB marking card; as card; for terminal block width 5 - 17.5 mm; stretchable 5 - 5.2 mm; plain; snap-on type; blue

[www.wago.com/793-5501/000-006](http://www.wago.com/793-5501/000-006)



**Item no.: 793-5501**  
WMB marking card; as card; for terminal block width 5 - 17.5 mm; stretchable 5 - 5.2 mm; plain; snap-on type; white

[www.wago.com/793-5501](http://www.wago.com/793-5501)



**Item no.: 2009-115/000-012**  
WMB-Inline; for Smart Printer; 1500 pieces on roll; stretchable 5 - 5.2 mm; plain; snap-on type; orange

[www.wago.com/2009-115/000-012](http://www.wago.com/2009-115/000-012)



**Item no.: 2009-115/000-006**  
WMB-Inline; for Smart Printer; 1500 pieces on roll; stretchable 5 - 5.2 mm; plain; snap-on type; blue

[www.wago.com/2009-115/000-006](http://www.wago.com/2009-115/000-006)

#### Group marker carrier



**Item no.: 870-183**  
Adaptor; gray

[www.wago.com/870-183](http://www.wago.com/870-183)



**Item no.: 870-182**  
Adaptor; gray

[www.wago.com/870-182](http://www.wago.com/870-182)



**Item no.: 870-184**  
Adaptor; gray

[www.wago.com/870-184](http://www.wago.com/870-184)

#### Mounting

##### Mounting accessories



**Item no.: 209-106**  
Mounting carrier; for isolated mounting on DIN 35 rails; gray

[www.wago.com/209-106](http://www.wago.com/209-106)



**Item no.: 249-101**  
Screwless end stop; 6 mm wide; for WMB markers; gray

[www.wago.com/249-101](http://www.wago.com/249-101)

#### Jumpers

##### Jumper



**Item no.: 870-402**

Subject to changes. Please also observe the further product documentation!

Jumper; 2-way; insulated; light gray

[www.wago.com/870-402](http://www.wago.com/870-402)



Item no.: 870-404

[www.wago.com/870-404](http://www.wago.com/870-404)



Item no.: 870-405

Jumper; 5-way; insulated; light gray

[www.wago.com/870-405](http://www.wago.com/870-405)



Item no.: 870-407

Jumper; 7-way; insulated; light gray

[www.wago.com/870-407](http://www.wago.com/870-407)



Item no.: 870-408

Jumper; 8-way; insulated; light gray

[www.wago.com/870-408](http://www.wago.com/870-408)



Item no.: 870-403

Jumper; 3-way; insulated; light gray

[www.wago.com/870-403](http://www.wago.com/870-403)



Item no.: 870-409

Jumper; 9-way; insulated; light gray

[www.wago.com/870-409](http://www.wago.com/870-409)



Item no.: 870-406

Jumper; 6-way; insulated; light gray

[www.wago.com/870-406](http://www.wago.com/870-406)

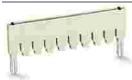

Item no.: 870-433

Jumper; from 1 to 3; insulated; light gray

[www.wago.com/870-433](http://www.wago.com/870-433)



Item no.: 870-435

Jumper; from 1 to 5; insulated; light gray

[www.wago.com/870-435](http://www.wago.com/870-435)



Item no.: 870-410

Jumper; 10-way; insulated; light gray

[www.wago.com/870-410](http://www.wago.com/870-410)



Item no.: 870-434

Jumper; from 1 to 4; insulated; light gray

[www.wago.com/870-434](http://www.wago.com/870-434)



Item no.: 870-436

Jumper; from 1 to 6; insulated; light gray

[www.wago.com/870-436](http://www.wago.com/870-436)



Item no.: 870-440

Jumper; from 1 to 10; insulated; light gray

[www.wago.com/870-440](http://www.wago.com/870-440)

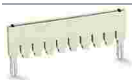

Item no.: 870-437

Jumper; from 1 to 7; insulated; light gray

[www.wago.com/870-437](http://www.wago.com/870-437)

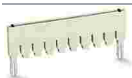

Item no.: 870-439

Jumper; from 1 to 9; insulated; light gray

[www.wago.com/870-439](http://www.wago.com/870-439)

Subject to changes. Please also observe the further product documentation!

WAGO GmbH & Co. KG

Hansastr. 27

32423 Minden

Phone: +49571 887-0 | Fax: +49571 887-169

Email: [info.de@wago.com](mailto:info.de@wago.com) | Web: [www.wago.com](http://www.wago.com)

Do you have any questions about our products?

We are always happy to take your call at +49 (571) 887-44222.



**Item no.: 870-438**  
Jumper; from 1 to 8; insulated; light gray

[www.wago.com/870-438](http://www.wago.com/870-438)



**Item no.: 870-406/020-000**  
Delta jumper; insulated; light gray

[www.wago.com/870-406/020-000](http://www.wago.com/870-406/020-000)

## Testing and measuring

### Testing accessories



**Item no.: 870-425**  
Tap-off module; with anti-rotation protection; modular; suitable for 870 Series terminal blocks with jumper slots in the current bar; gray [www.wago.com/870-425](http://www.wago.com/870-425)



**Item no.: 870-426**  
Tap-off module; modular; suitable for 870 Series terminal blocks with jumper slots in the current bar; gray [www.wago.com/870-426](http://www.wago.com/870-426)



**Item no.: 870-427**  
Spacer module; modular; bridging commoned terminal blocks; gray [www.wago.com/870-427](http://www.wago.com/870-427)

## Carrier rail

### Mounting accessories



**Item no.: 210-295**  
Steel carrier rail; 15 x 5.5 mm; 1 mm thick; 2 m long; unslotted; according to EN 60715; silver-colored [www.wago.com/210-295](http://www.wago.com/210-295)



**Item no.: 210-296**  
Aluminum carrier rail; 15 x 5.5 mm; 1 mm thick; 2 m long; unslotted; similar to EN 60715; silver-colored [www.wago.com/210-296](http://www.wago.com/210-296)



**Item no.: 210-111**  
Steel carrier rail; 15 x 5.5 mm; 1 mm thick; 2 m long; slotted; according to EN 60715; silver-colored [www.wago.com/210-111](http://www.wago.com/210-111)

## Insulation stop

### Insulation stop



**Item no.: 280-472**  
Insulation stop; 0.75 - 1 mm<sup>2</sup>; 5 pieces/strip; black [www.wago.com/280-472](http://www.wago.com/280-472)



**Item no.: 280-470**  
Insulation stop; 0.08 - 0.2 mm<sup>2</sup> "s" (0.14 mm<sup>2</sup> "f-st"); 5 pieces/strip; white [www.wago.com/280-470](http://www.wago.com/280-470)



**Item no.: 280-471**  
Insulation stop; 0.25 - 0.5 mm<sup>2</sup>; 5 pieces/strip; light gray [www.wago.com/280-471](http://www.wago.com/280-471)

## Protective warning marker

### Cover















**Item no.: 280-405**  
Protective warning marker; for 5 terminal blocks; with high-voltage symbol, black; yellow [www.wago.com/280-405](http://www.wago.com/280-405)



## Ferrule

### Ferrule

Subject to changes. Please also observe the further product documentation!

	<b>Item no.: 216-123</b> Ferrule; Sleeve for 1 mm <sup>2</sup> / AWG 18; uninsulated; electro-tin plated; silver-colored	<a href="http://www.wago.com/216-123">www.wago.com/216-123</a>
	<b>Item no.: 216-122</b> Ferrule; Sleeve for 0.75 mm <sup>2</sup> / AWG 20; uninsulated; electro-tin plated; silver-colored	<a href="http://www.wago.com/216-122">www.wago.com/216-122</a>
	<b>Item no.: 216-124</b> Ferrule; Sleeve for 1.5 mm <sup>2</sup> / AWG 16; uninsulated; electro-tin plated	<a href="http://www.wago.com/216-124">www.wago.com/216-124</a>
	<b>Item no.: 216-132</b> Ferrule; Sleeve for 0.34 mm <sup>2</sup> / AWG 24; uninsulated; electro-tin plated	<a href="http://www.wago.com/216-132">www.wago.com/216-132</a>
	<b>Item no.: 216-121</b> Ferrule; Sleeve for 0.5 mm <sup>2</sup> / AWG 22; uninsulated; electro-tin plated; silver-colored	<a href="http://www.wago.com/216-121">www.wago.com/216-121</a>
	<b>Item no.: 216-131</b> Ferrule; Sleeve for 0.25 mm <sup>2</sup> / AWG 24; uninsulated; electro-tin plated; silver-colored	<a href="http://www.wago.com/216-131">www.wago.com/216-131</a>
	<b>Item no.: 216-223</b> Ferrule; Sleeve for 1 mm <sup>2</sup> / AWG 18; insulated; electro-tin plated; red	<a href="http://www.wago.com/216-223">www.wago.com/216-223</a>
	<b>Item no.: 216-222</b> Ferrule; Sleeve for 0.75 mm <sup>2</sup> / 18 AWG; insulated; electro-tin plated; gray	<a href="http://www.wago.com/216-222">www.wago.com/216-222</a>
	<b>Item no.: 216-221</b> Ferrule; Sleeve for 0.5 mm <sup>2</sup> / 20 AWG; insulated; electro-tin plated; white	<a href="http://www.wago.com/216-221">www.wago.com/216-221</a>
	<b>Item no.: 216-224</b> Ferrule; Sleeve for 1.5 mm <sup>2</sup> / AWG 16; insulated; electro-tin plated; black	<a href="http://www.wago.com/216-224">www.wago.com/216-224</a>
	<b>Item no.: 216-321</b> Ferrule; Sleeve for 0.25 mm <sup>2</sup> / AWG 24; insulated; electro-tin plated; yellow	<a href="http://www.wago.com/216-321">www.wago.com/216-321</a>
	<b>Item no.: 216-322</b> Ferrule; Sleeve for 0.34 mm <sup>2</sup> / 22 AWG; insulated; electro-tin plated; light turquoise	<a href="http://www.wago.com/216-322">www.wago.com/216-322</a>

**Tool**

Operating tool		
	<b>Item no.: 210-657</b> Operating tool; Blade: 3.5 x 0.5 mm; with a partially insulated shaft; short; multicoloured	<a href="http://www.wago.com/210-657">www.wago.com/210-657</a>
	<b>Item no.: 210-658</b> Operating tool; Blade: 3.5 x 0.5 mm; with a partially insulated shaft; angled; short; multicoloured	<a href="http://www.wago.com/210-658">www.wago.com/210-658</a>
	<b>Item no.: 210-720</b> Operating tool; Blade: 3.5 x 0.5 mm; with a partially insulated shaft; multicoloured	<a href="http://www.wago.com/210-720">www.wago.com/210-720</a>

Subject to changes. Please also observe the further product documentation!



## Downloads

### Documentation

#### Bid Text

870-911 X81 - Datei	2019 Feb 19	xml 3.3 kB	Download
------------------------	-------------	---------------	----------

870-911 doc - Datei	2017 May 31	doc 25.1 kB	Download
------------------------	-------------	----------------	----------

#### Additional Information

Technical Section Technical explanations		pdf 2.2 MB	Download
---	--	---------------	----------

## CAD/CAE-Data

### CAE data

EPLAN Data Portal 870-911		URL	Download
---------------------------	--	-----	----------

WSCAD Universe 870-911		URL	Download
------------------------	--	-----	----------

ZUKEN Portal 870-911		URL	Download
----------------------	--	-----	----------

### CAD data

2D/3D Models 870-911		URL	Download
----------------------	--	-----	----------

## Environmental Product Compliance

### Compliance Search

Environmental Product Compliance 870-911 2-conductor through terminal block; 2.5 mm <sup>2</sup> ; side and center marking; for DIN-15 rail; CAGE CLAMP®; 2,50 mm <sup>2</sup> ; gray		URL	Download
--	--	-----	----------

## Installation Notes

### Installation

Subject to changes. Please also observe the further product documentation!

WAGO GmbH & Co. KG  
Hansastr. 27  
32423 Minden  
Phone: +49571 887-0 | Fax: +49571 887-169  
Email: [info.de@wago.com](mailto:info.de@wago.com) | Web: [www.wago.com](http://www.wago.com)

Do you have any questions about our products?  
We are always happy to take your call at +49 (571) 887-44222.



#### Mounting on DIN-15 rail:

Snap individual terminal blocks onto the DIN-15 rail and slide together.

#### Removal from DIN-15 rail:

Open assembly by laterally sliding terminal blocks with an operating tool and remove them from the rail.

#### Conductor termination

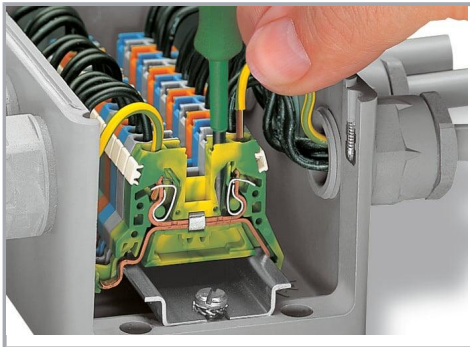

#### CAGE CLAMP® connection

Inserting a conductor via operating tool (0.08 ... 4 mm<sup>2</sup> "f-st").

With ferruled conductors, it is necessary to use a terminal block one size smaller than the conductor's nominal cross-section.

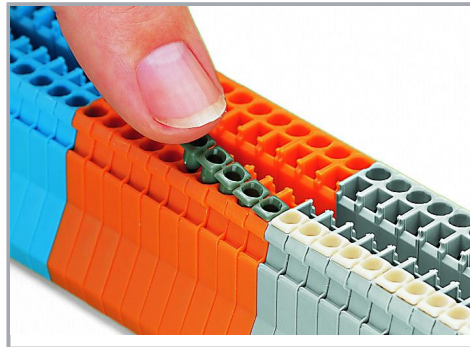

Inserting insulation stops into conductor entry holes of terminal strip.

#### Commoning

Subject to changes. Please also observe the further product documentation!

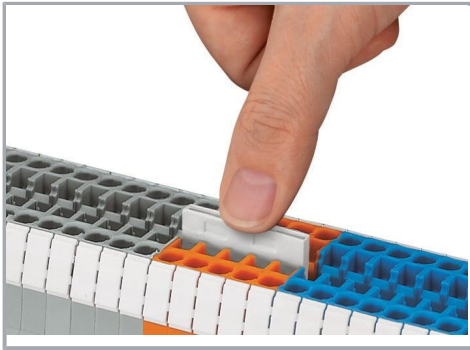

Push jumper bars down firmly until fully inserted. When using multipole bars, push alternately on the right and then left side until installed.

Commoning with push-in type jumper bars:

Two parallel jumper slots are accommodated in one terminal block.

Push-in type jumper bars 1 – 3 – 5 – 7 or  
1 – – 4 – – 7

upon request

#### Testing

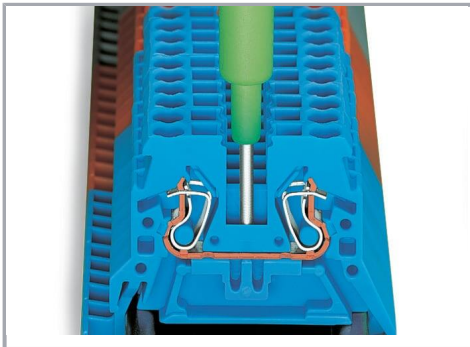

Testing with phase testing device, also possible with single-pole voltage tester.

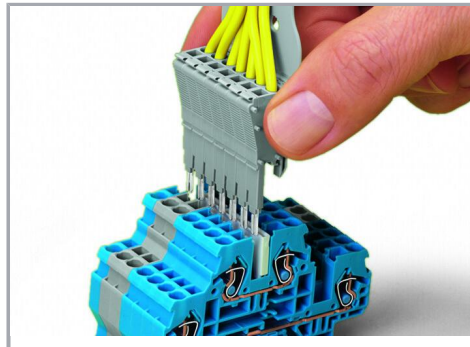

Testing is also possible using a pre-wired tap-off module assembly in the very same way as test plugs.

#### Cover

Subject to changes. Please also observe the further product documentation!



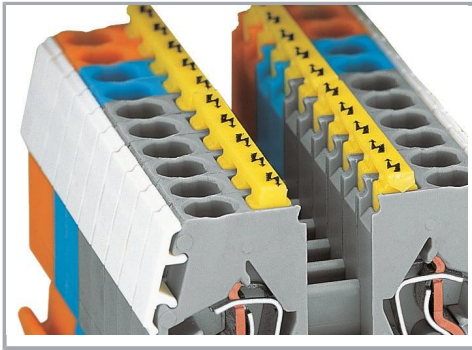

Protective warning markers (280-405), with a black high-voltage symbol

### Marking

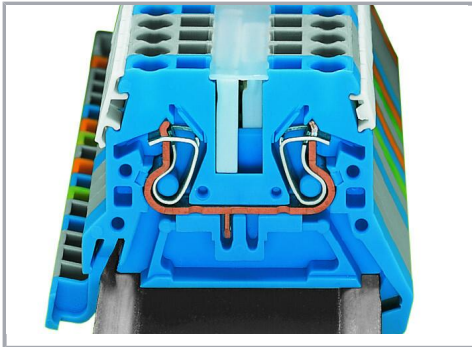

WMB markers in Mini-WSB marker slots

Translucent marking strip

Mini-WSB markers

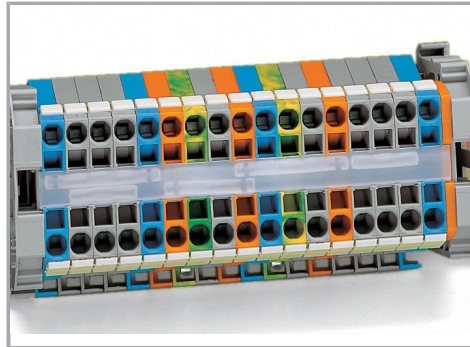

Translucent marking strip (709-196) – jumpers below may be visible.

Subject to changes. Please also observe the further product documentation!



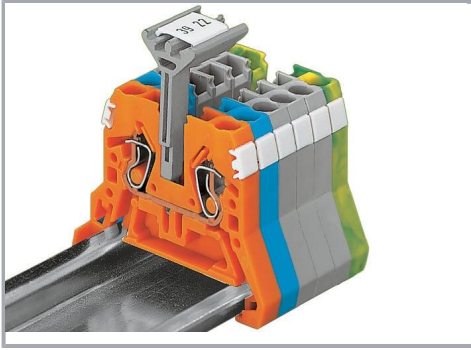

In addition to the plastic marker strips, group marker carriers are now available for the WMB and WSB marking systems. They can be mounted in parallel to a push-in type jumper bar via the open jumper contact slot. It is also very useful if the marker slots on the side of the terminal block are hidden. The carriers are available in the following widths: 5 mm (0.197 inch), 10 mm (0.394 inch) and 15 mm (0.591 inch).

**Notice:**

Group marker carriers are not suitable for ground conductor terminal blocks and double potential terminal blocks as they have no jumper contact slots.

Subject to changes. Please also observe the further product documentation!