

QSFP-100G-FR-C

Juniper Networks® QSFP-100G-FR Compatible TAA 100GBase-FR QSFP28 Transceiver (SMF, 1310nm, 2km, LC)

Features:

- SFF-8665 Compliance
- Duplex LC Connector
- Single-mode Fiber
- Commercial Temperature 0 to 70 Celsius
- Hot Pluggable
- Metal with Lower EMI
- Excellent ESD Protection
- RoHS Compliant and Lead Free



Applications:

- 100GBase Ethernet
- Access and Enterprise

Product Description

This Juniper Networks® QSFP-100G-FR compatible QSFP28 transceiver provides 100GBase-FR throughput up to 2km over single-mode fiber (SMF) using a wavelength of 1310nm via an LC connector. It is guaranteed to be 100% compatible with the equivalent Juniper Networks® transceiver. This easy to install, hot swappable transceiver has been programmed, uniquely serialized and data-traffic and application tested to ensure that it will initialize and perform identically. Digital optical monitoring (DOM) support is also present to allow access to real-time operating parameters. This transceiver is Trade Agreements Act (TAA) compliant. We stand behind the quality of our products and proudly offer a limited lifetime warranty.

ProLabs's transceivers are RoHS compliant and lead-free.

TAA refers to the Trade Agreements Act (19 U.S.C. & 2501-2581), which is intended to foster fair and open international trade. TAA requires that the U.S. Government may acquire only "U.S. – made or designated country end products."



Regulatory Compliance

- ESD to the Electrical PINs: compatible with MIL-STD-883E Method 3015.4
- ESD to the LC Receptacle: compatible with IEC 61000-4-3
- EMI/EMC compatible with FCC Part 15 Subpart B Rules, EN55022:2010
- Laser Eye Safety compatible with FDA 21CFR, EN60950-1& EN (IEC) 60825-1,2
- RoHS compliant with EU RoHS 2.0 directive 2015/863/EU

Absolute Maximum Ratings

Parameter	Symbol	Min.	Typ.	Max.	Unit
Maximum Supply Voltage	Vcc	-0.5		3.6	V
Storage Temperature	TS	-40		85	°C
Operating Case Temperature	Top	0		70	°C
Relative Humidity (non-condensation)	RH	0		85	%
Damage Threshold	THd	5.5			dBm

Recommended Operating Conditions and Power Supply Requirements

Parameter	Symbol	Min.	Typ.	Max.	Unit	Notes
Operating Case Temperature	Top	0		70	°C	
Power Supply Voltage	Vcc	3.135	3.3	3.465	V	
Electrical Data Rate, each Lane (NRZ)			25.78125		Gb/s	
Optical Data Rate (PAM4)			53.125		GBd	
Data Rate Accuracy		-100		100	ppm	
Pre-FEC Bit Error Ratio				2.4×10^{-4}		
Post-FEC Bit Error Ratio				1×10^{-12}		1
Control Input Voltage High		2		Vcc	V	
Control Input Voltage Low		0		0.8	V	
Link Distance with G.652	D	0.002		2	km	2

Notes:

1. FEC feature is embedded in the module.
2. FEC required to be turned on to support maximum transmission distance.

Electrical Characteristics

The following electrical characteristics are defined over the Recommended Operating Environment unless otherwise specified.

Parameter	Test Point	Min.	Typ.	Max.	Unit	Notes
Power Consumption				4.5	W	
Supply Current	I _{cc}			1.36	A	
Transmitter (each Lane)						
Overload Differential Voltage pk-pk	TP1a	900			mV	
Common Mode Voltage (V _{cm})	TP1	-350		2850	mV	1
Differential Termination Resistance Mismatch	TP1			10	%	At 1MHz
Differential Return Loss (SDD11)	TP1			See CEI28G-VSR Equation 13-19	dB	
Common Mode to Differential Conversion and Differential to Common Mode Conversion (SDC11, SCD11)	TP1			See CEI28G-VSR Equation 13-20	dB	
Stressed Input Test	TP1a	See CEI28G-VSR Section 13.3.11.2.1				
Receiver (each Lane)						
Differential Voltage, pk-pk	TP4			900	mV	
Common Mode Voltage (V _{cm})	TP4	-350		2850	mV	1
Common Mode Noise, RMS	TP4			17.5	mV	
Differential Termination Resistance Mismatch	TP4			10	%	At 1MHz
Differential Return Loss (SDD22)	TP4			See CEI28G-VSR Equation 13-19	dB	
Common Mode to Differential Conversion and Differential to Common Mode Conversion (SDC22, SCD22)	TP4			See CEI28G-VSR Equation 13-21	dB	
Common Mode Return Loss (SCC22)	TP4			-2	dB	2
Transition Time, 20 to 80%	TP4	9.5			ps	
Vertical Eye Closure (VEC)	TP4			5.5	dB	
Eye Width at 10 ⁻¹⁵ probability (EW15)	TP4	0.57			UI	
Eye Height at 10 ⁻¹⁵ probability (EH15)	TP4	228			mV	

Notes:

1. V_{cm} is generated by the host. Specification includes effects of ground offset voltage.
2. From 250MHz to 30GHz.

Optical Characteristics

Parameter	Symbol	Min.	Typ.	Max.	Unit	Notes
Transmitter						
Center Wavelength	λ_t	1304.5		1317.5	nm	
Side Mode Suppression Ratio	SMSR	30			dB	
Average Launch Power	PAVG	-2.4		4	dBm	1
Outer Optical Modulation Amplitude (OMA _{outer})	POMA	-0.2		4.2	dBm	2
Launch power in OMA _{outer} minus TDECQ, for ER \geq 4.5dB	OMA _{outer} -TDECQ	-1.6			dBm	
Launch power in OMA _{outer} minus TDECQ, for ER < 4.5dB	OMA _{outer} -TDECQ	-1.5			dBm	
Transmitter and Dispersion Eye Closure for PAM4 (TDECQ)	TDECQ			3.4	dB	
TDECQ – 10*log ₁₀ (C _{eq})				3.4	dB	3
Extinction Ratio	ER	3.5			dB	
RIN _{17.1OMA}	RIN			-136	dB/Hz	
Optical Return Loss Tolerance	TOL			17.1	dB	
Transmitter Reflectance	RT			-26	dB	
Transmitter Transition Time				17	ps	
Average Launch Power of OFF Transmitter	Poff			-15	dBm	
Receiver						
Center Wavelength	λ_r	1304.5		1317.5	nm	
Damage Threshold	TH _d	5.5			dBm	4
Average Receive Power		-6.4		4.5	dBm	5
Receive Power (OMA _{outer})				4.7	dBm	
Receiver Sensitivity (OMA _{outer})	SEN			Equation (1)	dBm	6
Stressed Receiver Sensitivity (OMA _{outer})	SRS			-2.5	dBm	7
Receiver Reflectance	RR			-26	dB	
LOS Assert	LOSA	-15			dBm	
LOS Deassert	LOSD			-9.4	dBm	
LOS Hysteresis	LOSH	0.5			dB	
Conditions of stressed receiver sensitivity test:						
Stressed Eye Closure for PAM4 (SECQ)			3.4		dB	8
SECQ – 10*log ₁₀ (C _{eq})				3.4	dB	8

Notes:

1. Average launch power, each lane min is informative and not the principal indicator of signal strength. A transmitter with launch power below this value cannot be compliant; however, a value above this does not ensure compliance.

2. Even if the TDECQ < 1.4dB for an extinction ratio of ≥ 4.5 dB or TDECQ < 1.3dB for an extinction ratio of < 4.5dB, the OMAouter (min) must exceed the minimum value specified here.
3. Ceq is a coefficient defined in IEEE Std 802.3-2018 clause 121.8.5.3 which accounts for reference equalizer noise enhancement.
4. Average receive power (min) is informative and not the principal indicator of signal strength. A received power below this value cannot be compliant; however, a value above this does not ensure compliance.
5. The receiver shall be able to tolerate, without damage, continuous exposure to a modulated optical input signal having this power level on one lane. The receiver does not have to operate correctly at this input power.
6. Receiver sensitivity (OMAouter) (max) is informative and is defined for a transmitter with a value of SECQ up to 3.4 dB. It should meet Equation (1), which is illustrated in the figure below.

$$RS = \max(-4.5, SECQ - 5.9) \text{ dBm} \quad (1)$$

Where:

RS is the receiver sensitivity, and

SECQ is the SECQ of the transmitter used to measure the receiver sensitivity.

7. Measured with conformance test signal at TP3 for the BER equal to 2.4×10^{-4} .
8. These test conditions are for measuring stressed receiver sensitivity. They are not characteristics of the receiver.

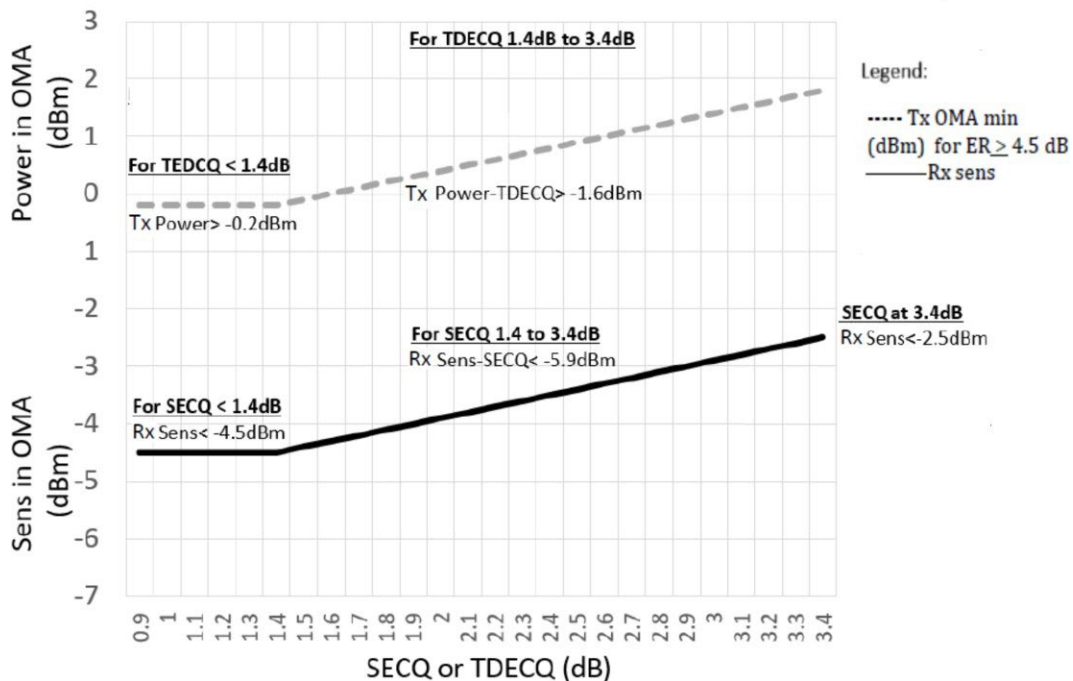

Illustration of Receiver Sensitivity Mask for 100G-FR

Pin Descriptions

Pin	Logic	Symbol	Name/Descriptions	Ref.
1		GND	Module Ground	1
2	CML-I	Tx2-	Transmitter inverted data input	
3	CML-I	Tx2+	Transmitter non-inverted data input	
4		GND	Module Ground	1
5	CML-I	Tx4-	Transmitter inverted data input	
6	CML-I	Tx4+	Transmitter non-inverted data input	
7		GND	Module Ground	1
8	LVTTTL-I	MODSEIL	Module Select	
9	LVTTTL-I	ResetL	Module Reset	
10		VCCRx	+3.3v Receiver Power Supply	2
11	LVCNOS-I	SCL	2-wire Serial interface clock	
12	LVCNOS-I/O	SDA	2-wire Serial interface data	
13		GND	Module Ground	1
14	CML-O	RX3+	Receiver non-inverted data output	
15	CML-O	RX3-	Receiver inverted data output	
16		GND	Module Ground	1
17	CML-O	RX1+	Receiver non-inverted data output	
18	CML-O	RX1-	Receiver inverted data output	
19		GND	Module Ground	1
20		GND	Module Ground	1
21	CML-O	RX2-	Receiver inverted data output	
22	CML-O	RX2+	Receiver non-inverted data output	
23		GND	Module Ground	1
24	CML-O	RX4-	Receiver inverted data output	
25	CML-O	RX4+	Receiver non-inverted data output	
26		GND	Module Ground	1
27	LVTTTL-O	ModPrsL	Module Present, internal pulled down to GND	
28	LVTTTL-O	IntL	Interrupt output, should be pulled up on host board	
29		VCCTx	+3.3v Transmitter Power Supply	2
30		VCC1	+3.3v Power Supply	2
31	LVTTTL-I	LPMODE	Low Power Mode	
32		GND	Module Ground	1
33	CML-I	Tx3+	Transmitter non-inverted data input	
34	CML-I	Tx3-	Transmitter inverted data input	
35		GND	Module Ground	1
36	CML-I	Tx1+	Transmitter non-inverted data input	
37	CML-I	Tx1-	Transmitter inverted data input	
38		GND	Module Ground	1

Notes:

1. GND is the symbol for signal and supply (power) common for the QSFP28 module. All are common within the QSFP28 module and all module voltages are referenced to this potential unless otherwise noted. Connect these directly to the host board signal-common ground plane. Open collector; should be pulled up with 4.7k-10k ohms on host board to a voltage between 3.15V and 3.6V.
2. Vcc Rx, Vcc1 and Vcc Tx are the receiver and transmitter power supplies and shall be applied concurrently. Vcc Rx Vcc1 and Vcc Tx may be internally connected within the QSFP28 Module in any combination. The connector pins are each rated for a maximum current of 1000mA.

Electrical Pin-out Details

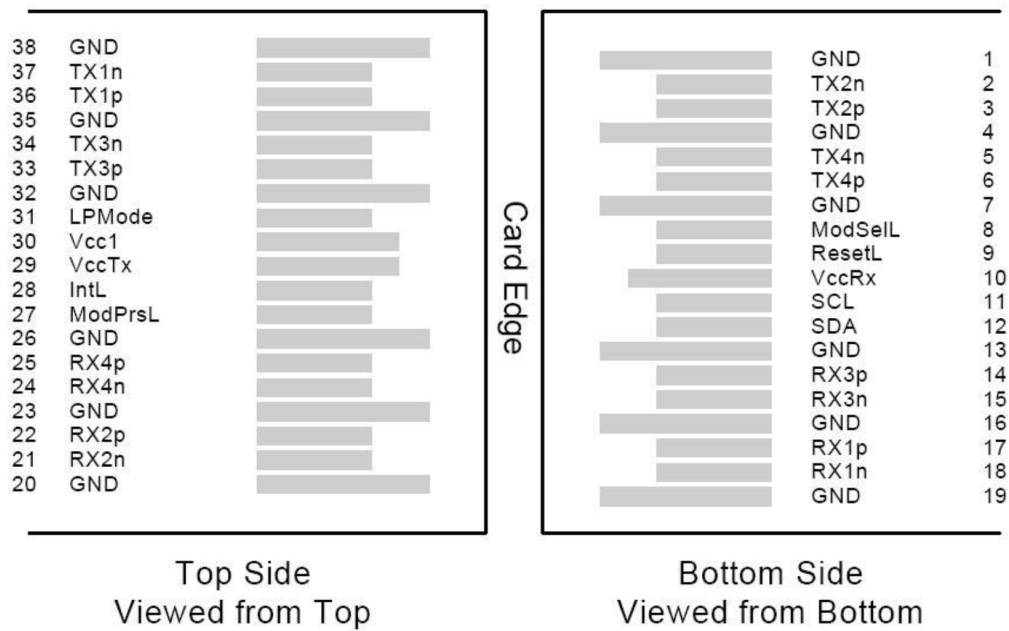

Recommended Power Supply Filter

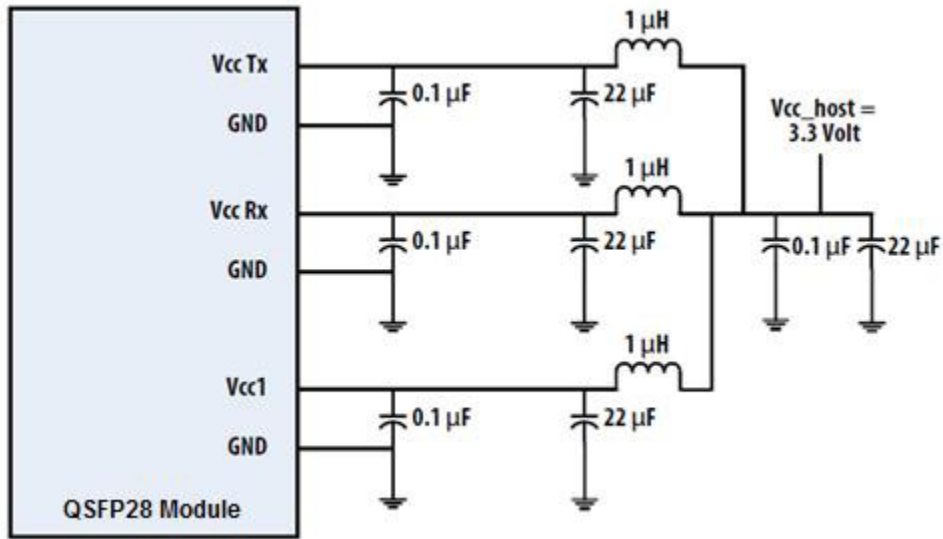

Digital Diagnostic Functions

The following digital diagnostic characteristics are defined over the normal operating conditions unless otherwise specified.

Parameter	Symbol	Min	Max	Units	Notes
Temperature Monitor Absolute Error	DMI_Temp	-3	3	degC	Over operating temperature range
Supply Voltage Monitor Absolute Error	DMI_VCC	-0.1	0.1	V	Over full operating range
RX Power Monitor Absolute Error	DMI_RX	-2	2	dB	1
Bias Current Monitor	DMI_Ibias	-10%	10%	mA	
TX Power Monitor Absolute Error	DMI_TX	-2	2	dB	1

Notes:

1. Due to measurement accuracy of different single mode fibers, there could be an additional +/-1 dB fluctuation, or a +/- 3 dB total accuracy.

Mechanical Specifications

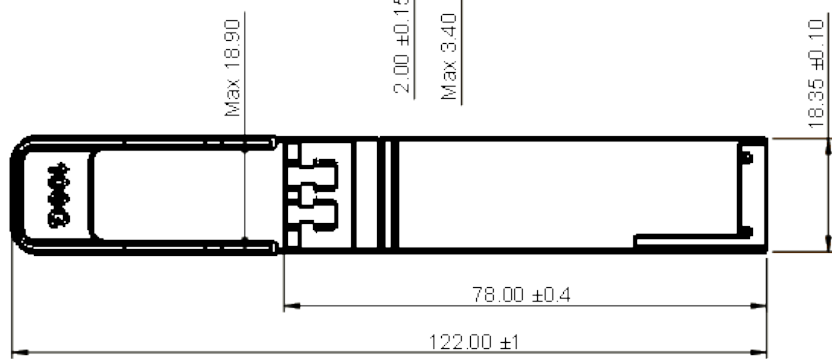
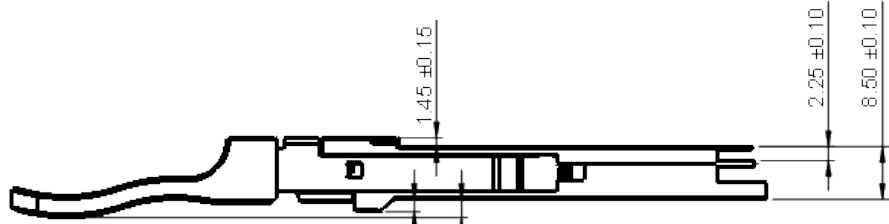
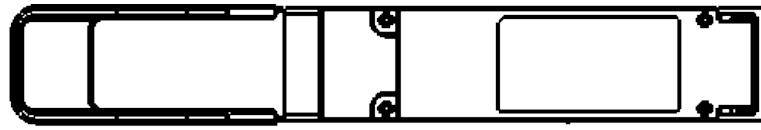
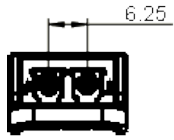

About ProLabs

Our experience comes as standard; for over 15 years ProLabs has delivered optical connectivity solutions that give our customers freedom and choice through our ability to provide seamless interoperability. At the heart of our company is the ability to provide state-of-the-art optical transport and connectivity solutions that are compatible with over 90 optical switching and transport platforms.

Complete Portfolio of Network Solutions

ProLabs is focused on innovations in optical transport and connectivity. The combination of our knowledge of optics and networking equipment enables ProLabs to be your single source for optical transport and connectivity solutions from 100Mb to 400G while providing innovative solutions that increase network efficiency. We provide the optical connectivity expertise that is compatible with and enhances your switching and transport equipment.

Trusted Partner

Customer service is our number one value. ProLabs has invested in people, labs and manufacturing capacity to ensure that you get immediate answers to your questions and compatible product when needed. With Engineering and Manufacturing offices in the U.K. and U.S. augmented by field offices throughout the U.S., U.K. and Asia, ProLabs is able to be our customers best advocate 24 hours a day.

Contact Information

ProLabs US

Email: sales@prolabs.com

Telephone: 952-852-0252

ProLabs UK

Email: salessupport@prolabs.com

Telephone: +44 1285 719 600