

**Data sheet | Item number: 2106-5204**

2-conductor through terminal block; with lever and push-button; 6 mm<sup>2</sup>; with test port; suitable for Ex i applications; side and center marking; for DIN-rail 35 x 15 and 35 x 7.5; Push-in CAGE CLAMP®; 6,00 mm<sup>2</sup>; blue

[www.wago.com/2106-5204](http://www.wago.com/2106-5204)

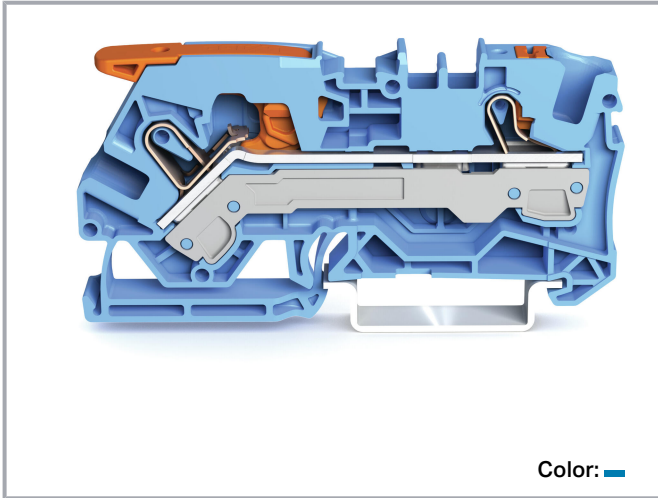

Color: 

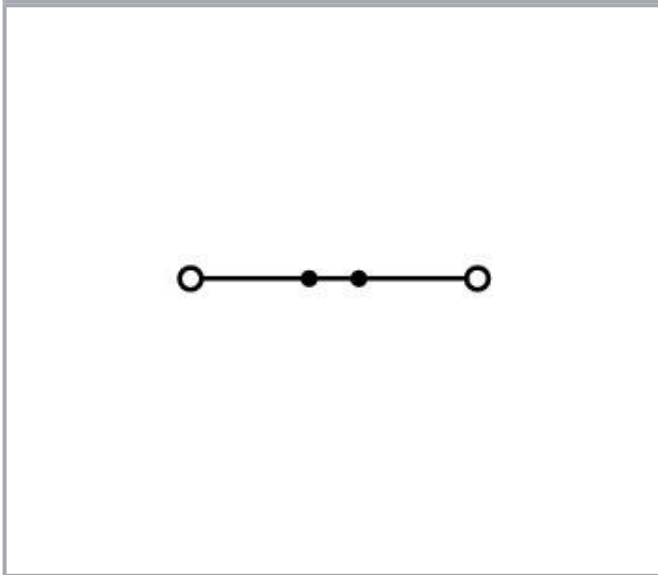
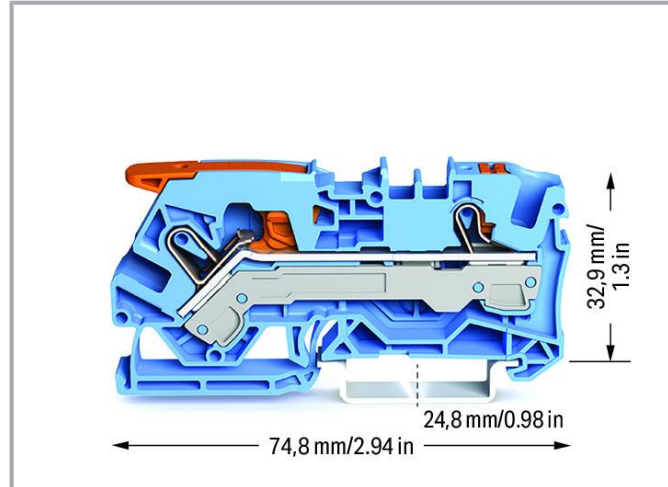

**Data**

**Electrical data**

**Ratings per IEC/EN**

Ratings per	IEC/EN 60947-7-1
Nominal voltage (III/3)	800 V

Subject to changes. Please also observe the further product documentation!

WAGO GmbH & Co. KG  
Hansastr. 27  
32423 Minden  
Phone: +49571 887-0 | Fax: +49571 887-169  
Email: [info.de@wago.com](mailto:info.de@wago.com) | Web: [www.wago.com](http://www.wago.com)

Do you have any questions about our products?  
We are always happy to take your call at +49 (571) 887-44222.



Rated impulse voltage (III/3)	8 kV
Rated current	41 A
Current at conductor cross-section (max.) mm <sup>2</sup>	55 A
Legend (ratings)	(III / 3) ≙ Overvoltage category III / Pollution degree 3

### Ratings per UL 1059

Approvals per	UL 1059
Rated voltage UL (Use Group B)	600 V
Rated current UL (Use Group B)	50 A
Rated voltage UL (Use Group C)	600 V
Rated current UL (Use Group C)	50 A
Rated voltage UL (Use Group D)	600 V
Rated current UL (Use Group D)	5 A
Rated voltage UL (Use Group B)	600 V
Rated current UL (Use Group B)	30 A
Rated voltage UL (Use Group C)	600 V
Rated current UL (Use Group C)	30 A

### Ratings per CSA

Approvals per	CSA 22.2 No 158
Rated voltage CSA (Use Group B)	600 V
Rated current CSA (Use Group B)	45 A
Rated voltage CSA (Use Group C)	600 V
Rated current CSA (Use Group C)	45 A

### Ex information

Reference hazardous areas	See "Downloads – Documentation – Additional Information: Technical Section; Technical Explications"
Ratings per	ATEX: PTB 18 ATEX 1011 U / IECEx: PTB 18.0018U (Ex eb IIC Gb)
Rated voltage EN (Ex e II)	550 V
Rated current (Ex e II)	41 A
Rated current (Ex e II) with jumper	33 A

### Power loss

Power loss, per pole (potential)	1.311 W
Rated current $I_N$ for specified power loss	41 A

Subject to changes. Please also observe the further product documentation!



Resistance value for specified, current-dependent power loss	0.001 $\Omega$
--	----------------

### Connection data

Connection points	2
Total number of potentials	1
Number of levels	1
Number of jumper slots	2

### Connection 1

Connection technology	Push-in CAGE CLAMP®
Actuation type	Lever
Connectable conductor materials	Copper
Nominal cross-section	6 mm <sup>2</sup>
Solid conductor	0.5 ... 10 mm <sup>2</sup> / 20 ... 8 AWG
Solid conductor; push-in termination	1 ... 10 mm <sup>2</sup> / 14 ... 8 AWG
Fine-stranded conductor	0.5 ... 10 mm <sup>2</sup> / 20 ... 8 AWG
Fine-stranded conductor; with insulated ferrule	0.5 ... 6 mm <sup>2</sup> / 20 ... 10 AWG
Fine-stranded conductor; with ferrule; push-in termination	2.5 ... 6 mm <sup>2</sup> / 16 ... 10 AWG
Note (conductor cross-section)	Depending on the conductor characteristic, a conductor with a smaller cross-section can also be inserted via push-in termination.
Strip length	13 ... 15 mm / 0.51 ... 0.59 inches
Wiring direction	Front-entry wiring

### Connection 2

Actuation type 2	Push-button
------------------	-------------

### Physical data

Width	7.5 mm / 0.295 inches
Height	74.8 mm / 2.945 inches
Depth from upper-edge of DIN-rail	32.9 mm / 1.295 inches

### Mechanical Data

Mounting type	DIN-35 rail
Marking level	Center/side marking

Subject to changes. Please also observe the further product documentation!



## Material Data

Note (material data)

Information on material specifications can be found here

Color	blue
Material group	I
Insulation material	Polyamide (PA66)
Flammability class per UL94	V0
Fire load	0.361 MJ
Weight	15.2 g

## Environmental requirements

Processing temperature	-35 ... +85 °C
Continuous operating temperature	-60 ... +105 °C

## Commercial data

eCl@ss 10.0	27-14-11-20
eCl@ss 9.0	27-14-11-20
ETIM 8.0	EC000897
ETIM 7.0	EC000897
PU (SPU)	25 pcs
Packaging type	box
Country of origin	DE
GTIN	4055143742467
Customs tariff number	85369010000

## Environmental Product Compliance





RoHS Compliance Status	Compliant, No Exemption
------------------------	-------------------------

## Approvals / Certificates



### General approvals

Logo	Approval	Additional Approval Text	Certificate name
	CCA DEKRA Certification B.V.	EN 60947	NTR NL 7678



Subject to changes. Please also observe the further product documentation!

	CCC CNEX	GB/T 3836.3	2020312313000164 (Ex eb IIC Gb, Ex eb I Mb)
	CSA DEKRA Certification B.V.	C22.2	70175103
	KEMA/KEUR DEKRA Certification B.V.	EN 60947	71-103226
	UL Underwriters Laboratories Inc.	UL 1059	E45172

## Declarations of conformity and manufacturer's declarations

Logo	Approval	Additional Approval Text	Certificate name
	EU-Declaration of Conformity WAGO GmbH & Co. KG	-	-
	UK-Declaration of Conformity WAGO GmbH & Co. KG	-	-

## Approvals for marine applications

Logo	Approval	Additional Approval Text	Certificate name
	ABS American Bureau of Shipping	-	19-HG1866350-PDA
	BV Bureau Veritas S.A.	IEC 60947	58186/A0 BV
	DNV GL Det Norske Veritas, Germanischer Lloyd	-	TAE00003JT

Subject to changes. Please also observe the further product documentation!

WAGO GmbH & Co. KG  
Hansastr. 27  
32423 Minden  
Phone: +49571 887-0 | Fax: +49571 887-169  
Email: [info.de@wago.com](mailto:info.de@wago.com) | Web: [www.wago.com](http://www.wago.com)





Do you have any questions about our products?  
We are always happy to take your call at +49 (571) 887-44222.



LR  
Lloyds Register

19/20050



### Approvals for hazardous areas

Logo	Approval	Additional Approval Text	Certificate name
	AEx UL International Germany GmbH c/o Physikalisch Technische Bundesanstalt	UL 60079	E185892 (AEx eb IIC resp. Ex eb IIC)
	ATEX Physikalisch Technische Bundesanstalt	EN 60079-0	PTB 18 ATEX 1011 U (II 2 G Ex eb IIC Gb bzw. I M 2 Ex eb I Mb)
	CCC CNEX	GB/T 3836.3	2020312313000164 (Ex eb IIC Gb, Ex eb I Mb)
	EAC Brjansker Zertifizierungsstelle	TP TC 012/2011	RU C-DE.AM02.B. 00127/19 (Ex e IIC Gb U)
	IECEX Physikalisch Technische Bundesanstalt	IEC 60079-0	IECEX PTB 18.0018U (Ex eb IIC Gb resp. Ex eb I Mb)
	INMETRO TÜV Rheinland do Brasil Ltda.	IEC 60079	TÜV 19.0823 U

### Required accessories

#### End plate

End plate

	Item no.: 2106-1291 End and intermediate plate; 1 mm thick; gray	<a href="http://www.wago.com/2106-1291">www.wago.com/2106-1291</a>
	Item no.: 2106-1292 End and intermediate plate; 1 mm thick; orange	<a href="http://www.wago.com/2106-1292">www.wago.com/2106-1292</a>

Subject to changes. Please also observe the further product documentation!

WAGO GmbH & Co. KG  
Hansastr. 27  
32423 Minden  
Phone: +49571 887-0 | Fax: +49571 887-169  
Email: [info.de@wago.com](mailto:info.de@wago.com) | Web: [www.wago.com](http://www.wago.com)

Do you have any questions about our products?  
We are always happy to take your call at +49 (571) 887-44222.

## Optional accessories

### Tool

#### Operating tool



**Item no.: 210-721**

Operating tool; Blade: 5.5 x 0.8 mm; with a partially insulated shaft; multicoloured

[www.wago.com/210-721](http://www.wago.com/210-721)

### Jumpers

#### Jumper



**Item no.: 2006-402**

Jumper; 2-way; insulated; light gray

[www.wago.com/2006-402](http://www.wago.com/2006-402)

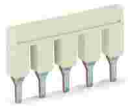

**Item no.: 2006-405**

Jumper; 5-way; insulated; light gray

[www.wago.com/2006-405](http://www.wago.com/2006-405)



**Item no.: 2006-433**

Jumper; from 1 to 3; insulated; light gray

[www.wago.com/2006-433](http://www.wago.com/2006-433)



**Item no.: 2006-403**

Jumper; 3-way; insulated; light gray

[www.wago.com/2006-403](http://www.wago.com/2006-403)



**Item no.: 2006-405/011-000**

Star point jumper; 3-way; insulated; light gray

[www.wago.com/2006-405/011-000](http://www.wago.com/2006-405/011-000)



**Item no.: 2006-404**

Jumper; 4-way; insulated; light gray

[www.wago.com/2006-404](http://www.wago.com/2006-404)



**Item no.: 2006-434**

Jumper; from 1 to 4; insulated; light gray

[www.wago.com/2006-434](http://www.wago.com/2006-434)



**Item no.: 2006-435**

Jumper; from 1 to 5; insulated; light gray

[www.wago.com/2006-435](http://www.wago.com/2006-435)

### Testing and measuring

#### Testing accessories



**Item no.: 2009-174**

Test plug adapter; for 4 mm Ø test plugs; for testing TOPJOB®S rail-mounted terminal blocks; gray

[www.wago.com/2009-174](http://www.wago.com/2009-174)



**Item no.: 2009-182**

Testing tap; for max. 2.5 mm<sup>2</sup>; tool-free connection for individual test wires 0.08 - 2.5 mm; gray

[www.wago.com/2009-182](http://www.wago.com/2009-182)



**Item no.: 2006-511**

Modular TOPJOB®S connector; modular; for jumper contact slot; 1-pole; 6,00 mm<sup>2</sup>; gray

[www.wago.com/2006-511](http://www.wago.com/2006-511)



Subject to changes. Please also observe the further product documentation!

WAGO GmbH & Co. KG

Hansastr. 27

32423 Minden

Phone: +49571 887-0 | Fax: +49571 887-169

Email: [info.de@wago.com](mailto:info.de@wago.com) | Web: [www.wago.com](http://www.wago.com)

Do you have any questions about our products?

We are always happy to take your call at +49 (571) 887-44222.

Item no.: 2006-549

Spacer module; modular; e.g., for bridging commoned terminal blocks; gray

[www.wago.com/2006-549](http://www.wago.com/2006-549)



Item no.: 210-136

Test plug; 2 mm Ø; with 500 mm cable; red

[www.wago.com/210-136](http://www.wago.com/210-136)

Cover

Cover



Item no.: 2006-191

Lockout cap; for wire insertion and actuating opening; gray

[www.wago.com/2006-191](http://www.wago.com/2006-191)

Marking accessories

Marking strip



Item no.: 2009-110

Marking strips; for Smart Printer; on reel; not stretchable; plain; snap-on type; white

[www.wago.com/2009-110](http://www.wago.com/2009-110)

Marker carrier



Item no.: 2009-198

Adaptor; gray

[www.wago.com/2009-198](http://www.wago.com/2009-198)

Marker



Item no.: 2009-115/000-002

WMB-Inline; for Smart Printer; 1500 pieces on roll; stretchable 5 - 5.2 mm; plain; snap-on type; yellow

[www.wago.com/2009-115/000-002](http://www.wago.com/2009-115/000-002)



Item no.: 2009-115/000-007

WMB-Inline; for Smart Printer; 1500 pieces on roll; stretchable 5 - 5.2 mm; plain; snap-on type; gray

[www.wago.com/2009-115/000-007](http://www.wago.com/2009-115/000-007)



Item no.: 2009-115/000-017

WMB-Inline; for Smart Printer; 1500 pieces on roll; stretchable 5 - 5.2 mm; plain; snap-on type; light green

[www.wago.com/2009-115/000-017](http://www.wago.com/2009-115/000-017)



Item no.: 2009-115/000-023

WMB-Inline; for Smart Printer; 1500 pieces on roll; stretchable 5 - 5.2 mm; plain; snap-on type; green

[www.wago.com/2009-115/000-023](http://www.wago.com/2009-115/000-023)



Item no.: 2009-115/000-024

WMB-Inline; for Smart Printer; 1500 pieces on roll; stretchable 5 - 5.2 mm; plain; snap-on type; violet

[www.wago.com/2009-115/000-024](http://www.wago.com/2009-115/000-024)



Item no.: 2009-145/000-006

Mini-WSB Inline; for Smart Printer; 1700 pieces on roll; stretchable 5 - 5.2 mm; plain; snap-on type; blue

[www.wago.com/2009-145/000-006](http://www.wago.com/2009-145/000-006)



Item no.: 2009-145

Mini-WSB Inline; for Smart Printer; 1700 pieces on roll; stretchable 5 - 5.2 mm; plain; snap-on type; white

[www.wago.com/2009-145](http://www.wago.com/2009-145)

Subject to changes. Please also observe the further product documentation!

WAGO GmbH & Co. KG

Hansastr. 27

32423 Minden









Phone: +49571 887-0 | Fax: +49571 887-169

Email: [info.de@wago.com](mailto:info.de@wago.com) | Web: [www.wago.com](http://www.wago.com)

Do you have any questions about our products?

We are always happy to take your call at +49 (571) 887-44222.

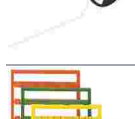
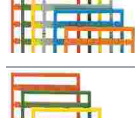
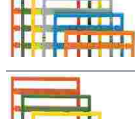
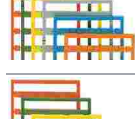
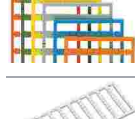

	<b>Item no.: 2009-145/000-002</b> Mini-WSB Inline; for Smart Printer; 1700 pieces on roll; stretchable 5 - 5.2 mm; plain; snap-on type; yellow	<a href="http://www.wago.com/2009-145/000-002">www.wago.com/2009-145/000-002</a>
	<b>Item no.: 2009-145/000-007</b> Mini-WSB Inline; for Smart Printer; 1700 pieces on roll; stretchable 5 - 5.2 mm; plain; snap-on type; gray	<a href="http://www.wago.com/2009-145/000-007">www.wago.com/2009-145/000-007</a>
	<b>Item no.: 2009-145/000-005</b> Mini-WSB Inline; for Smart Printer; 1700 pieces on roll; stretchable 5 - 5.2 mm; plain; snap-on type; red	<a href="http://www.wago.com/2009-145/000-005">www.wago.com/2009-145/000-005</a>
	<b>Item no.: 2009-145/000-012</b> Mini-WSB Inline; for Smart Printer; 1700 pieces on roll; stretchable 5 - 5.2 mm; plain; snap-on type; orange	<a href="http://www.wago.com/2009-145/000-012">www.wago.com/2009-145/000-012</a>
	<b>Item no.: 2009-145/000-023</b> Mini-WSB Inline; for Smart Printer; 1700 pieces on roll; stretchable 5 - 5.2 mm; plain; snap-on type; green	<a href="http://www.wago.com/2009-145/000-023">www.wago.com/2009-145/000-023</a>
	<b>Item no.: 2009-145/000-024</b> Mini-WSB Inline; for Smart Printer; 1700 pieces on roll; stretchable 5 - 5.2 mm; plain; snap-on type; violet	<a href="http://www.wago.com/2009-145/000-024">www.wago.com/2009-145/000-024</a>
	<b>Item no.: 2009-115</b> WMB-Inline; for Smart Printer; 1500 pieces on roll; stretchable 5 - 5.2 mm; plain; snap-on type; white	<a href="http://www.wago.com/2009-115">www.wago.com/2009-115</a>
	<b>Item no.: 248-501/000-006</b> Mini-WSB marking card; as card; not stretchable; plain; snap-on type; blue	<a href="http://www.wago.com/248-501/000-006">www.wago.com/248-501/000-006</a>
	<b>Item no.: 248-501/000-007</b> Mini-WSB marking card; as card; not stretchable; plain; snap-on type; gray	<a href="http://www.wago.com/248-501/000-007">www.wago.com/248-501/000-007</a>
	<b>Item no.: 248-501/000-002</b> Mini-WSB marking card; as card; not stretchable; plain; snap-on type; yellow	<a href="http://www.wago.com/248-501/000-002">www.wago.com/248-501/000-002</a>
	<b>Item no.: 248-501/000-012</b> Mini-WSB marking card; as card; not stretchable; plain; snap-on type; orange	<a href="http://www.wago.com/248-501/000-012">www.wago.com/248-501/000-012</a>
	<b>Item no.: 248-501</b> Mini-WSB marking card; as card; not stretchable; plain; snap-on type; white	<a href="http://www.wago.com/248-501">www.wago.com/248-501</a>

Subject to changes. Please also observe the further product documentation!



**Item no.:** 248-501/000-017  
Mini-WSB marking card; as card; not stretchable; plain; snap-on type; light green

[www.wago.com/248-501/000-017](http://www.wago.com/248-501/000-017)



**Item no.:** 248-501/000-005  
Mini-WSB marking card; as card; not stretchable; plain; snap-on type; red

[www.wago.com/248-501/000-005](http://www.wago.com/248-501/000-005)



**Item no.:** 248-501/000-024  
Mini-WSB marking card; as card; not stretchable; plain; snap-on type; violet

[www.wago.com/248-501/000-024](http://www.wago.com/248-501/000-024)



**Item no.:** 248-501/000-023  
Mini-WSB marking card; as card; not stretchable; plain; snap-on type; green

[www.wago.com/248-501/000-023](http://www.wago.com/248-501/000-023)



**Item no.:** 793-5501/000-007  
WMB marking card; as card; for terminal block width 5 - 17.5 mm; stretchable 5 - 5.2 mm; plain; snap-on type; gray

[www.wago.com/793-5501/000-007](http://www.wago.com/793-5501/000-007)



**Item no.:** 793-5501/000-012  
WMB marking card; as card; for terminal block width 5 - 17.5 mm; stretchable 5 - 5.2 mm; plain; snap-on type; orange

[www.wago.com/793-5501/000-012](http://www.wago.com/793-5501/000-012)



**Item no.:** 793-5501/000-017  
WMB marking card; as card; for terminal block width 5 - 17.5 mm; stretchable 5 - 5.2 mm; plain; snap-on type; light green

[www.wago.com/793-5501/000-017](http://www.wago.com/793-5501/000-017)



**Item no.:** 793-5501/000-023  
WMB marking card; as card; for terminal block width 5 - 17.5 mm; stretchable 5 - 5.2 mm; plain; snap-on type; green

[www.wago.com/793-5501/000-023](http://www.wago.com/793-5501/000-023)



**Item no.:** 793-5501/000-024  
WMB marking card; as card; for terminal block width 5 - 17.5 mm; stretchable 5 - 5.2 mm; plain; snap-on type; violet

[www.wago.com/793-5501/000-024](http://www.wago.com/793-5501/000-024)



**Item no.:** 793-501/000-002  
WMB marking card; as card; not stretchable; plain; snap-on type; yellow

[www.wago.com/793-501/000-002](http://www.wago.com/793-501/000-002)



**Item no.:** 793-501/000-007  
WMB marking card; as card; not stretchable; plain; snap-on type; gray

[www.wago.com/793-501/000-007](http://www.wago.com/793-501/000-007)

Subject to changes. Please also observe the further product documentation!



Item no.: 793-501/000-017

WMB marking card; as card; not stretchable; plain; snap-on type; light green

[www.wago.com/793-501/000-017](http://www.wago.com/793-501/000-017)



Item no.: 793-501/000-012

WMB marking card; as card; not stretchable; plain; snap-on type; orange

[www.wago.com/793-501/000-012](http://www.wago.com/793-501/000-012)



Item no.: 793-501/000-023

WMB marking card; as card; not stretchable; plain; snap-on type; green

[www.wago.com/793-501/000-023](http://www.wago.com/793-501/000-023)



Item no.: 793-501/000-006

WMB marking card; as card; not stretchable; plain; snap-on type; blue

[www.wago.com/793-501/000-006](http://www.wago.com/793-501/000-006)



Item no.: 793-501/000-005

WMB marking card; as card; not stretchable; plain; snap-on type; red

[www.wago.com/793-501/000-005](http://www.wago.com/793-501/000-005)



Item no.: 793-501

WMB marking card; as card; not stretchable; plain; snap-on type; white

[www.wago.com/793-501](http://www.wago.com/793-501)



Item no.: 793-501/000-024

WMB marking card; as card; not stretchable; plain; snap-on type; violet

[www.wago.com/793-501/000-024](http://www.wago.com/793-501/000-024)



Item no.: 793-5501/000-005

WMB marking card; as card; for terminal block width 5 - 17.5 mm; stretchable 5 - 5.2 mm; plain; snap-on type; red

[www.wago.com/793-5501/000-005](http://www.wago.com/793-5501/000-005)



Item no.: 793-5501/000-002

WMB marking card; as card; for terminal block width 5 - 17.5 mm; stretchable 5 - 5.2 mm; plain; snap-on type; yellow

[www.wago.com/793-5501/000-002](http://www.wago.com/793-5501/000-002)



Item no.: 793-5501/000-006

WMB marking card; as card; for terminal block width 5 - 17.5 mm; stretchable 5 - 5.2 mm; plain; snap-on type; blue

[www.wago.com/793-5501/000-006](http://www.wago.com/793-5501/000-006)



Item no.: 793-5501

WMB marking card; as card; for terminal block width 5 - 17.5 mm; stretchable 5 - 5.2 mm; plain; snap-on type; white

[www.wago.com/793-5501](http://www.wago.com/793-5501)

Subject to changes. Please also observe the further product documentation!

WAGO GmbH & Co. KG

Hansastr. 27

32423 Minden

Phone: +49571 887-0 | Fax: +49571 887-169

Email: [info.de@wago.com](mailto:info.de@wago.com) | Web: [www.wago.com](http://www.wago.com)

Do you have any questions about our products?

We are always happy to take your call at +49 (571) 887-44222.

	<b>Item no.: 2009-115/000-012</b> WMB-Inline; for Smart Printer; 1500 pieces on roll; stretchable 5 - 5.2 mm; plain; snap-on type; orange	<a href="http://www.wago.com/2009-115/000-012">www.wago.com/2009-115/000-012</a>
---	--	--

	<b>Item no.: 2009-115/000-006</b> WMB-Inline; for Smart Printer; 1500 pieces on roll; stretchable 5 - 5.2 mm; plain; snap-on type; blue	<a href="http://www.wago.com/2009-115/000-006">www.wago.com/2009-115/000-006</a>
---	--	--

## Group marker carrier

	<b>Item no.: 2009-193</b> Group marker carrier; gray	<a href="http://www.wago.com/2009-193">www.wago.com/2009-193</a>
--	---	--

	<b>Item no.: 2009-192</b> Group marker carrier; gray	<a href="http://www.wago.com/2009-192">www.wago.com/2009-192</a>
--	---	--

	<b>Item no.: 2009-191</b> Group marker carrier; gray	<a href="http://www.wago.com/2009-191">www.wago.com/2009-191</a>
--	---	--

## Ferrule

## Ferrule

	<b>Item no.: 216-208</b> Ferrule; Sleeve for 6 mm <sup>2</sup> / AWG 10; insulated; electro-tin plated; electrolytic copper; gastight crimped; acc. to DIN 46228, Part 4/09.90; yellow	<a href="http://www.wago.com/216-208">www.wago.com/216-208</a>
--	---	--

	<b>Item no.: 216-263</b> Ferrule; Sleeve for 1 mm <sup>2</sup> / AWG 18; insulated; electro-tin plated; electrolytic copper; gastight crimped; acc. to DIN 46228, Part 4/09.90; red	<a href="http://www.wago.com/216-263">www.wago.com/216-263</a>
--	--	--

	<b>Item no.: 216-266</b> Ferrule; Sleeve for 2.5 mm <sup>2</sup> / AWG 14; insulated; electro-tin plated; electrolytic copper; gastight crimped; acc. to DIN 46228, Part 4/09.90; blue	<a href="http://www.wago.com/216-266">www.wago.com/216-266</a>
--	---	--

	<b>Item no.: 216-264</b> Ferrule; Sleeve for 1.5 mm <sup>2</sup> / AWG 16; insulated; electro-tin plated; electrolytic copper; gastight crimped; acc. to DIN 46228, Part 4/09.90; black	<a href="http://www.wago.com/216-264">www.wago.com/216-264</a>
--	--	--

	<b>Item no.: 216-262</b> Ferrule; Sleeve for 0.75 mm <sup>2</sup> / 18 AWG; insulated; electro-tin plated; electrolytic copper; gastight crimped; acc. to DIN 46228, Part 4/09.90; gray	<a href="http://www.wago.com/216-262">www.wago.com/216-262</a>
--	--	--

	<b>Item no.: 216-267</b> Ferrule; Sleeve for 4 mm <sup>2</sup> / AWG 12; insulated; electro-tin plated; electrolytic copper; gastight crimped; acc. to DIN 46228, Part 4/09.90; gray	<a href="http://www.wago.com/216-267">www.wago.com/216-267</a>
--	---	--

## Mounting

## Cover carrier

	<b>Item no.: 709-169</b> Cover carrier; Type 3; gray	<a href="http://www.wago.com/709-169">www.wago.com/709-169</a>
--	---	--









## Cover

	<b>Item no.: 709-156</b> Cover; Type 3; suitable for cover carrier, type 3; 1 m long; transparent	<a href="http://www.wago.com/709-156">www.wago.com/709-156</a>
--	--	--

## Carrier rail

Subject to changes. Please also observe the further product documentation!

Mounting accessories

	<b>Item no.: 210-197</b> Steel carrier rail; 35 x 15 mm; 1.5 mm thick; 2 m long; slotted; similar to EN 60715; silver-colored	<a href="http://www.wago.com/210-197">www.wago.com/210-197</a>
	<b>Item no.: 210-198</b> Copper carrier rail; 35 x 15 mm; 2.3 mm thick; 2 m long; unslotted; according to EN 60715; copper-colored	<a href="http://www.wago.com/210-198">www.wago.com/210-198</a>
	<b>Item no.: 210-113</b> Steel carrier rail; 35 x 7.5 mm; 1 mm thick; 2 m long; unslotted; according to EN 60715; silver-colored	<a href="http://www.wago.com/210-113">www.wago.com/210-113</a>
	<b>Item no.: 210-118</b> Steel carrier rail; 35 x 15 mm; 2.3 mm thick; 2 m long; unslotted; according to EN 60715; silver-colored	<a href="http://www.wago.com/210-118">www.wago.com/210-118</a>
	<b>Item no.: 210-112</b> Steel carrier rail; 35 x 7.5 mm; 1 mm thick; 2 m long; slotted; according to EN 60715; "Hole width 25 mm; silver-colored	<a href="http://www.wago.com/210-112">www.wago.com/210-112</a>
	<b>Item no.: 210-114</b> Steel carrier rail; 35 x 15 mm; 1.5 mm thick; 2 m long; unslotted; similar to EN 60715; silver-colored	<a href="http://www.wago.com/210-114">www.wago.com/210-114</a>
	<b>Item no.: 210-115</b> Steel carrier rail; 35 x 7.5 mm; 1 mm thick; 2 m long; slotted; according to EN 60715; "Hole width 18 mm; silver-colored	<a href="http://www.wago.com/210-115">www.wago.com/210-115</a>
	<b>Item no.: 210-196</b> Aluminum carrier rail; 35 x 8.2 mm; 1.6 mm thick; 2 m long; unslotted; similar to EN 60715; silver-colored	<a href="http://www.wago.com/210-196">www.wago.com/210-196</a>

Downloads

Documentation

Bid Text

2106-5204 docx - Datei	2019 Apr 15	docx 15.0 kB	Download
2106-5204 X81 - Datei	2019 Apr 15	xml 4.1 kB	Download

Additional Information

Technical Section Technical explanations	pdf 2.2 MB	Download
---	---------------	----------

CAD/CAE-Data

CAD data

Subject to changes. Please also observe the further product documentation!

WAGO GmbH & Co. KG  
Hansastr. 27  
32423 Minden  
Phone: +49571 887-0 | Fax: +49571 887-169  
Email: [info.de@wago.com](mailto:info.de@wago.com) | Web: [www.wago.com](http://www.wago.com)

Do you have any questions about our products?  
We are always happy to take your call at +49 (571) 887-44222.

2D/3D Models 2106-5204

[URL](#)

[Download](#)

#### CAE data

EPLAN Data Portal 2106-5204

[URL](#)

[Download](#)

ZUKEN Portal 2106-5204

[URL](#)

[Download](#)

## Environmental Product Compliance

### Compliance Search

Environmental Product Compliance 2106-5204

[URL](#)

[Download](#)

2-conductor through terminal block; with lever and push-button; 6 mm<sup>2</sup>; with test port; suitable for Ex i applications; side and center marking; for DIN-rail 35 x 15 and 35 x 7.5; Push-in CAGE CLAMP®; 6,00 mm<sup>2</sup>; blue

## Installation Notes

### Conductor termination

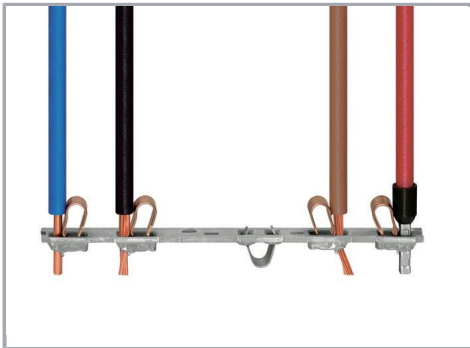

All conductor types at a glance

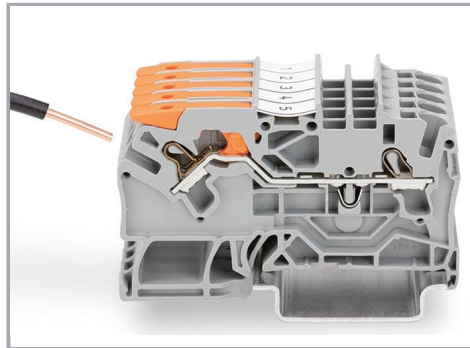

Push-in termination of solid conductors

Subject to changes. Please also observe the further product documentation!

WAGO GmbH & Co. KG

Hansastr. 27

32423 Minden

Phone: +49571 887-0 | Fax: +49571 887-169

Email: [info.de@wago.com](mailto:info.de@wago.com) | Web: [www.wago.com](http://www.wago.com)

Do you have any questions about our products?

We are always happy to take your call at +49 (571) 887-44222.

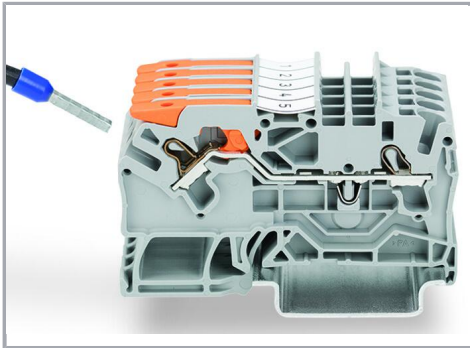

Push-in termination of fine-stranded conductors with ferrules

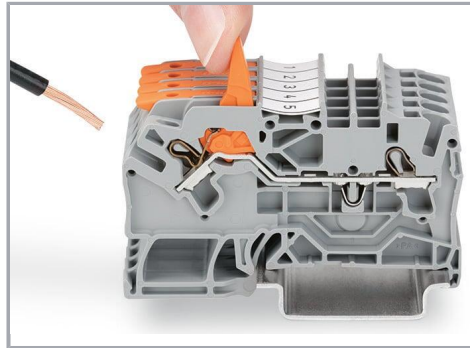

Pull the lever up until it stops, then connect the fine-stranded conductor.

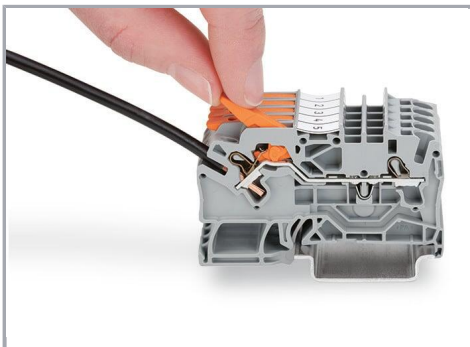

Push the lever back down – done!

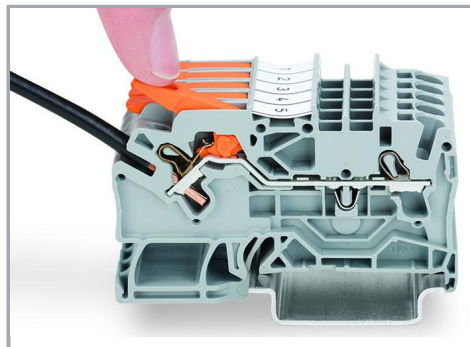

Push the lever back down – done!

### Commoning



Insert a push-in type jumper bar and push down until it hits the backstop.

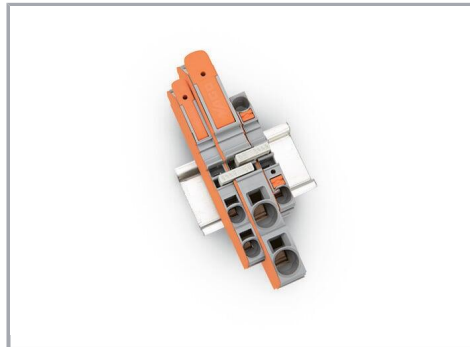

Commoning with step-down jumpers.

### Testing

Subject to changes. Please also observe the further product documentation!

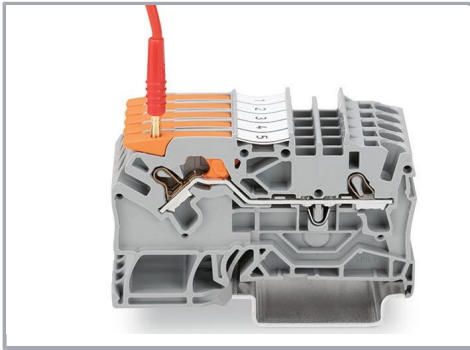

Testing with a 2 mm Ø test plug (max. 42 V).

### Marking

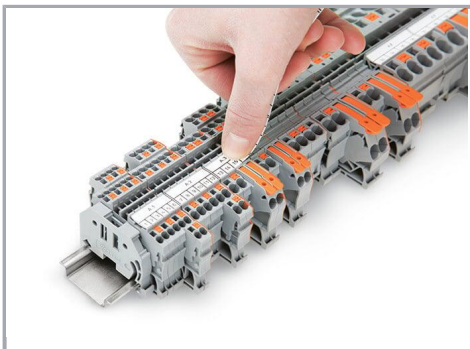

Snapping a marking strip into a marker slot.



Snapping a marking strip into the marker slot.

### Product family

#### TOPJOB® S

TOPJOB® S: In various industrial applications and modern building installations, WAGO's wide and versatile range of rail-mount terminal blocks provides more than just reliable electrical connections.

[Show all products from the family](#)

Subject to changes. Please also observe the further product documentation!