

› Logic Controller Millenium Evo

- › Up to 44 I/Os - Base 16 DI (4 HighSpeed/8 AI) - 8 DO
- › Wireless programming & control with bluetooth Interface and Crouzet Virtual Display
- › Ethernet Modbus TCP/IP (Client/Server) and Modbus RTU Network via interface (Slave)
- › Event and Datalog Management via mail/FTP server or Locally
- › Up to 1000 programing blocks with intuitive Crouzet Soft to go from simple to complex applications



Product selection			
Type	LCD display	Ethernet network	Part number
XBP24	No	No	88 975 001
XBP24-E	No	Yes	88 975 011
XDP24	Yes	No	88 975 101
XDP24-E	Yes	Yes	88 975 111

Accessories	
Accessories Description	Part-number
USB Interface	88 980 110
USB cable 3m B type	88 980 170
Kit Description	Part-number
MilleniumEVO STARTER KIT, Logic Controller + Bluetooth interface	88 975 901
MilleniumEVO STARTER KIT, Logic Controller with embedded Ethernet + Bluetooth interface	88 975 911
MilleniumEVO KIT XDP24-E + Crouzet Touch CTP104-E Performance, Ethernet, USB Key	88 970 558
MilleniumEVO KIT XDP24-E + Crouzet Touch CTP107-E Performance, Ethernet, USB Key	88 970 568

	XBP24	XBP24-E	XDP24	XDP24-E
General features				
Ethernet Modbus TCP/IP (Client///Server)	-	Yes (16 IP range /// 16 words + 8bits)	-	Yes (16 IP range /// 16 words + 8bits)
Modbus RTU RS485 (Salve)	Yes via interface (16 words + 8 bits)			
Datalog via mail or FTP	-	Yes (16 data channel; 32 000 recording)	-	Yes (16 data channel; 32 000 recording)
Datalog local	Yes (16 data channel; 6 000 recording)	-	Yes (16 data channel; 6 000 recording)	-
Event mangement via mail	-	Yes (12 events)	-	Yes (12 events)
Bluetooth	Yes via interface			
General characteristics				
Products certification	CE, cULus Listed			
Conformity with the low voltage directive (in accordance with 2014/35/EU)	IEC/EN 61131-2 (Open equipment)			
Conformity with the EMC directive (in accordance with 2014/30/EU)	IEC/EN 61000-6-1 (Residential, commercial and light-industrial environments) IEC/EN 61000-6-2 (Industrial) IEC/EN 61000-6-3 (Residential, commercial and light-industrial environments) IEC/EN 61000-6-4 (Industrial)			

	XBP24	XBP24-E	XDP24	XDP24-E
Power supply earthing	None			
Overvoltage category	3 in accordance with IEC/EN 60664-1			
Pollution	Degree: 2 in accordance with IEC/EN 61131-2			
Maximum utilization altitude	Operation: 2000 m Transport: 3000 m			
Mechanical resistance	Immunity to vibrations IEC/EN 60068-2-6, Fc test Immunity to shock IEC/EN 60068-2-27, Ea test			
Resistance to electrostatic discharge	Immunity to ESD IEC/EN 61000-4-2, level 3			
Resistance to HF interference (Immunity)	Immunity to radiated electrostatic fields IEC/EN 61000-4-3, level 3 Immunity to fast transients (burst immunity) IEC/EN 61000-4-4, level 3 Immunity to shock waves IEC/EN 61000-4-5 Radio frequency in common mode IEC/EN 61000-4-6, level 3			
Conducted and radiated emissions (in accordance with EN 55022/11 group 1)	Class B			
Operation temperature	-20 °C (-4 °F) → +60 °C (140 °F) (+40 °C (104 °F) in a non-ventilated enclosure) UL: maximum surrounding air: +50 °C (122 °F)			
Storage temperature	-40 °C (-40 °F) → +80 °C (176 °F)			
Relative humidity	95% max. (no condensation or dripping water)			
Screw terminals connection capacity	Flexible wire with ferrule: 1 conductor: 0.2 to 2.5 mm ² (AWG 24-14) Flexible wire with ferrule: 2 conductors: 0.2 to 0.75 mm ² (AWG 24-18) Rigid wire: 1 conductor: 0.2 to 2.5 mm ² (AWG 24-14) Rigid wire: 2 conductors: 0.2 to 0.75 mm ² (AWG 24-18) Tightening torque: 0.5 N.m (4.5 lb-in) (tighten using screwdriver diam. 3.5 mm) Stripping length: 6 mm			
Material	Lexan, UL94V0			
Environnement	Reach, RoHS, Halogen free 1272/2008/CE			
On front panel color	Grey RAL 7035			
On sole color	Black RAL 9011			
Protection rating (in accordance with IEC/EN 60529)	IP 40 on front panel IP 20 on terminal block			
Weight	Without packing: 270 g With packing: 320 g	Without packing: 300 g With packing: 350 g	Without packing: 330 g With packing: 380 g	
Dimensions	Without packing: 124.6 x 90 x 61.1 mm / 4.91 x 3.54 x 2.4 inch With packing: 148 x 103 x 65 mm / 5.83 x 4.06 x 2.56 inch		Without packing: 124.6 x 90 x 62 mm / 4.91 x 3.54 x 2.44 inch With packing: 148 x 103 x 65 mm / 5.83 x 4.06 x 2.56 inch	

Processing characteristics				
LCD display	Without		Display with 4 lines of 18 characters, yellow/green	
Programming method	FBD (Function Block Diagram), including SFC (Sequential Function Chart) (Grafcet)			
Program size	Function blocks: typically 512 blocks Macro blocks: 127 max. (255 blocks per macro)			
Program memory	Flash			
Removable memory	N.A			
Data memory	2 k octets			
Back-up time (in the event of power failure)	Program and settings in the controller: 10 years Data memory: 10 years			
Data back-up	Data backup in the flash memory is guaranteed if the product is powered on more than 10 seconds			
Cycle time	From 2 ms* to 90 ms, default value: 10 ms *: Depending on configuration			
Clock data retention	10 years (lithium battery) at 25 °C (77 °F)			
Clock drift	Drift < 12 min/year (at 25 °C (77 °F)) 6 s / month (at 25 °C (77 °F) with user-definable correction of drift). Synchronizable by network			

	XBP24	XBP24-E	XDP24	XDP24-E
Timer block accuracy	0.5 % ± 2 cycle time			
Start up time on power up	< 8 s base alone, < 5 s base + 2 expansions + 1 accessory (RS485)	< 10 s base alone, < 5 s base + 2 expansions + 1 accessory (RS485)	< 8 s base alone, < 5 s base + 2 expansions + 1 accessory (RS485)	< 10 s base alone, < 5 s base + 2 expansions + 1 accessory (RS485)
Self test	Test firmware integrity (checksum memory) Stability of the internal power supply Check the conformity of the em4 device configuration with the configuration in the application program.			

Supply

Nominal voltage	24 V _{DC} (-15% / +20%)			
Operating limits	20.4 - 28.8 V _{DC}			
Immunity from micro power cuts	≤ 1 ms (repetition 20 times)			
Max. absorbed power	3.8 W @ 24 V _{DC} , 5 W @ 28.8 V _{DC} , 1.5 W @ 24 V _{DC} I/O OFF	4.8W @ 24 V _{DC} , 6.2 W @ 28.8 V _{DC} , 1.5W @ 24 V _{DC} I/O OFF	4W @ 24 V _{DC} , 5.3 W @ 28.8 V _{DC} , - 0.3 W backlight OFF 1.5W @ 24 V _{DC} (I/O + backlight) OFF	5W @ 24 V _{DC} , 6.5 W @ 28.8 V _{DC} , - 0.3 W backlight OFF 1.5W @ 24 V _{DC} (I/O + backlight) OFF
Protection against polarity inversions	Yes			
Power monitoring	Yes and value available through the application "FB Status", 1/10V, 5%.			

Inputs

Digital and high speed digital inputs 24 V_{DC} - 4 inputs from I1 to I4

Input used as digital input

Input voltage	24 V _{DC} (-15% / +20%)			
Input current	1.8 mA @ 20.4 V 2.1 mA @ 24 V 2.5 mA @ 28.8 V			
Input impedance	11.6 kΩ			
Logic 1 voltage threshold	≥ 15 V _{DC}			
Making current at logic state 1	≥ 1.3 mA			
Logic 0 voltage threshold	≤ 10 V _{DC}			
Release current at logic state 0	≤ 0.8 mA			
Response time	1 to 2 cycle times			
Sensor type	Contact or 3-wire PNP			
Conforming to IEC/EN 61131-2	Type 1			
Input type	Resistive			
Isolation between power supply and inputs	None			
Isolation between inputs	None			
Protection against polarity inversions	Yes			
Status indicator	No		On LCD screen	On LCD screen
Cable length	≤ 30 m	≤ 30 m		

Input used as high speed digital input

Maximum counting frequency	3 channels encoder (I1, I2, I3): 5 kHz* 2 independent counters (I1, I2) (I3, I4) (Cumul, IND, DIR): 2 channels: 10 kHz*, 4 channels: 5 kHz*, 2 independent counters (I1, I2) (I3, I4) (PH, PH2): 2/4 channels: 5 kHz* 4 independent counters (I1, I2, I3, I4) (Up/Down): 1 channel: 15 kHz*, 2 channels: 10 kHz*, > 2 channels: 5 kHz* * with a time cycle ≤ 10 ms and a ton / toff = 50% ± 5%, level 0 < 2V and level 1 > 20.4V			
Other functions	4 tachometers (I1, I2, I3, I4)			
Cable length	≤ 3 m with shielded twisted cable			

	XBP24	XBP24-E	XDP24	XDP24-E
Digital 24 V_{DC} and analog inputs 12 bits / 28.8 V - potentiometer - 8 inputs from I5 to IC				
Input used as digital input				
Input voltage	24 V _{DC} (-15% / +20%)			
Input current	1.8 mA @ 20.4 V 2.1 mA @ 24 V 2.5 mA @ 28.8 V			
Input impedance	11.6 kΩ			
Logic 1 voltage threshold	≥ 11 V _{DC}			
Making current at logic state 1	≥ 1 mA			
Logic 0 voltage threshold	≤ 9 V _{DC}			
Release current at logic state 0	≤ 0.7 mA			
Response time	1 to 2 cycle times			
Sensor type	Contact or 3-wire PNP			
Conforming to IEC/EN 61131-2	Type 1			
Input type	Resistive			
Isolation between power supply and inputs	None			
Isolation between inputs	None			
Protection against polarity inversions	Yes			
Status indicator	No		On LCD screen	On LCD screen
Cable length	≤ 30 m			
Input used as analog input				
Measuring range	0 → 10 V, 0 → V power supply or Voltmeter			
Input impedance	11.6 kΩ			
Maximum value without destruction	28.8 V _{DC} max			
Input type	Common mode			
Resolution	12 bit at maximum input voltage (10 bit at 10V)			
Value of LSB	7.03 mV			
Conversion time	Controller cycle time			
Maximum error in 0-10V mode	± 3.5 % of full scale at 25 °C (77 °F) ± 5 % of full scale at 55 °C (131 °F)			
Maximum error in 0-V power supply mode	± 5 % of full scale at 25 °C (77 °F) ± 6.2 % of full scale at 55 °C (131 °F)			
Repeat accuracy at 55 °C (131 °F)	± 2 %			
Voltmeter	From 0 to 30.5 V, 5%			
Isolation between analogue channel and power supply	None			
Protection against polarity inversions	Yes			
Potentiometer control	2.2 kΩ / 0.5 W (recommended), 10 KΩ max.			
Cable length	≤ 10 m with shielded twisted cable (sensor not isolated)			
Digital 24 V_{DC} - 4 inputs from ID to IG				
Input voltage	24 V _{DC} (-15% / +20%)			
Input current	1.5 mA @ 20.4 V 1.7 mA @ 24 V 2.1 mA @ 28.8 V			
Input impedance	13.9 kΩ			
Logic 1 voltage threshold	≥ 11 V _{DC}			
Making current at logic state 1	≥ 0.8 mA			
Logic 0 voltage threshold	≤ 8 V _{DC}			
Release current at logic state 0	≤ 0.5 mA			
Response time	1 to 2 cycle times			
Sensor type	Contact or 3-wire PNP			

	XBP24	XBP24-E	XDP24	XDP24-E
Conforming to IEC/EN 61131-2	Type 1			
Input type	Resistive			
Isolation between power supply and inputs	None			
Isolation between inputs	None			
Protection against polarity inversions	No			
Status indicator	No		On LCD screen	On LCD screen
Cable length	≤ 30 m			

Outputs

6 A relay output - 2 outputs from O1 to O2

Breaking voltage	250 V \sim max			
Breaking current	6 A Derating: UL: ≥ 45 °C (113 °F): 4A max			
Maximum breaking current in the common	IEC @ 25 °C (77 °F): 12 A IEC @ 60 °C (140 °F) or UL: 10 A			
Mechanical life	5 000 000 operations (cycles)			
Electrical durability for 50 000 operating cycles	24 V --- tau = 0 ms: 6 A, tau = 7 ms: 3 A, tau = 15 ms: 1.8 A Usage category DC-12: 24 V, 6 A Usage category DC-14: 24 V, 1.8 A 250 V \sim cos phi = 1: 6 A, cos phi = 0.7: 5 A, cos phi = 0.4: 2.5 A Usage category AC-12: 250 V, 6 A Usage category AC-13: 250 V, 5 A Usage category AC-15: 250 V, 2 A			
Minimum switching capacity	100 mA (at minimum voltage of 12V)			
Maximum operating rate	Off load: 10 Hz At operating current: 0.1 Hz			
Voltage for withstanding shocks	In accordance with IEC/EN 60947-1 and IEC/EN 60664-1: 4 kV			
Response time	Make = 1 cycle time + 8 ms typical Release = 1 cycle time + 4 ms typical			
Built-in protections	Against short-circuits: None Against over voltages and overload: None			
Status indicator	No		On LCD screen	On LCD screen
Cable length	≤ 30 m			

8 A relay output - 6 outputs from O3 to O8

Breaking voltage	250 V \sim max			
Breaking current	8 A Derating: CEI ≥ 55 °C (131 °F) or UL: ≥ 45 °C (113 °F): 6A max			
Maximum breaking current in the common	IEC @ 25 °C (77 °F): C3, C6: 8A; C4, C5: 16 A IEC @ 60 °C (140 °F) or UL: C3, C6: 8 A; C4, C5: 10 A			
Mechanical life	20 000 000 operations (cycles)			
Electrical durability for 50 000 operating cycles	24 V --- tau = 0 ms: 8 A, tau = 7 ms: 3 A, tau = 15 ms: 1.5 A Usage category DC-12: 24 V, 8 A Usage category DC-14: 24 V, 1.5 A 250 V \sim cos phi = 1: 8 A, cos phi = 0.7: 4.75 A, cos phi = 0.4: 3 A Usage category AC-12: 250 V, 8 A Usage category AC-13: 250 V, 4.3 A Usage category AC-15: 250 V, 1.5 A			
Minimum switching capacity	100 mA (at minimum voltage of 12V)			
Maximum operating rate	Off load: 10 Hz At operating current: 0.1 Hz			
Voltage for withstanding shocks	In accordance with IEC/EN 60947-1 and IEC/EN 60664-1: 4 kV			
Response time	Make = 1 cycle time + 10 ms typical Release = 1 cycle time + 5 ms typical			
Built-in protections	Against short-circuits: None Against over voltages and overload: None			

	XBP24	XBP24-E	XDP24	XDP24-E
Status indicator	No		On LCD screen	On LCD screen
Cable length	≤ 30 m			

Ethernet network				
Programming / exploitation	-	USB & Ethernet port / Ethernet port	-	USB & Ethernet port / Ethernet port
Ethernet connection	-	Type RJ45, 10/100 Mbit/s, MDI/MDIX	-	Type RJ45, 10/100 Mbit/s, MDI/MDIX
Adressage	-	Static or dynamic (DHCP server / Auto IP)	-	Static or dynamic (DHCP server / Auto IP)
Protocols	-	Modbus TCP (client / server), Discovery, UDP, TCP, SMTP, SSL (workshop communication via Ethernet)	-	Modbus TCP (client / server), Discovery, UDP, TCP, SMTP, SSL (workshop communication via Ethernet)
Cable length	-	Maximum length between 2 devices: 100 m / 3937 inch	-	Maximum length between 2 devices: 100 m / 3937 inch
Ethernet earthing	-	Yes, refer to the quick reference guide supplied with the product	-	Yes, refer to the quick reference guide supplied with the product

Technical sketches
Dimensions (mm)

XBP24	XBP24-E	XDP24	XDP24-E
-------	---------	-------	---------

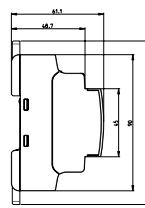
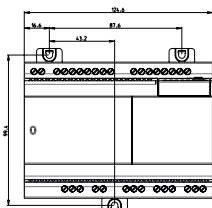

Connections
INPUTS

I1 ... IG 0/1

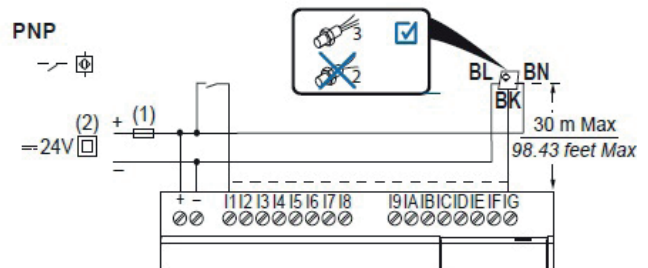
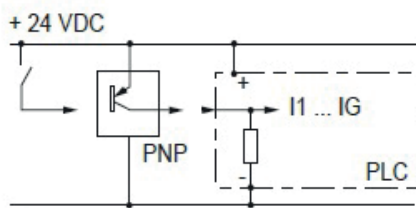

I5 ... IC U

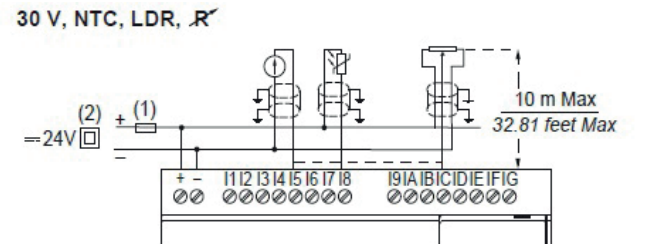
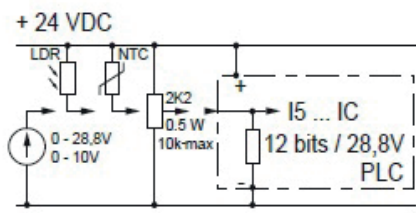

I1 ... I4

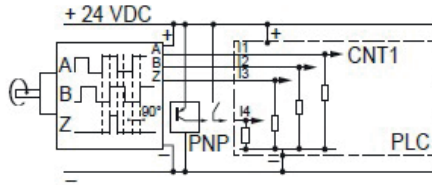

Hz

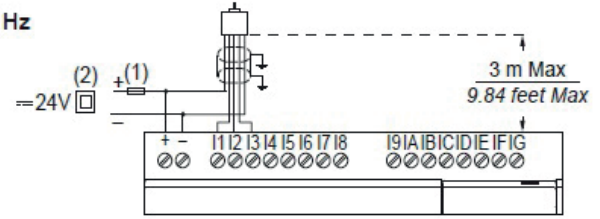

I1 ... I4

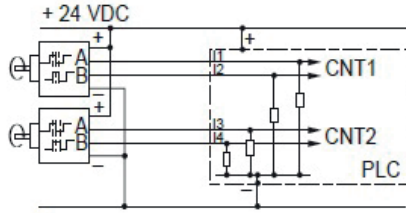

Hz

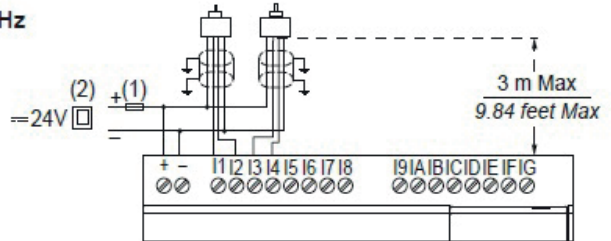

I1 ... I4

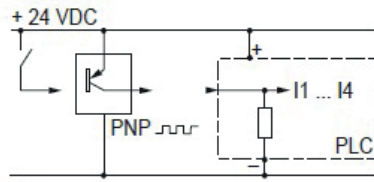

Hz, Rpm

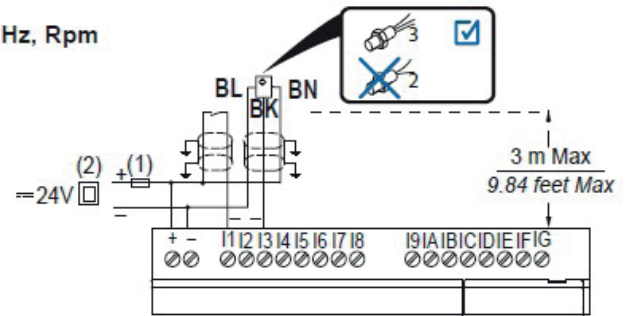

OUTPUTS

O1 ... O8

≈ 12...240V 50/60Hz = 12...24V

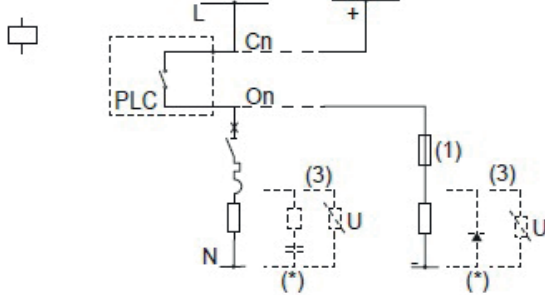

6 A, 8 A

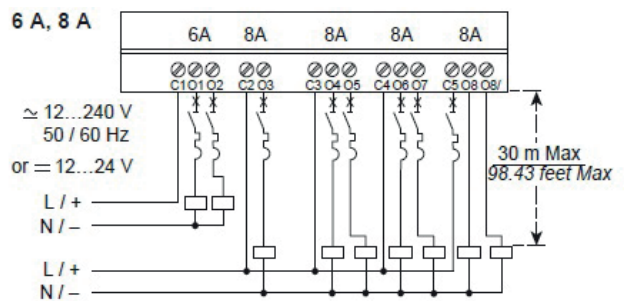

Warning:

The product information contained in this catalogue is given purely as information and does not constitute a representation, warranty or any form of contractual commitment. Crouzet and its subsidiaries reserve the right to modify their products without notice. It is imperative that we should be consulted over any particular use or application of our products and it is the responsibility of the buyer to establish, particularly through all the appropriate tests, that the product is suitable for the use or application. Under no circumstances will our warranty apply, nor shall we be held responsible for any application (such as any modification, addition, deletion, use in conjunction with other electrical or electronic components, circuits or assemblies, or any other unsuitable material or substance) which has not been expressly agreed by us prior to the sale of our products.