

# WLC60 Heavy Duty Stainless Steel LED Light

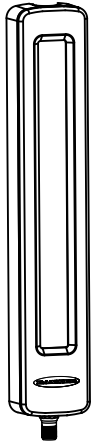

## Datasheet



Banner's WLC60 Heavy Duty Stainless Steel LED Lights are engineered to withstand harsh environments, making it the first choice for a machine lighting solution. A conservative mechanical design protects against liquid ingress and state-of-the-art LED technology delivers best of class brightness.

Choose between a durable polycarbonate window or a borosilicate glass (BSG) option featuring enhanced chemical and thermal resistance. This smart industrial lighting solution also features energy efficient eco-mode dimming states to tailor the lumen levels and power consumption to the application.

- Rugged and durable for harsh environments
- Oil, chemical, and water resistant with IEC IP67, JIS C IP68G, and IP69K per DIN 40050-9 ratings
- High brightness paired with advanced glare-reducing optics
- Easy to install with a wide variety of mounting solutions
- Highly resistant to vibration and shock
- Input voltage of 12 V dc to 30 V dc
- Integral 4-pin M12 Euro-style quick disconnect connector; mating cable required
- Models have four discrete intensity level settings



**Important:** Read the following instructions before operating the light. Please download the complete WLC60 Heavy Duty Stainless Steel LED Light technical documentation, available in multiple languages, from [www.bannerengineering.com](http://www.bannerengineering.com) for details on the proper use, applications, Warnings, and installation instructions of this device.



**Important:** Lea el siguiente instructivo antes de operar el luminario. Por favor descargue desde [www.bannerengineering.com](http://www.bannerengineering.com) toda la documentación técnica de los WLC60 Heavy Duty Stainless Steel LED Light, disponibles en múltiples idiomas, para detalles del uso adecuado, aplicaciones, advertencias, y las instrucciones de instalación de estos dispositivos.

## Models

Model	Window	Lighted Length (mm)
WLC60XW340SSQ	Polycarbonate	340
WLC60XW340GSSQ	Borosilicate Glass	

## Spacing Criteria (SC)

The spacing criteria is the fixture-spacing-to-mounting-height ratio and aids in laying out a pattern of fixtures. Multiply the spacing criteria by the mounting height to get the maximum fixture spacing that still provides even illumination (no shadowing between fixtures).

Luminaire Spacing = SC × Height to Illuminated Plane

The mounting height is the distance from the fixture to the surface you are lighting.

## Wiring Diagram

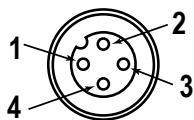

### Key

- Pin 1 Brown: 12-30 V dc
- Pin 3 Blue: dc Common
- Pin 4 Black: Connect to 12-30V dc for 66% max. intensity
- Pin 2 White: Connect to 12-30 V dc for 33% max. intensity
- Pins 4 and 2 Black and White: Connect to 12-30 V dc for 50% intensity



For maximum intensity, leave the white and black wires floating or connected to common.

## Specifications

### Supply Voltage

Operating Voltage: 12 V dc to 30 V dc  
 Use only with a suitable Class 2 power supply (UL) or SELV power supply (CE)  
 See electrical characteristics on product label

### Max. Current

1.53 A at 12 V dc  
 0.68 A at 24 V dc  
 0.55 A at 30 V dc  
 Max. Input Power: 18.4 Watts

### Typical Current

1.38 A at 12 V dc  
 0.62 A at 24 V dc  
 0.49 A at 30 V dc

### Supply Protection Circuitry

Protected against reverse polarity and transient voltages

### Construction

316L stainless steel housing  
 Polycarbonate or borosilicate glass window  
 Buna o-ring seals (consult factory for additional seal)

### Connections

Integral 4-pin M12/Euro-style male quick disconnect  
 Mating cordset required for quick disconnect models

### Storage Temperature

-40 °C to +70 °C (-40 °F to +158 °F)

### Vibration and Mechanical Shock

Vibration: 10 Hz to 55 Hz, 1.0 mm peak-to-peak amplitude per IEC 60068-2-6  
 Shock: 15G 11 ms duration, half sine wave per IEC 60068-2-27

### Operating Temperature

-40 °C to +50 °C (-40 °F to +122 °F) at the max. intensity setting  
 -40 °C to +70 °C (-40 °F to +158 °F) at any of the dim settings

### Environmental Rating

IEC IP67, JIS C IP68G, IP69K per DIN 40050-9

### Certifications



### Light Characteristics

Color temperature (CCT): 6200K (+500, -550K)  
 Color: Cool white

### Lumen Output

1300 lumens (typical at 25° C)  
 Luminous efficacy: 87 lumens/watts typical at 24 V dc at 25° C  
 CRI: 80, minimum

### LED Lifetime

Lumen Maintenance - L70  
 When operating within specifications, output will decrease less than 30% after 60,000 hours

### Spacing Criterion

0.86

### Test Data

LM-79, LM-80, TM-21

### Required Overcurrent Protection



**WARNING:** Electrical connections must be made by qualified personnel in accordance with local and national electrical codes and regulations.

Overcurrent protection is required to be provided by end product application per the supplied table.  
 Overcurrent protection may be provided with external fusing or via Current Limiting, Class 2 Power Supply.  
 Supply wiring leads < 24 AWG shall not be spliced.  
 For additional product support, go to [www.bannerengineering.com](http://www.bannerengineering.com).

Supply Wiring (AWG)	Required Overcurrent Protection (Amps)
20	5.0
22	3.0
24	2.0
26	1.0
28	0.8
30	0.5

## Performance

### Polar Candela Distribution

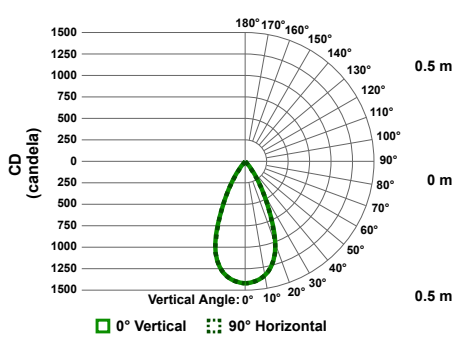

### Isolux Pattern

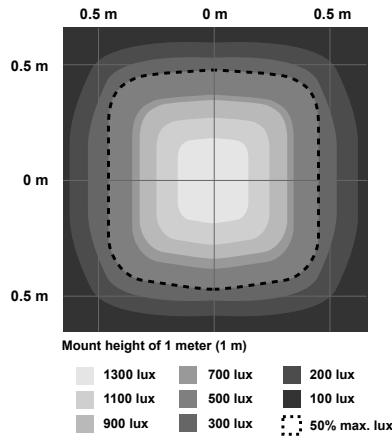

### Illuminance at a Distance

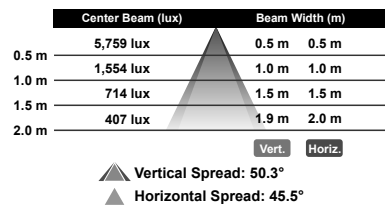

## Dimensions

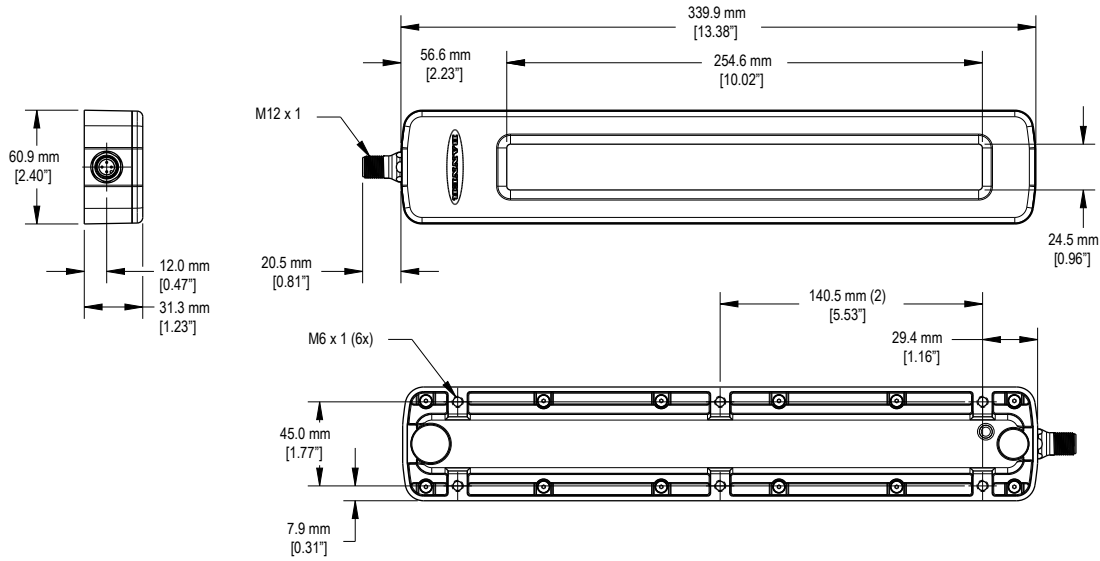

## Accessories

### Cordsets

4-Pin Threaded M12/Euro-Style Cordsets—Single Ended				
Model	Length	Style	Dimensions	Pinout (Female)
MQDC-406	1.83 m (6 ft)	Straight		<p>1 = Brown 2 = White 3 = Blue 4 = Black</p>
MQDC-415	4.57 m (15 ft)			
MQDC-430	9.14 m (30 ft)			
MQDC-450	15.2 m (50 ft)			
MQDC-406RA	1.83 m (6 ft)	Right-Angle		
MQDC-415RA	4.57 m (15 ft)			
MQDC-430RA	9.14 m (30 ft)			
MQDC-450RA	15.2 m (50 ft)			

4-Pin Threaded M12/Euro-Style Cordsets—Washdown, Stainless Steel, Single Ended				
Model	Length	Style	Dimensions	Pinout (Female)
MQDC-WDSS-0406	1.83 m (6 ft)	Straight		<p>1 = Brown 2 = White 3 = Blue 4 = Black</p>
MQDC-WDSS-0415	4.57 m (15 ft)			
MQDC-WDSS-0430	9.14 m (30 ft)			

## Brackets

All measurements are listed in millimeters, unless noted otherwise.

### LMBWLC60F

- Set of two flat brackets
- 300 series stainless steel
- Includes M6 flathead screws for mounting to light
- Clearance for M6 or 1/4-20 mounting hardware

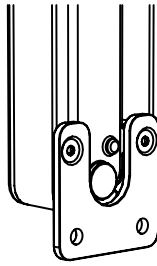

### LMBWLC60RA

- Set of two right-angle brackets
- 300 series stainless steel
- Includes M6 button head screws for mounting to light
- Clearance for M6 or 1/4-20 mounting hardware

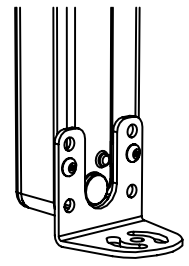

### LMBWLC60MAG

- Magnetic mounting kit (set of two)
- Two inch magnets
- Mounting hardware included

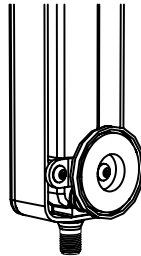

### LMBWLC60RAS

- Pair of two swivel mount, right-angle brackets
- 300 series stainless steel
- Includes hardware for mounting to light

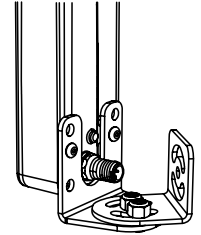

### LMBWLC60B340

- Plate for sealing the cavity on the back of the 340 mm models
- 300 series stainless steel
- Includes hardware for mounting to the light

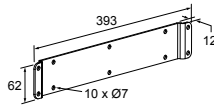

### ACC-WLC60-340-GSK-FDA-1

- Blue FDA-approved silicone gasket
- Thickness: 1.6 mm

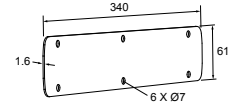

## Banner Engineering Corp. Limited Warranty

Banner Engineering Corp. warrants its products to be free from defects in material and workmanship for one year following the date of shipment. Banner Engineering Corp. will repair or replace, free of charge, any product of its manufacture which, at the time it is returned to the factory, is found to have been defective during the warranty period. This warranty does not cover damage or liability for misuse, abuse, or the improper application or installation of the Banner product.

**THIS LIMITED WARRANTY IS EXCLUSIVE AND IN LIEU OF ALL OTHER WARRANTIES WHETHER EXPRESS OR IMPLIED (INCLUDING, WITHOUT LIMITATION, ANY WARRANTY OF MERCHANTABILITY OR FITNESS FOR A PARTICULAR PURPOSE), AND WHETHER ARISING UNDER COURSE OF PERFORMANCE, COURSE OF DEALING OR TRADE USAGE.**

This Warranty is exclusive and limited to repair or, at the discretion of Banner Engineering Corp., replacement. **IN NO EVENT SHALL BANNER ENGINEERING CORP. BE LIABLE TO BUYER OR ANY OTHER PERSON OR ENTITY FOR ANY EXTRA COSTS, EXPENSES, LOSSES, LOSS OF PROFITS, OR ANY INCIDENTAL, CONSEQUENTIAL OR SPECIAL DAMAGES RESULTING FROM ANY PRODUCT DEFECT OR FROM THE USE OR INABILITY TO USE THE PRODUCT, WHETHER ARISING IN CONTRACT OR WARRANTY, STATUTE, TORT, STRICT LIABILITY, NEGLIGENCE, OR OTHERWISE.**

Banner Engineering Corp. reserves the right to change, modify or improve the design of the product without assuming any obligations or liabilities relating to any product previously manufactured by Banner Engineering Corp. Any misuse, abuse, or improper application or installation of this product or use of the product for personal protection applications when the product is identified as not intended for such purposes will void the product warranty. Any modifications to this product without prior express approval by Banner Engineering Corp will void the product warranties. All specifications published in this document are subject to change; Banner reserves the right to modify product specifications or update documentation at any time. Specifications and product information in English supersede that which is provided in any other language. For the most recent version of any documentation, refer to:

[www.bannerengineering.com](http://www.bannerengineering.com).

For patent information, see [www.bannerengineering.com/patents](http://www.bannerengineering.com/patents).

## Mexican Importer

Banner Engineering de México, S. de R.L. de C.V.  
David Alfaro Siqueiros 103 Piso 2 Valle oriente  
San Pedro Garza Garcia Nuevo León, C. P. 66269

81 8363.2714