

| FINISH TYPE | "0" TIN | "1" 15MICROINCH GOLD | "2" 30MICROINCH GOLD | | | | |
|-------------|-------------|----------------------|----------------------|-------|-------|-------|-------|
| CKT | HDR ASSY PN | HDR ASSY PN | HDR ASSY PN | A | B | C | D |
| 2 | 2189890230 | 2189890231 | 2189890232 | 9.65 | 3.00 | 7.30 | 2.95 |
| 3 | 2189890330 | 2189890331 | 2189890332 | 12.65 | 6.00 | 10.30 | 2.95 |
| 4 | 2189890430 | 2189890431 | 2189890432 | 15.65 | 9.00 | 13.30 | 7.70 |
| 5 | 2189890530 | 2189890531 | 2189890532 | 18.65 | 12.00 | 16.30 | 10.70 |

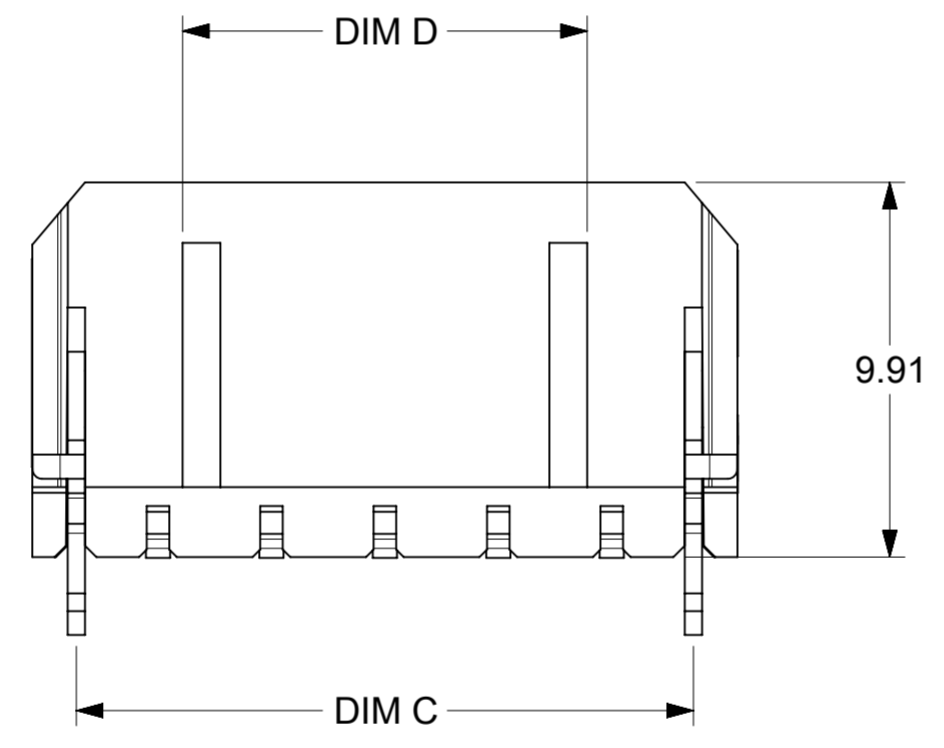
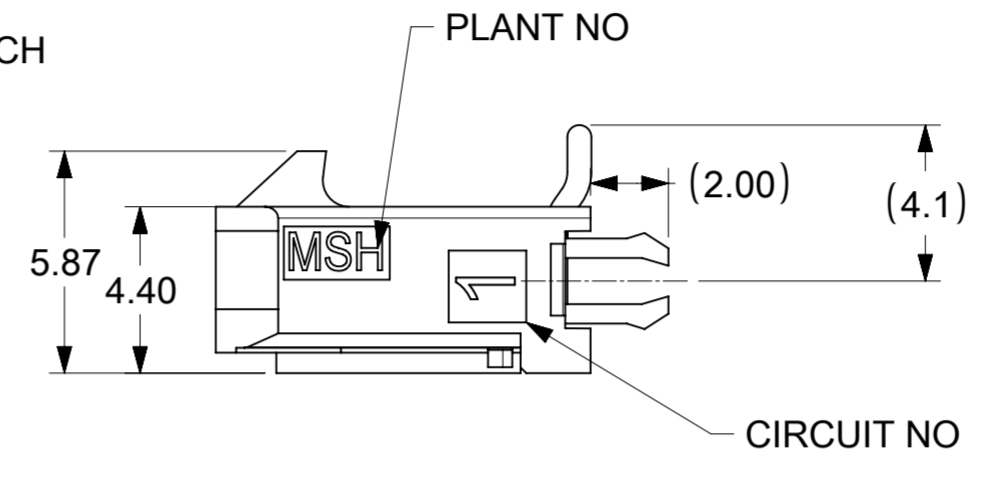
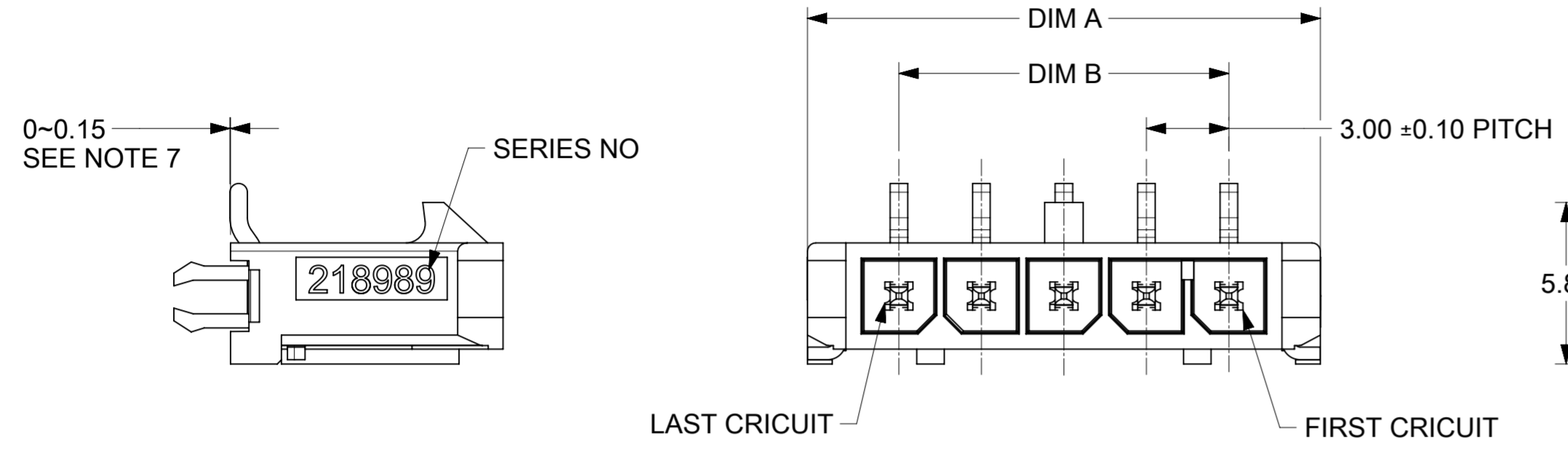

LEGEND

218989 - * * * *

SERIES NO. _____

CKT NO. _____

OPTION

0: RIGHT ANGLE WITH NAIL

1: RIGHT ANGLE WITH CLIP

2: VERTICAL WITH NAIL

3: VERTICAL WITH CLIP

PLATING OPTION

0: TIN

1: 15MICROINCH AU

2: 30MICROINCH AU

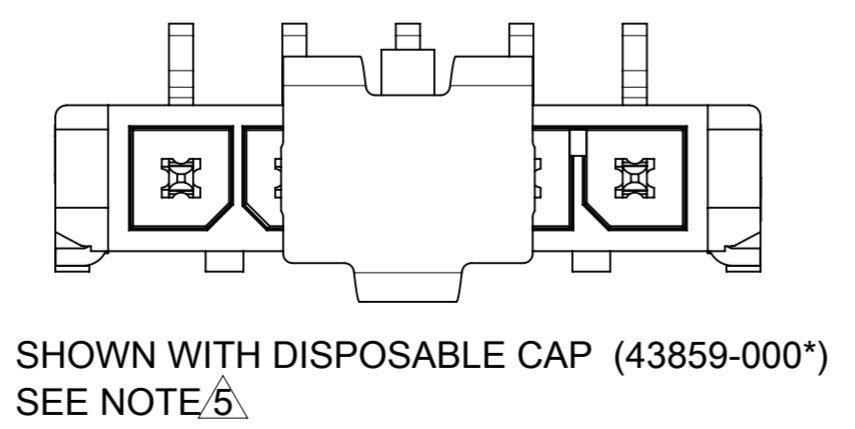

- NOTES:**
- HOSING MATERIAL: GLASS FILLED LIQUID CRYSTAL POLYMER, UL 94V-0, COLOR: BLACK
TERMINAL MATERIAL: HIGH COPPER ALLOY
 - FINISH:
OPTION "0": REFLOW MATTE TIN OVER NICKEL
OPTION "1": SELECT 15MICROINCH GOLD AND SELECT MATTE TIN OVER NICKEL.
OPTION "2": SELECT 30MICROINCH GOLD AND SELECT MATTE TIN OVER NICKEL.
 - PRODUCT SPECIFICATION : 2064600000-PS
 - PRODUCT TEST SUMMARY: 2064600000-TS
 - T&R PACK : 2189890001-PK
 - MATE WITH RECEPTACLE 215759
 - THE COPLANARITY DIMENSION IS ESTABLISHED BY PLACING THE ASSEMBLY ON A FLAT SURFACE. THE DISTANCE FROM THAT SURFACE TO THE BOTTOM OF ANY TERMINAL OR NAIL MUST NOT EXCEED 0.15
 - THIS PART CONFORMS TO CLASS 'B' REQUIREMENTS OF COSMETIC SPECIFICATION PS-45499-002.

| | | | | | | | | | | | | | | | | | |
|---|--|--------|--|---|--|---------|--|---------|--|--|--|----------------|--|---------------|--|--------------------------------|--|
| THIS DRAWING CONTAINS INFORMATION THAT IS PROPRIETARY TO MOLEX ELECTRONIC TECHNOLOGIES, LLC AND SHOULD NOT BE USED WITHOUT WRITTEN PERMISSION | | | | | | | | | | | | | | | | | |
| DIMENSION UNITS | | SCALE | | CURRENT REV DESC: | | | | | | molex | | | | | | | |
| mm | | NTS | | | | | | | | | | | | | | | |
| GENERAL TOLERANCES (UNLESS SPECIFIED) | | | | EC NO: 724761 DRWN: ZIXUAQ 2022/09/08 CHK'D: XQZHANG 2022/10/17 APPR: XQZHANG 2022/10/17 INITIAL REVISION: DRWN: ZIXUAQ 2022/09/08 APPR: XQZHANG 2022/10/17 | | | | | | MICRO-FIT + SINGLE ROW VERTICAL SMT HEADER WITH PRESS CLIP | | | | | | | |
| ANGULAR TOL | | ± 3.0° | | | | | | | | PRODUCT CUSTOMER DRAWING | | | | | | | |
| 4 PLACES | | ± | | | | | | | | DOCUMENT NUMBER | | | | 2189890030-SD | | DOC TYPE DOC PART REVISION | |
| 3 PLACES | | ± | | | | | | | | PSD | | | | 000 | | A | |
| 2 PLACES | | ± 0.25 | | | | | | | | MATERIAL NUMBER | | | | SEE TABLE | | | |
| 1 PLACE | | ± 0.36 | | DRAWING | | | | A2-SIZE | | | | | | | | | |
| 0 PLACES | | ± | | SERIES | | | | 218989 | | | | | | | | | |
| DRAFT WHERE APPLICABLE MUST REMAIN WITHIN DIMENSIONS | | | | THIRD ANGLE PROJECTION | | DRAWING | | SERIES | | MATERIAL NUMBER | | CUSTOMER | | SHEET NUMBER | | | |
| | | | | | | A2-SIZE | | 218989 | | SEE TABLE | | GENERAL MARKET | | 1 OF 2 | | | |

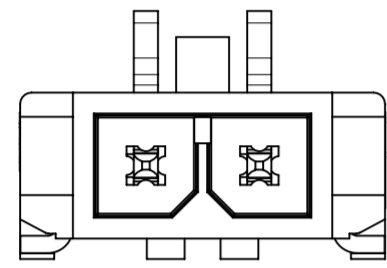

2CKT

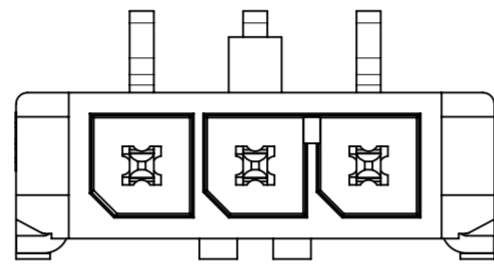

3CKT

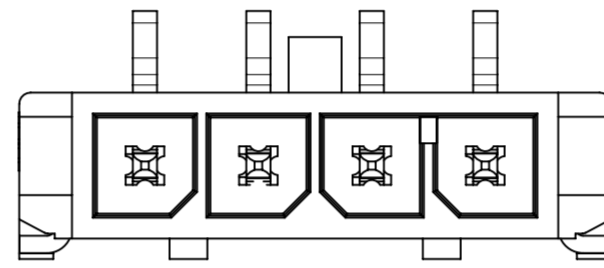

4CKT

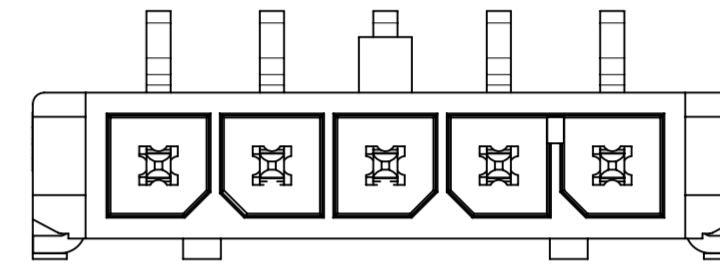

5CKT

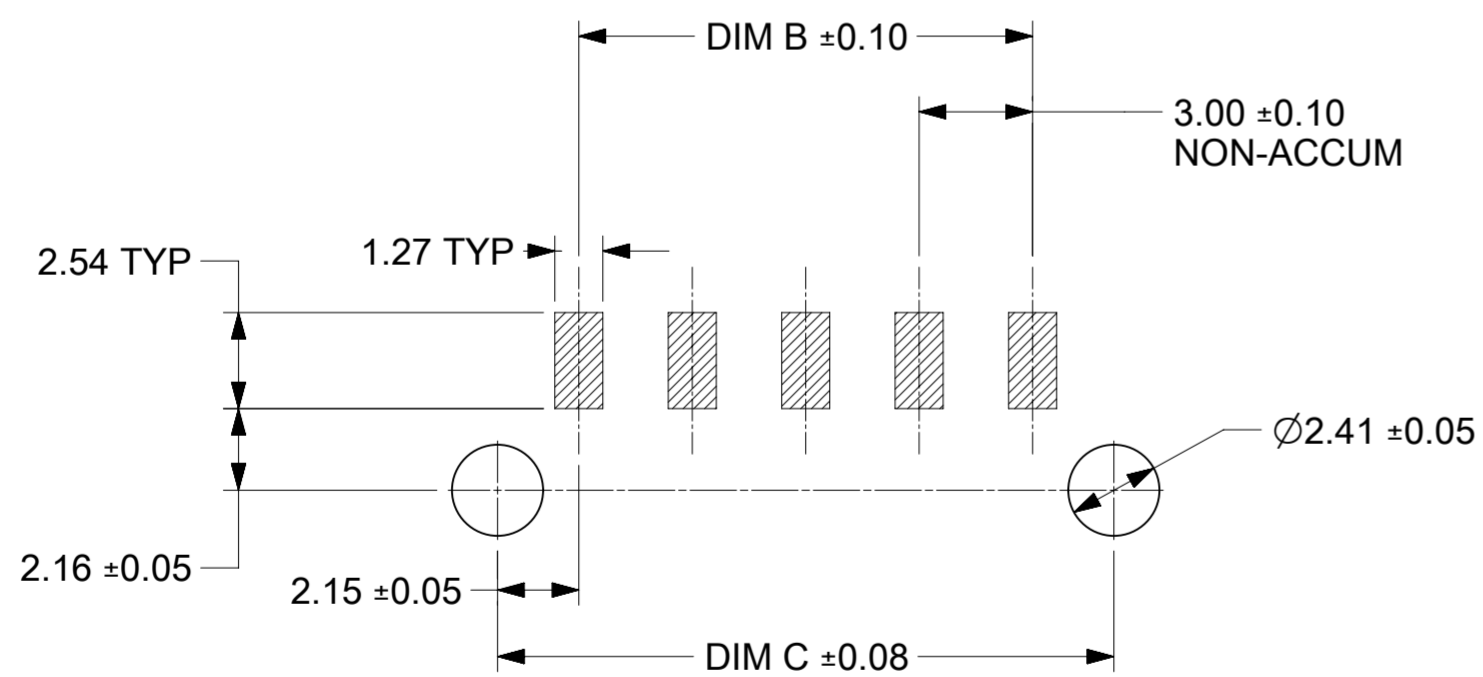

PCB LAYOUT: COMPONENT SIDE
RECOMMENDED THICKNESS :1.60 ±0.05MM

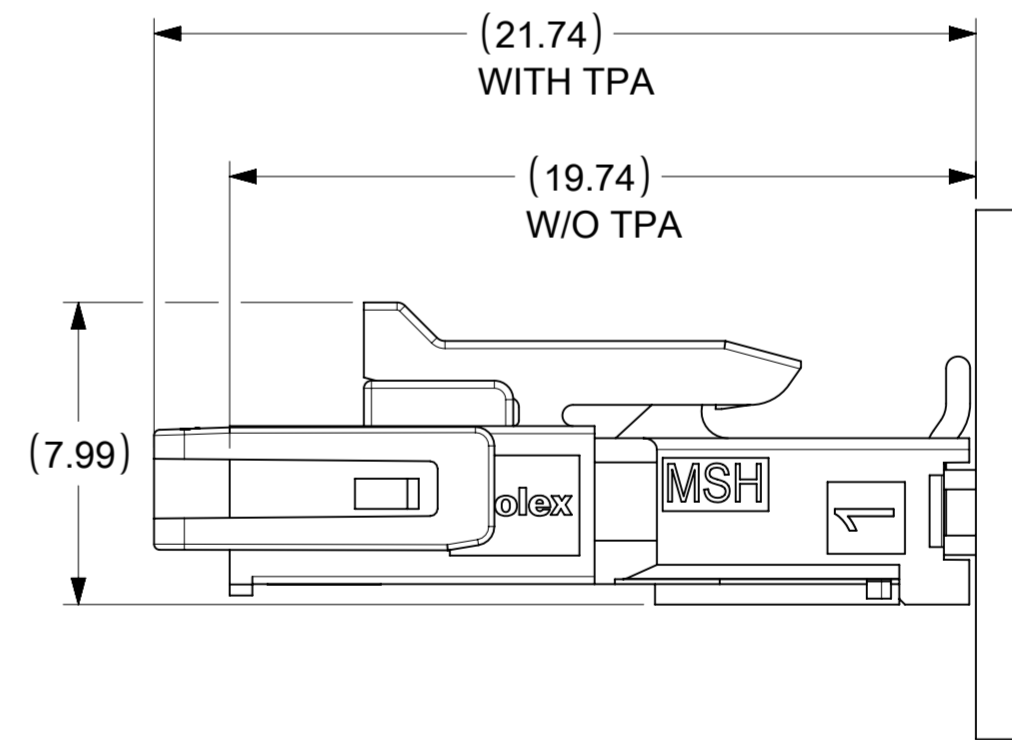

| | | | | | | | | | |
|---|------------------------|---------------------------|----------------|--|---|--|--|--|--|
| THIS DRAWING CONTAINS INFORMATION THAT IS PROPRIETARY TO MOLEX ELECTRONIC TECHNOLOGIES, LLC AND SHOULD NOT BE USED WITHOUT WRITTEN PERMISSION | | | | | | | | | |
| DIMENSION UNITS | SCALE | CURRENT REV DESC: | | | | | | | |
| mm | NTS | | | | | | | | |
| GENERAL TOLERANCES (UNLESS SPECIFIED) | | EC NO: 724761 | | | MICRO-FIT + SINGLE ROW VERTICAL SMT HEADER WITH PRESS CLIP | | | | |
| ANGULAR TOL | ± 3.0° | DRWN: ZIXUAQ 2022/09/08 | | | | | | | |
| 4 PLACES | ± | CHK'D: XQZHANG 2022/10/17 | | | PRODUCT CUSTOMER DRAWING | | | | |
| 3 PLACES | ± | APPR: XQZHANG 2022/10/17 | | | | | | | |
| 2 PLACES | ± 0.25 | INITIAL REVISION: | | | DOCUMENT NUMBER: 2189890030-SD DOC TYPE: PSD DOC PART: 000 REVISION: A | | | | |
| 1 PLACE | ± 0.36 | DRWN: ZIXUAQ 2022/09/08 | | | | | | | |
| 0 PLACES | ± | APPR: XQZHANG 2022/10/17 | | | MATERIAL NUMBER: SEE TABLE CUSTOMER: GENERAL MARKET SHEET NUMBER: 2 OF 2 | | | | |
| DRAFT WHERE APPLICABLE MUST REMAIN WITHIN DIMENSIONS | THIRD ANGLE PROJECTION | DRAWING: A2-SIZE | SERIES: 218989 | | | | | | |

| | | | | |
|-----------------|----|--------------|------------|----------|
| DOCUMENT STATUS | P1 | RELEASE DATE | 2022/10/17 | 06:34:13 |
|-----------------|----|--------------|------------|----------|