

# EVALUATION KIT

## GRID-EYE SENSOR

# Panasonic



# AGENDA

1. Introduction
2. Specifications
3. Interfaces
4. Software for Evaluation Kit
5. Evaluation Kit Package

# INTRODUCTION

## Evaluation Kit Grid EYE

- Grid-EYE Infrared (IR) Array sensor Evaluation Kit combines the following components on a single board:
  - Panasonic's state of the art Grid-EYE sensor
  - Panasonic "nanopower" PAN1740 Bluetooth Smart module
  - Atmel Microcontroller
- By combining new IR sensor technology with Bluetooth technology and software for IR detection of people and objects on one board, Panasonic enables customers to develop rapid prototypes and quickly build their own applications within no time.
- To make it simpler and easier for the user, Panasonic has been flexible in the development of this evaluation kit. The board functions in a standalone mode or it can be connected to an Arduino host board if the user wants to realize the functionality of the sensor with more than the provided interfaces.

# INTRODUCTION

## Overview Evaluation Kit

- Below you can see how the evaluation kit looks like and a brief description of its components.

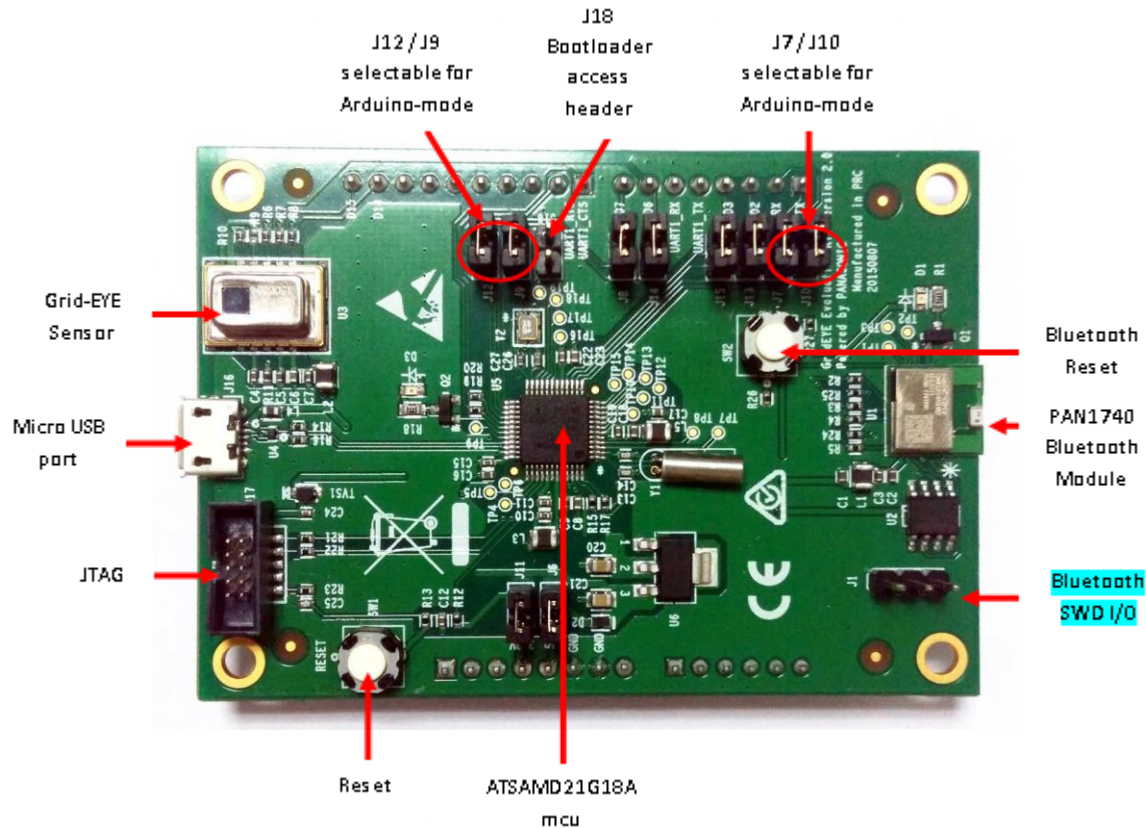

# SPECIFICATIONS

# SPECIFICATIONS

## Evaluation Kit Specifications

| Item               | Description                          |
|--------------------|--------------------------------------|
| Part No.           | AMG8832EK                            |
| Sensor             | AMG 8832 - Grid-EYE Infra-red sensor |
| Wireless Interface | Bluetooth Module PAN1740             |
| Microcontroller    | ATSAMD21                             |
| Wired Interface    | Micro USB 2.0                        |
| Power Supply       | Micro USB 5V                         |

## Components of Evaluation Kit

- As mentioned earlier following are the major components of the evaluation kit:
  - Grid-EYE Sensor
  - ATSAM21- SMART ARM-Based Microcontroller
  - Bluetooth Module PAN1740
  
- In the next slides you will see the technical details of each of these components.



# SPECIFICATIONS

## Grid-EYE Sensor

| Specification                           | Value  |
|---|--|
| Power voltage                           | 3.3V $\pm$ 10%                                 |
| Current consumption                     | 4.5mA (normal), 0.8mA (standby), 0.2mA (sleep) |
| View angle                              | 60 degrees (x,y)                               |
| Absolute temperature accuracy           | Low gain: $\pm$ 3.0°C (typ.)                   |
| Noise Equivalent Temperature Difference | 0.5°C @ 10Hz                                   |
| Frame rate (selectable):                | 1 frame/sec or 10 frames/sec                   |
| External interface                      | I <sup>2</sup> C (12bit)                       |
| Operation mode                          | Normal, Standby, Sleep (Selectable)            |
| Number of Pixel                         | 64 - (Vertical 8 x Horizontal 8 Matrix)        |

# SPECIFICATIONS

## ATSAMD21- SMART ARM-Based Microcontroller

| Item               | Description  |
|--------------------|--|
| CPU Core           | Cortex-M0+   |
| Max. CPU frequency | 48MHz  |
| ROM                | 256K   |
| RAM                | 32K  |
| USB                | Full-speed USB 2.0 (Support USB Host and USB device) |
| I <sup>2</sup> C   | Up to 3.4MHz   |
| UART               | Up to 3.4MHz   |
| Power Supply       | 1.62V to 3.63V                                       |

# SPECIFICATIONS

## Bluetooth Module PAN1740

| Item                  | Description  |
|-----------------------|--|
| CPU Core              | Cortex-M0  |
| CPU frequency         | 16MHz or 32.768KHz   |
| Power Consumption     | Max power consumption: 4.9mA (TX and RX).                                    |
| Bluetooth             | Embedded BLE Stack and GATT Profile, qualified to the Bluetooth 4.0 standard |
| Operating Temperature | -40°C to 85°C  |
| Gain                  | 93dBm  |

# INTERFACES

## Interfaces on the Evaluation Kit

- The following diagram shows all the interfaces on the evaluation kit for Grid-EYE.
- They include the communication interfaces as well as development interfaces.

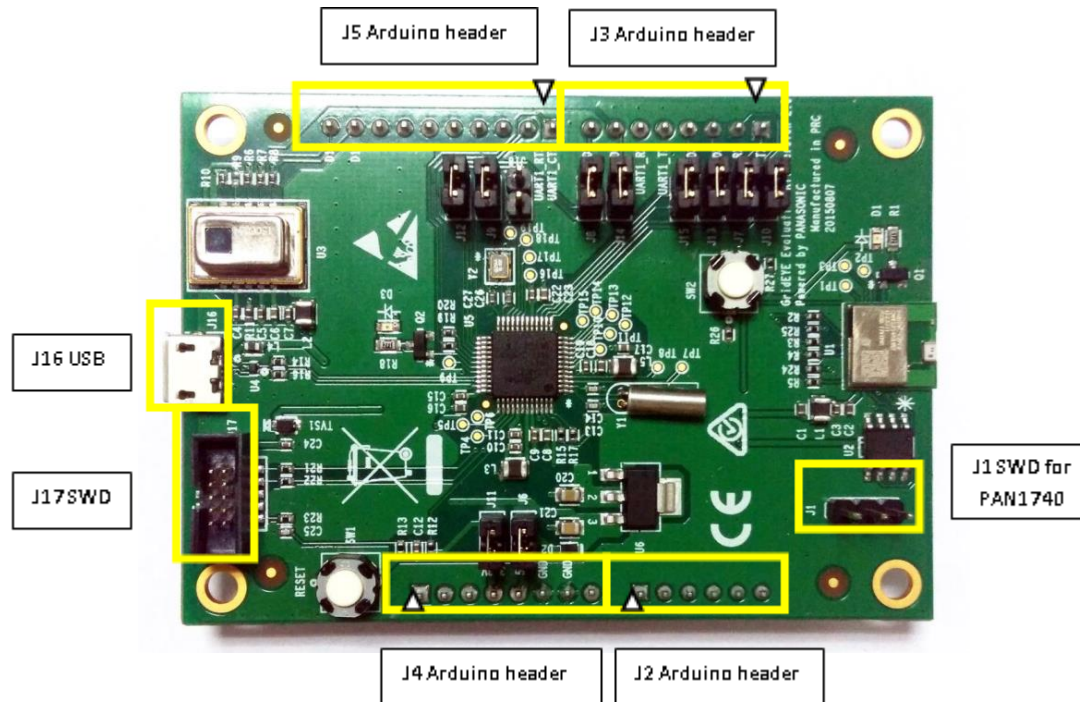

# SOFTWARE FOR EVALUATION KIT

## Software for the Evaluation Kit

- Panasonic is also providing the customers with three options for software to use with the evaluation kit:
  - Software for PC
  - DSPS Bluetooth App for Smart phones
  - Application for iOS Smartphones (Coming soon)
  - Application for Android Smartphone (Coming soon)
- The purpose of these basic functionality software is to allow the customers to realize the potential of the Grid-EYE sensor as a product and to use these as a base for their future development.
- All the software is open source and all the codes are open and accessible to our customers of evaluation kit.
- To download the software or the source codes, please visit the Panasonic website:  
<http://eu.industrial.panasonic.com/grideye-evalkit>

## PC Software

- The PC software allows the user to get the following data from the Grid-EYE sensor on evaluation kit:
  - Temperature values for 64 pixels grid
  - Interpolated image from the temperature values

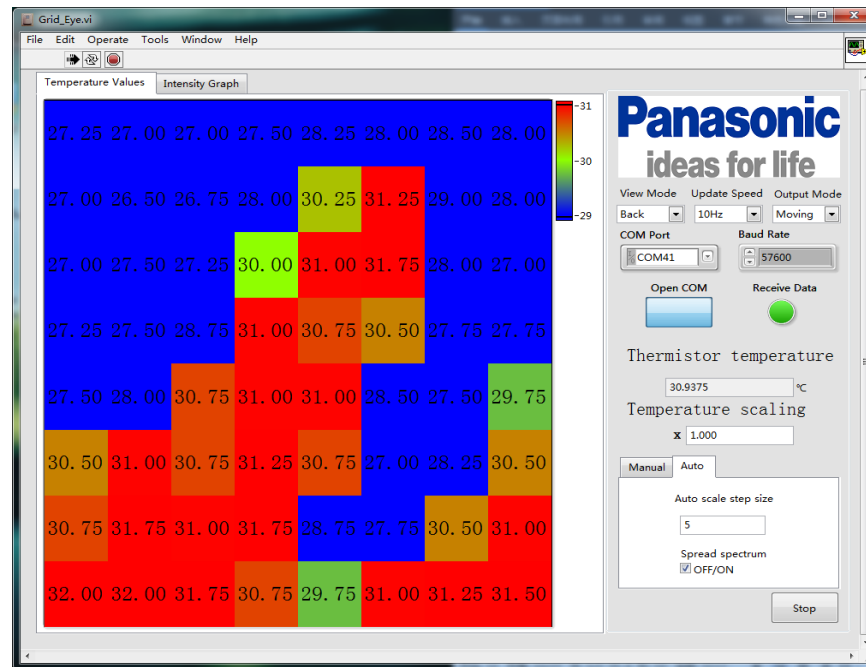



## Interpolated View

- The following picture shows how the interpolated view looks like in the software.

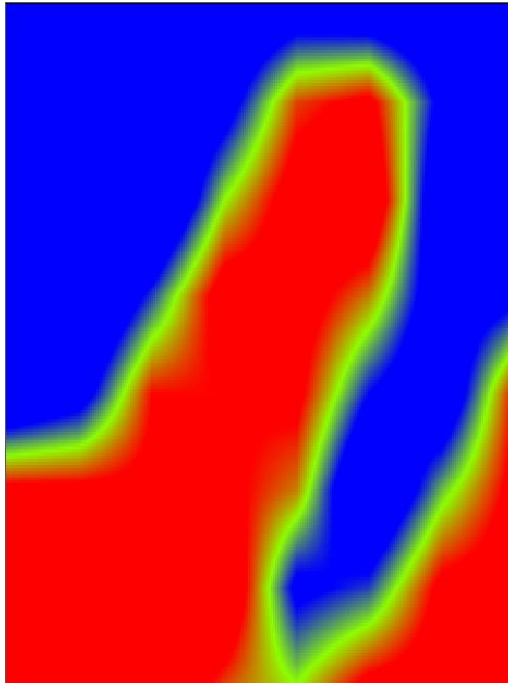
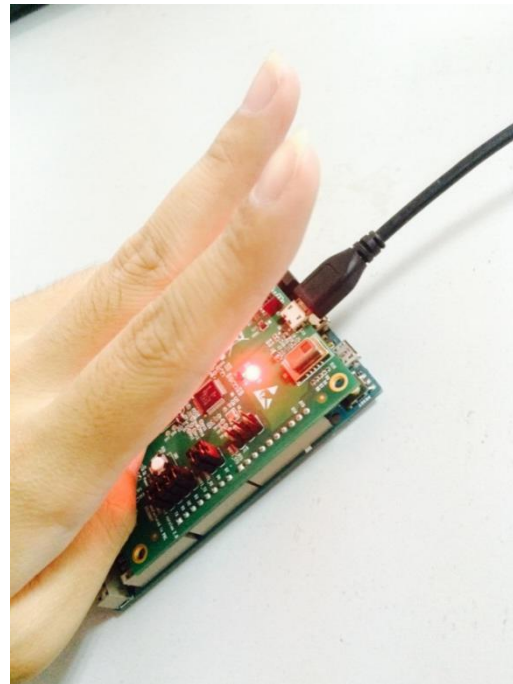

Image after smoothing



Original image

## DSPS Application for Smart Phone

- As the smartphone applications will be available soon, until then the customer can use the DSPS app to get the data from the Grid-EYE sensor on the evaluation board. This would like the following.

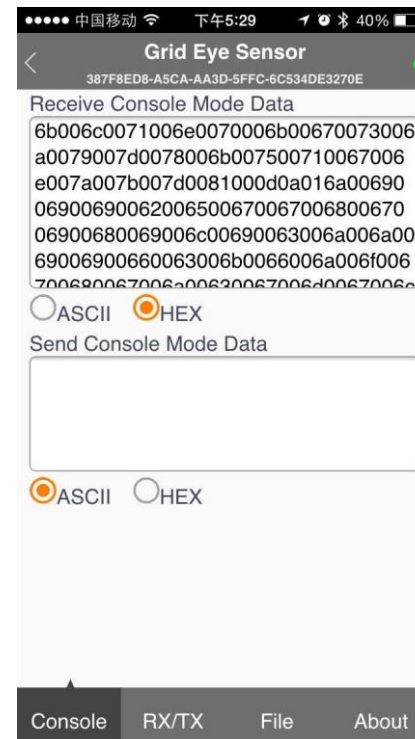
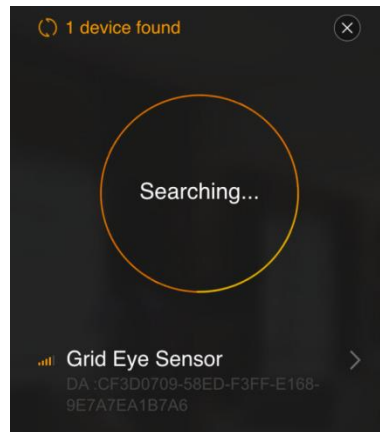

# EVALUATION KIT PACKAGE

# Evaluation Kit Package

## Package from Outside



Top side

Bottom side



# Evaluation Kit Package

## Package from Inside



Inside design with a Leaflet

Backside of leaflet

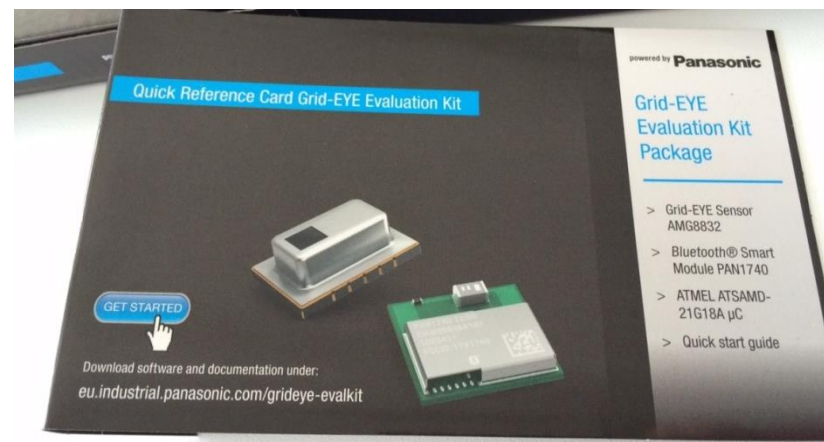



# Evaluation Kit Package

## Contents of the Package

Board top side

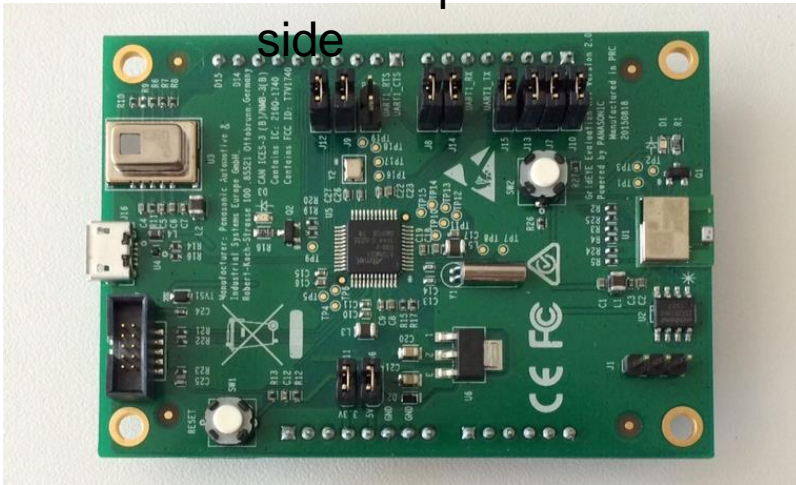

Board bottom side

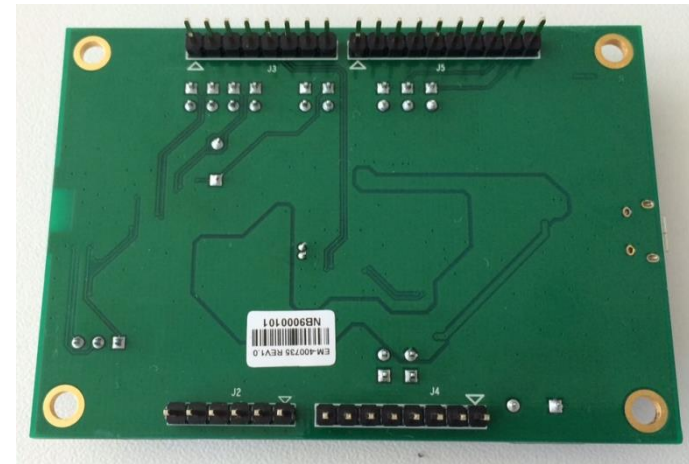

Micro USB Cable



Safety instructions

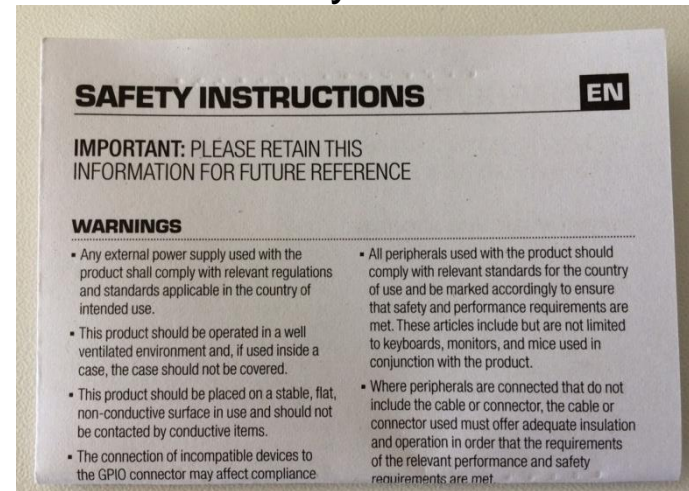

## Interested in the Evaluation kit?

Please contact us via Panasonic sales or the following:

Mubeen Abbas

Product Marketing Manager

[grideye@eu.panasonic.com](mailto:grideye@eu.panasonic.com)

Robert-Koch-Strasse 100 · 85521 Ottobrunn