

Qty Per:	TRAY	CARTON		
	6	36		
PART NUMBER	STATEMENT			
SFPP-3126-L	SFP PLUS/INNER&OUTER LIGHT PIPES			
	SFP PLUS/INNER LIGHT PIPES			
	SFP PLUS/OUTER LIGHT PIPES			
No.	DESCRIPTION	Q'ty	MATERIAL	PLATING
01	SFP CAGE (Non-Logo)	1	COPPER ALLOY	
02	CONNECTOR	4	HIGH TEMP/COPPER ALLOY	GOLD
03	LIGHT PIPES	4	POLYCARBONITE	
04	EMI GASKET	1	CONDUCTIVE POLYMER	

DETACHED LISTS	MM (INCH)	RoHS Compliant		
	TOLERANCES EXCEPT AS NOTED			
	.0 ± 0.25 ± .00 ± 0.20 ± .000 ± 0.10 ±			
ANGLES ± 0.5	TITLE		W/LIGHT PIPES&GASKET	
THIRD ANGLE PROJECTION	DFTD Jack		DRAWING NO. CSFPP-3126-L	
	DATE 7/24/09'		/PART NO. SFPP-3126-L	
	SCALE : 2:1		SHEET 1 OF 4	
			DO NOT SCALE DRAWING	
			SIZE A3 REV 0	

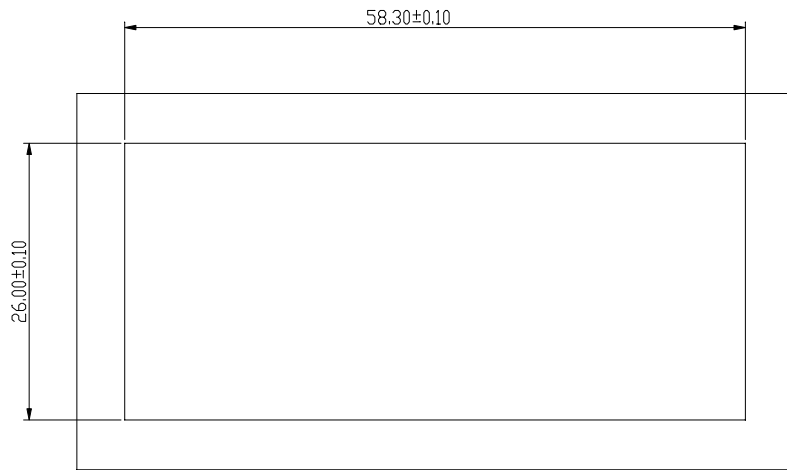

BEZEL CUT-OUT CENTER SPACING DETAIL
BEZEL THICKNESS:0.8-2.6

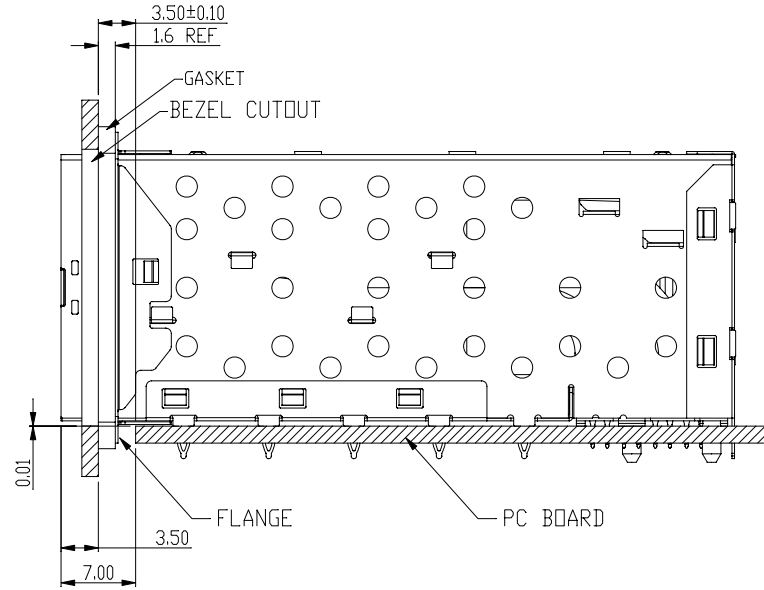

DETACHED LISTS		RoHS Compliant									
	TOLERANCES EXCEPT AS NOTED				TITLE						
	<table border="1" style="font-size: small;"> <tr><td>MM</td><td>±</td></tr> <tr><td>.0 ± 0.25</td><td>±</td></tr> <tr><td>.00 ± 0.20</td><td>±</td></tr> <tr><td>.000 ± 0.10</td><td>±</td></tr> </table>	MM	±	.0 ± 0.25	±	.00 ± 0.20	±	.000 ± 0.10	±	W/LIGHT PIPES&GASKET	
	MM	±									
.0 ± 0.25	±										
.00 ± 0.20	±										
.000 ± 0.10	±										
ANGLES ± 0.5	SFP PLUS 2 BY 4 CAGE+CONNECTOR_P		SIZE	REV							
	DFTD Jack	DRAWING NO. CSFPP-3126-L		A3							
THIRD ANGLE PROJECTION	DATE 7/24/09'	/PART NO. SFPP-3126-L		0							
	SCALE : 2:1	DO NOT SCALE DRAWING		SHEET 2 OF 4							

8

7

6

5

4

3

2

1

H
G
F
E
D
C
B
A

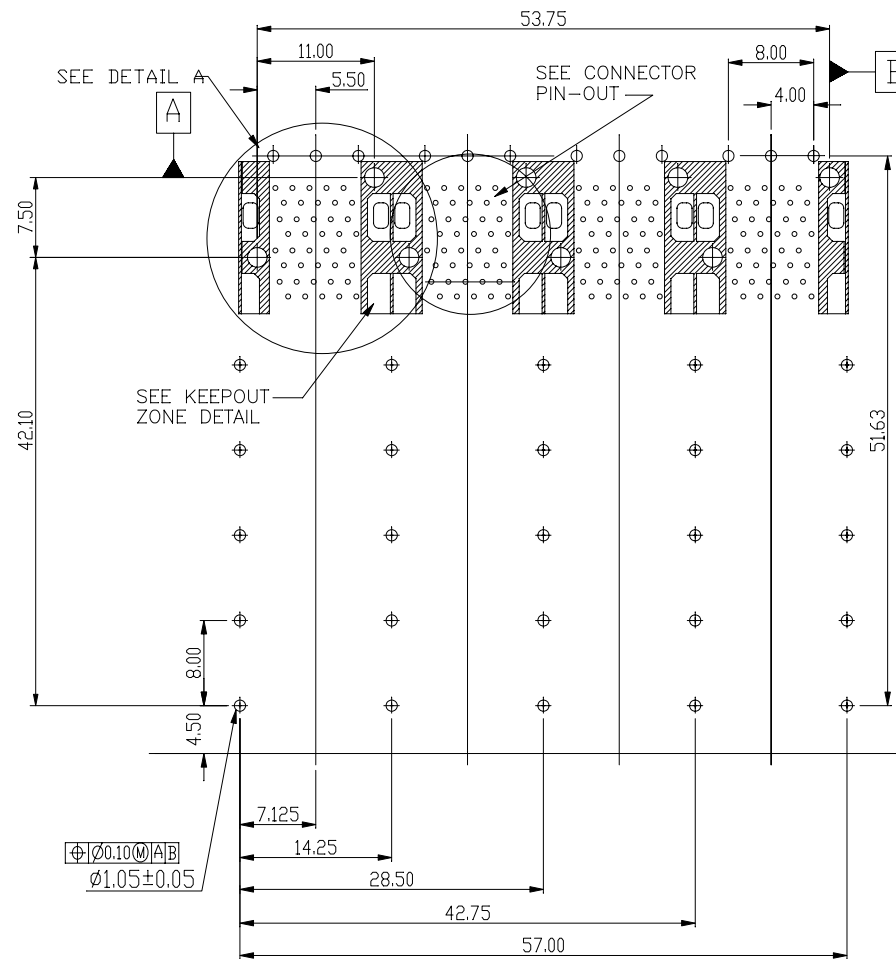
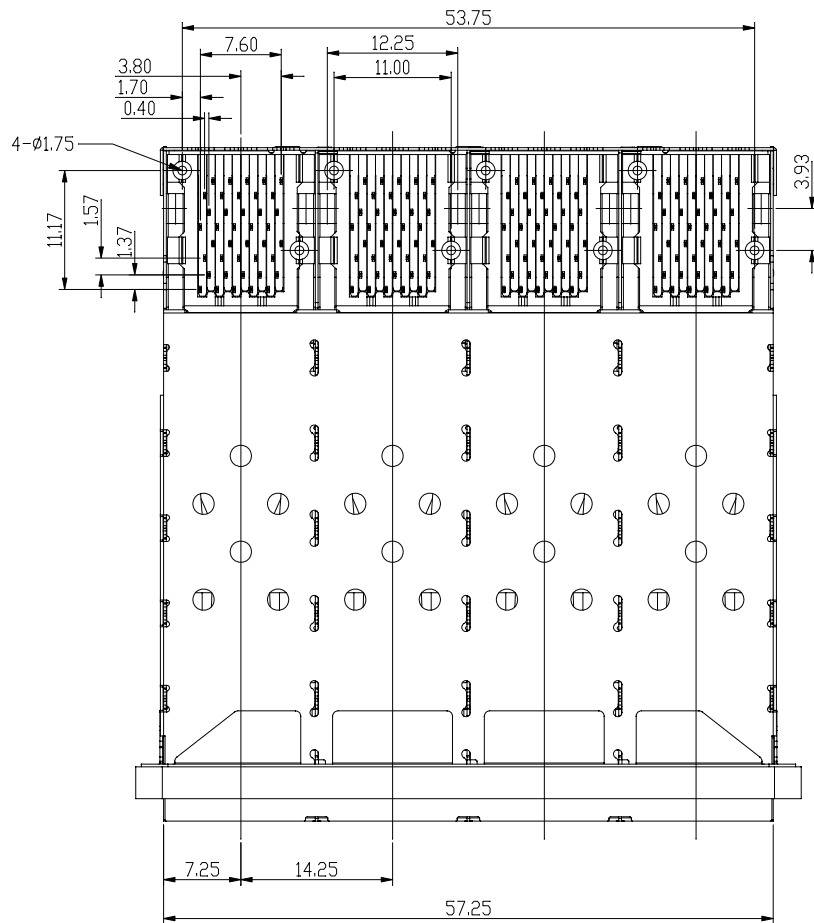

DETACHED LISTS	← MM (INCH) →	RoHS Compliant			
	TOLERANCES EXCEPT AS NOTED				TITLE
	MM	±	SFP PLUS 2 BY 4 CAGE+CONNECTOR_P		W/LIGHT PIPES&GASKET
	.0 ± 0.25	±	DFTD Jack	DRAWING NO. CSFPP-3126-L	SIZE
.00 ± 0.20	±	DATE 7/24/09'	/PART NO. SFPP-3126-L	A3	0
.000 ± 0.10	±	SCALE : 2:1		DO NOT SCALE DRAWING	SHEET 3 OF 4
ANGLES ± 0.5					
		THIRD ANGLE PROJECTION			

H
G
F
E
D
C
B
A

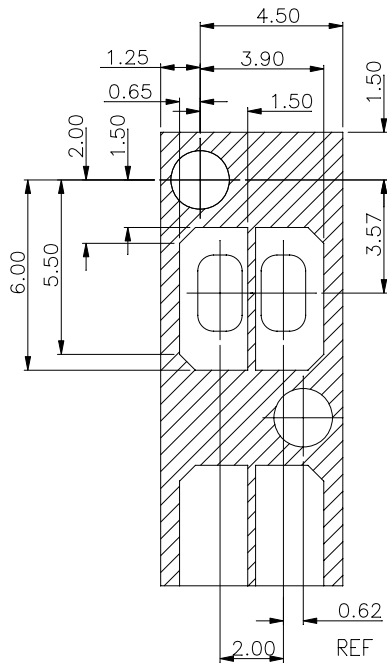

KEEP-OUT ZONE DETAIL
SCALE 6:1

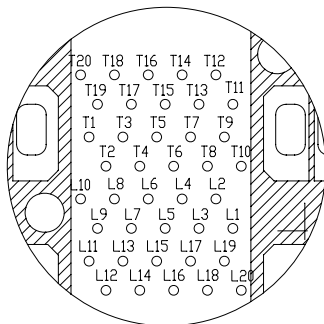

CONNECTOR PIN-OUT
COMPONENT SIDE OF BOARD

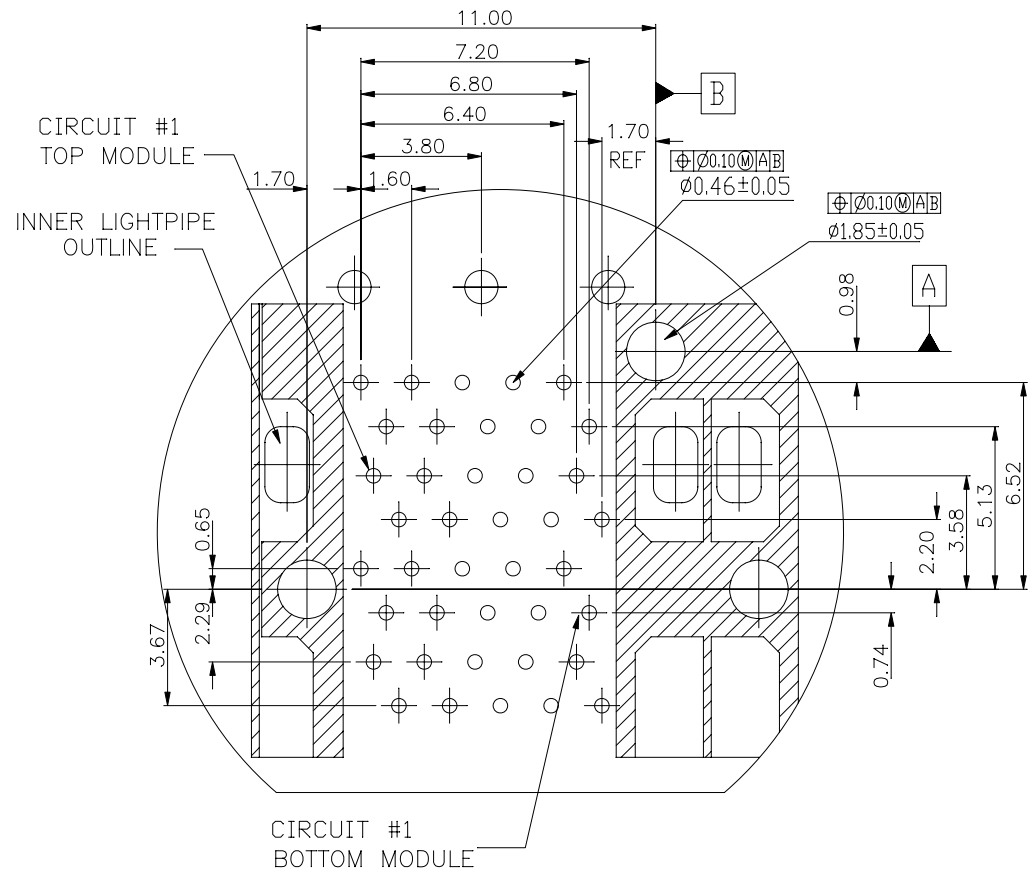

CIRCUIT #1
BOTTOM MODULE
DETAIL A
SCALE 6:1

DETACHED LISTS	MM (INCH)	RoHS Compliant		TITLE		SIZE	REV
	TOLERANCES EXCEPT AS NOTED			W/LIGHT PIPES&GASKET		A3	0
	.0 ± 0.25 ±	SFP PLUS 2 BY 4 CAGE+CONNECTOR_P		DFTD Jack	DRAWING NO. CSFPP-3126-L		
	.00 ± 0.20 ±	SCALE : 2:1		DATE 7/24/09'	/PART NO. SFPP-3126-L	DD NOT SCALE DRAWING	SHEET 4 OF 4
.000 ± 0.10 ±	THIRD ANGLE PROJECTION						
ANGLES ± 0.5							

8

7

6

5

4

3

2

1

H
G
F
E
D
C
B
A